



WWW.LEUTRON.DE

LIGHTNING AND SURGE PROTECTION





Leutron Main Catalogue 2016

We reserve the right to make alterations in style and form in line with technical development.
The illustrations are non-binding. We do not assume liability for mistakes of printing errors.
Reprint, even in extracts, only with approval of the Leutron GmbH.

© Leutron GmbH 2015, 2nd Edition 11/2015. P/N 98 01 86



■ Surge protection for power supply systems 2		AC Combined arrester type 1 + 2 + 3 (class I+II+III)	27
Selection guide PowerPro	6	SPD type 2 (class II) for AC power supplies	33
Selection guide EL series	8	SPD type 3 (class III) for AC power supplies	43
AC Power supply	10	DC Power supply	50
AC Lightning current arrester type 1 (class I)	12	Arresters for Photovoltaic Installations	54
AC Combined arrester type 1 + 2 (class I+II)	17	Accessories	60
■ Surge protection for measuring systems and automatic control devices 62		... for high frequency	80
Selection guide for interfaces	66	One-piece SPD for MCR applications	82
Test Categories for communication technology	69	... for high frequency	82
Pluggable SPD for MCR applications	70	... with high discharge capability	84
... with high discharge capability	70	... with high discharge capability and low protection level	85
... with high discharge capability and low protection level	71	... with low protection level	89
■ Surge protection for information technology and telecommunication installations 94		MCR protection field technology	93
SPD for communication networks	98	SPD of the Test Category D1 + C2	104
SPD for telecommunication networks	102	Magazines for HVT 71	106
Surge protective devices for LSA mounting	103	SPD of the Test Category C2 + C1	108
■ Surge protection for transmitting and receiving systems 116		LSA Accessories	115
SPD with BNC connector	120	Lambda/4 stubline SPD with N connector	122
SPD with SMA connector	121	SPD with DIN 7/16 connector	123
SPD with FME connector	121	SPD with N connector	125
■ EMC filter with integrated surge protection 128		SPD for SAT/TV/Radio applications	127
Line filter up to 200A, DIN rail mounting	132	Line filter up to 200A, 2 pole and 4 pole	133
■ Monitoring 146		MCR with low pass filter	136
Function tester for GDT and GDT based spark-gaps	150	Portable test equipment for GDT in LSA magazines	151
■ Rare-gas-filled insulation spark gaps 154		Pulse counter	152
Flexible mounting	158	for hazardous area ATEX	162
■ Protective devices for AC application 166		DIN rail mounting	164
AC-current diverter up to AC 80A with lightning protection	170	Arresters for Cathodic Corrosion Protection Systems	171
■ Surge Protection of PV systems: Generator Connection Boxes 174		Protection system of CCP	172
GAK without string fuses	178	GAK with reverse current fuse	189
Protection of inverter AC side	187	Special editions of GAK	191
Complete protection of inverter	188	Accessories	192
Standards		Overview surge protection PV systems	193
Dimension Drawings		Technical Terms	201
Installation Remarks		Product Register numeric	205
		Product Register alphabetical	211

SURGE PROTECTION WITH A NEW DESIGN

The multi-pole combined modular arresters for protection against lightning strikes and transient surge voltages now have an even more attractive design. In addition to their outstanding technical properties, they are pluggable and provide a clearly readable function control indication and status display. The variable installation position – the base part can be plugged in two directions – enables a flexible and cost-saving wiring.



EASY SETUP, SECURE OPERATION:

- New: Easy changing of the protection module thanks to a two-part design with a vibration-resistant locking
- Remote signalling using only one signalling contact – even with 4-pole devices
- Robust and maintenance-free due to the hermetically closed rare-gas-filled isolating spark gap without internal or external trigger electronics





The new design developed together with product design specialists allows for an easier handling.

SURGE PROTECTION FOR POWER SUPPLY SYSTEMS

TWO-PIECE PLUGGABLE SURGE PROTECTIVE DEVICES FOR AC POWER SUPPLY SYSTEMS

New product line »Leutron Power«: Powerful and standardized pluggable modules for almost every power supply system available.

- Optimized follow-on current extinguishing capability

Mechanical status indicator: State of the surge protective device is optically indicated

Locking function: Release of the latches by ergonomically shaped grip lugs

Protection against mismatching: Optimized installation due to arresters with coding

Remote signalling: Combined remote contact (changeover contact) optionally available

Turnable plug-in modules: The plug-in modules can be twisted on the basic module, thus, guaranteeing always good readability even with variable wiring

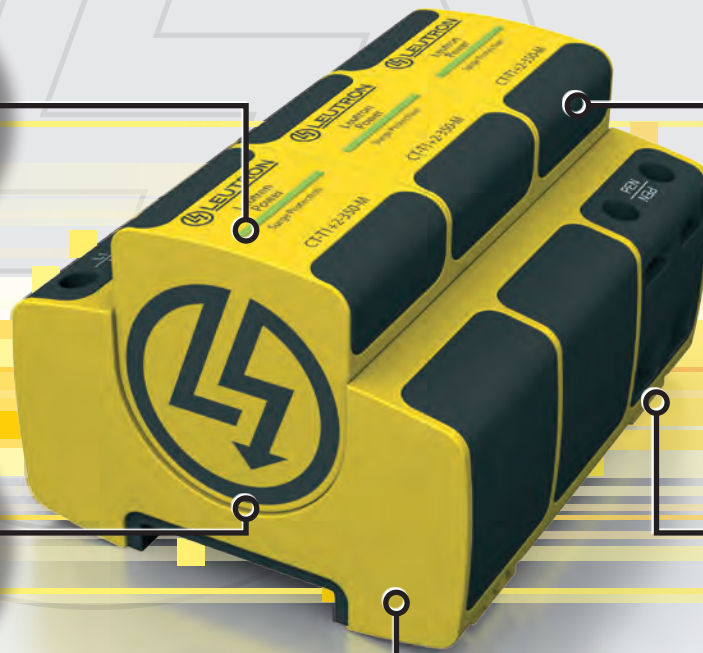



TWO-PIECE PLUGGABLE SURGE PROTECTIVE DEVICES FOR DC POWER SUPPLY SYSTEMS

Mechanical status indicator:
State of the surge protective device is optically indicated

Arrester elements
available for 600 V and
1,000 V applications

Safety for
PV installations:
Disconnection
function in case of over-
loads optimized for
photovoltaic systems

Remote
signalling:
Combined remote
contact (changeover
contact) optionally
available

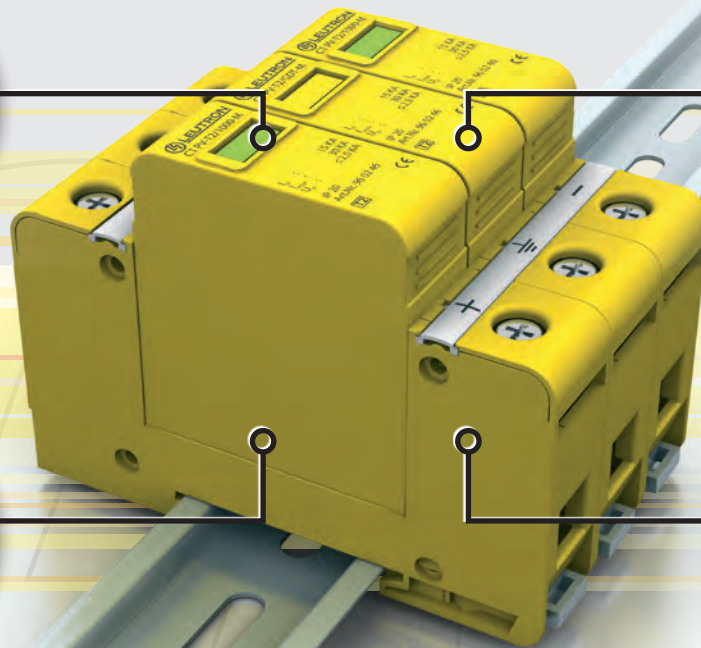



3 PHASE POWER SUPPLY SYSTEMS

1 PHASE POWER SUPPLY SYSTEMS

Network Type

Description

Adequate SPD circuit Type
Basic circuit diagram

TN-S

3 phase power supply systems
separated N and PE

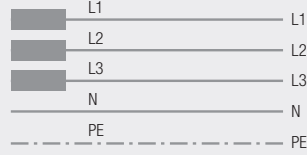

4 + 0-circuits

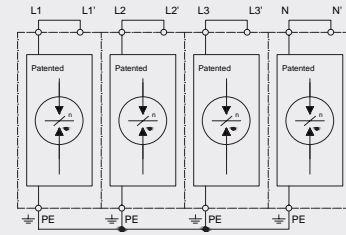

TT/ TN-S

3 phase power supply systems
separated N and PE

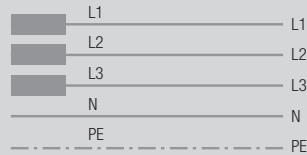

3 + 1-circuits

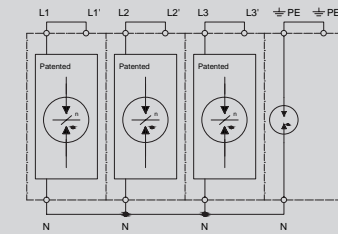

TN-C

3 phase power supply systems
common PEN



3 + 0-circuits

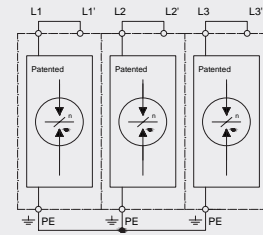

TT/ TN-S

1 phase power supply systems
separated N and PE



1 + 1-circuits

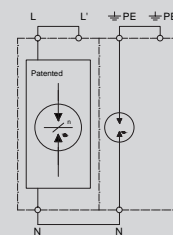

TN

1 phase power supply systems
L/N to PE



1 + 0-circuits

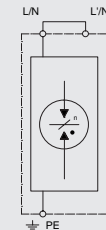



**Lightning current arrester Type 1,
PowerPro B at the LPZ transition
point $O_A - 1^*$**

**Combined arrester Type 1+2 (V wiring)
PowerPro BC at the LPZ transition
point $O_A - 2^*$**

**Combined arrester Type 1+2+3
PowerPro BCD at the LPZ transition
point $O_A - 2^*$**

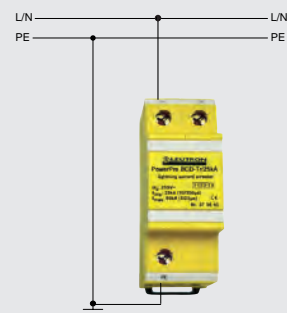
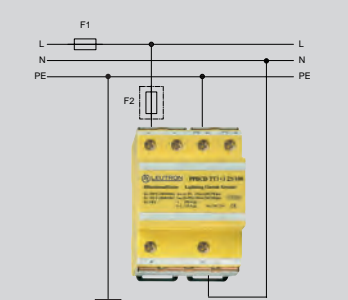
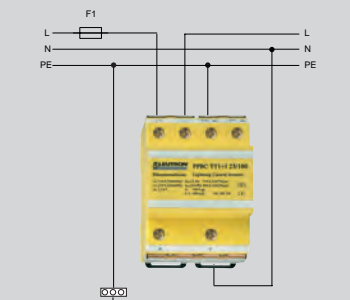
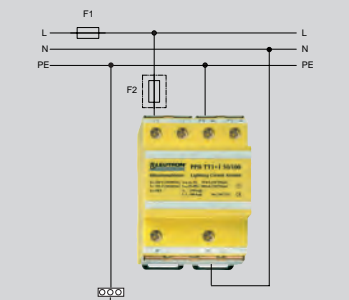
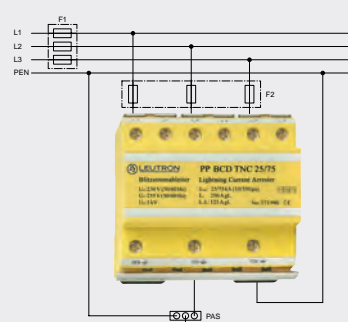
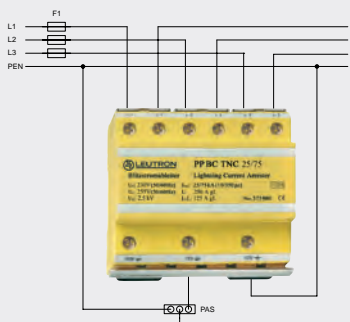
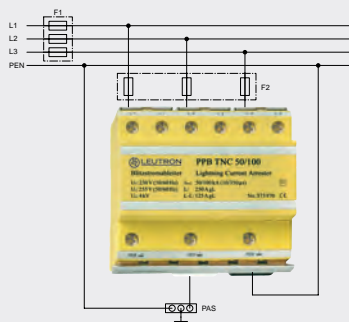
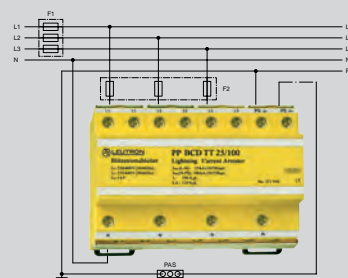
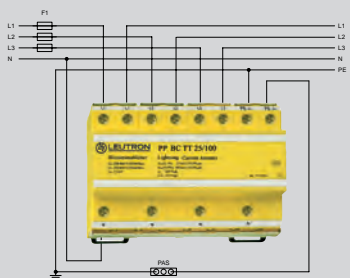
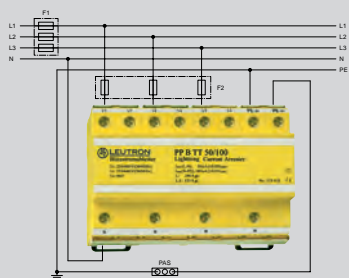
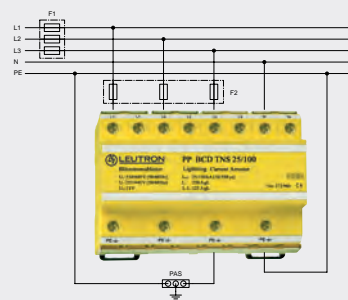
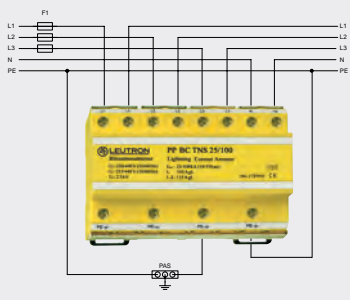
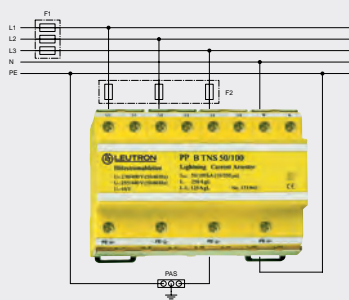

* according to the lightning protection zones concept



3 PHASE POWER SUPPLY SYSTEMS

1 PHASE POWER SUPPLY SYSTEMS

Network Type

Description

Adequate SPD circuit Type

TN-S

3 phase power supply systems
separated N and PE

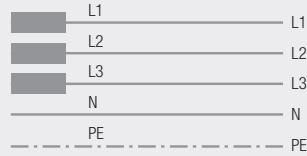

4 + 0-circuits

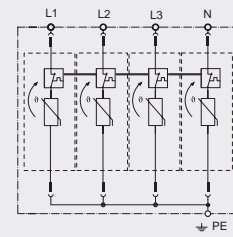

TT/ TN-S

3 phase power supply systems
separated N and PE

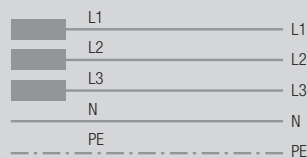

3 + 1-circuits

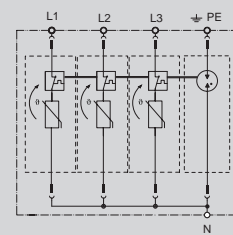

TN-C

3 phase power supply systems
common PEN



3 + 0-circuits

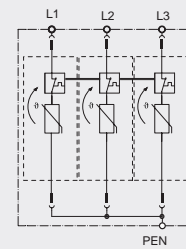

TT/
TN-S

1 phase power supply systems
separated N and PE



1 + 1-circuits

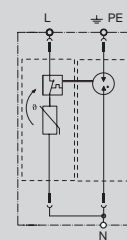

TN

1 phase power supply systems
L/N to PE



1 + 0-circuits

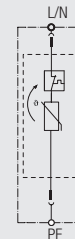



SPD Type 2 (class II), Spur wiring at the LPZ transition point Ob-1*

SPD Type 2 (class II), V wiring at the LPZ transition point Ob-1*

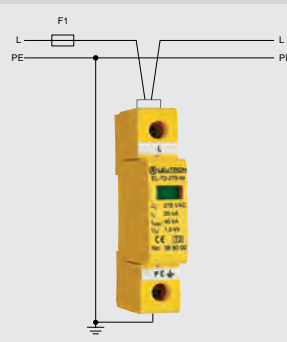
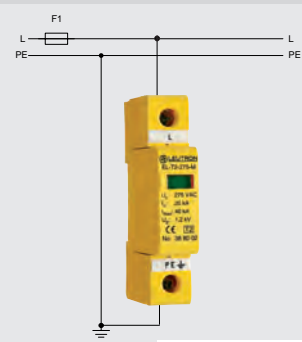
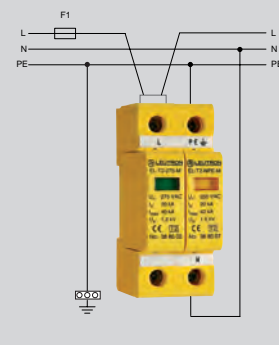
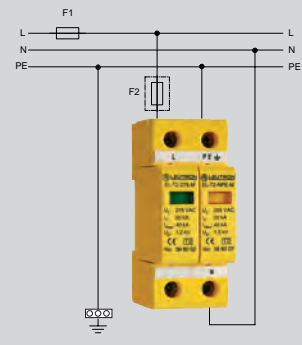
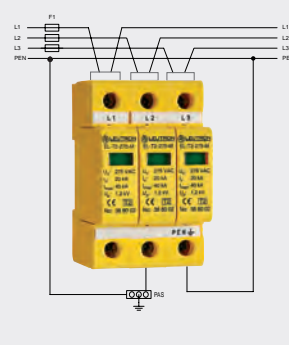
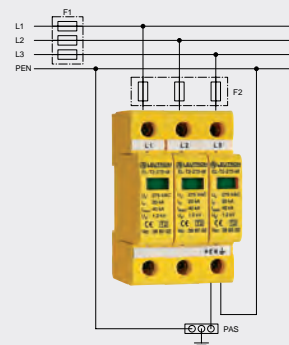
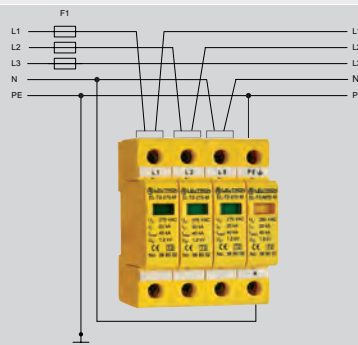
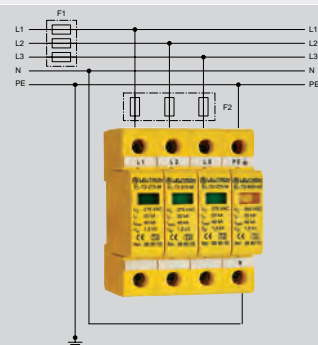
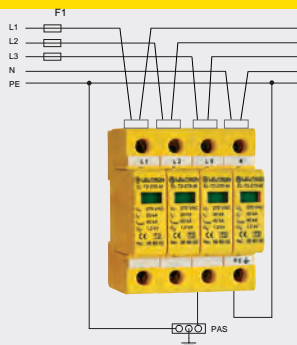
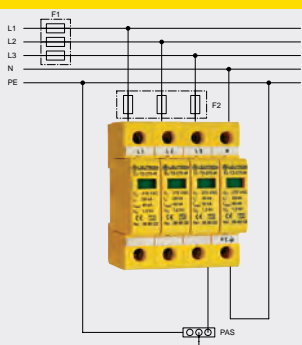

* according to the lightning protection zones concept



Lightning current arrester Type 1 for AC power supplies / CT Series

CT-T1

Lightning current discharge arrester (class I) with rare-gas-filled spark gap. They provide extremely high discharge capabilities with at the same time very low protection levels and they also do not need any damageable internal or external electronic trigger.

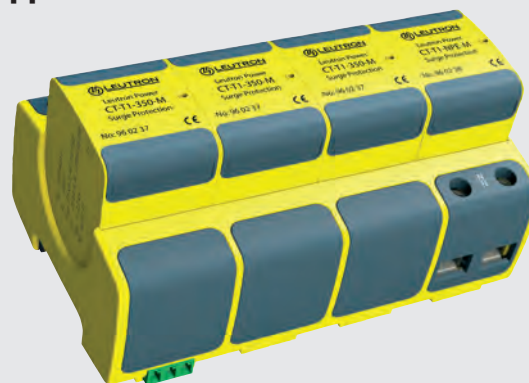



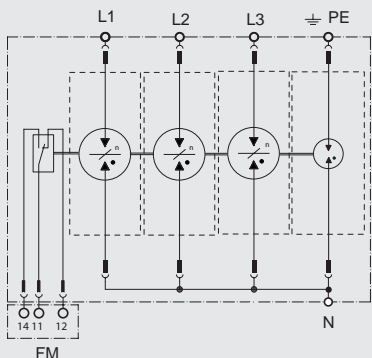

Example photo

Basic circuit diagram





- Applicable at the boundaries LPZ OA - 1
- Test standard: IEC 61643-1 / EN 61643-11
- Vibration and Shock according standard: DIN EN 60068-2-6 and DIN EN 60068-2-27
- Available for all net systems
- Enclosure material: thermoplastic with the colors yellow and black
- Mounting on 35 mm DIN rail
- Degree of protection according to IEC EN 60529: IP 20
- Inflammability class according to UL 94 V0
- Remote changeover contact
- No leakage currents, thus, allowing installation upstream of power meters

				
Technical Data	CT-T1/3+1-350-FM	CT-T1/3+0-350-FM	CT-T1/2+0-350-FM	CT-T1/1+1-350-FM
Article-No.	96 02 07	96 02 09	96 02 13	96 02 15
EC category/EN type	Type 1 / class I	Type 1 / class I	Type 1 / class I	Type 1 / class I
Nominal voltage	UN 230/400 V	230/400 V	230/400 V	230/400 V
Max. continuous operating voltage AC	Uc 350 V~	350 V~	350 V~	350 V~
Lightning impulse current (10/350) total	Itotal 100 kA	75 kA	50 kA	50 kA
Lightning impulse current (10/350) L-N/N-PE/L-PEN	Iimp 25 / 100 / - kA	- / - / 75 (3L-PEN) kA	25 / - / - kA	25 / 50 / - kA
Nominal discharge current (8/20) L-N/N-PE/L-PEN	In 25 / 100 / - kA	- / - / 75 (3L-PEN) kA	25 / - / - kA	25 / 50 / - kA
Voltage protection level at Iimp	Up ≤ 2,5 kV	≤ 2,5 kV	≤ 2,5 kV	≤ 2,5 kV
Follow current quenching capacity AC L-N (260V AC)	Ifi 10 kAeff	10 kAeff	10 kAeff	10 kAeff
Short-circuit withstand capability at max. back-up fuse	Ikc 50 kAeff	50 kAeff	50 kAeff	50 kAeff
Max. acceptable backup fuse (branch wiring)	250 A gL/gG	250 A gL/gG	250 A gL/gG	250 A gL/gG
Max. acceptable backup fuse (V-type through wiring)	125 A gL/gG	125 A gL/gG	125 A gL/gG	125 A gL/gG
Operating temperature range	TU -40 - +80 °C	-40 - +80 °C	-40 - +80 °C	-40 - +80 °C
Min. conductor cross section at terminals	10mm ² solid/flexible	10mm ² solid/flexible	10mm ² solid/flexible	10mm ² solid/flexible
Max. conductor cross section	50mm ² stranded/35mm ² flexible	50mm ² stranded/35mm ² flexible	50mm ² stranded/35mm ² flexible	50mm ² stranded/35mm ² flexible
Dimension (DIN 43880)	147,2 mm	113,5 mm	76,5 mm	76,5 mm
Max. operating voltage remote contact	250 V AC/125 V DC	250 V AC/125 V DC	250 V AC/125 V DC	250 V AC/125 V DC
Max. operating current remote contact	1 A AC/200 mA DC	1 A AC/200 mA DC	1 A AC/200 mA DC	1 A AC/200 mA DC
Composed of: number of moduls	3x 96 02 37 + 1x 96 02 38	3x 96 02 37	2x 96 02 37	1x 96 02 37 + 1x 96 02 38
Power supply system	3 phase TNS and TT systems	3 phase TNC systems	1 phase TN systems	1 phase TT and TNS systems

Dimension drawing, see pages 194 to 198



		
Technical Data	CT-T1/1+0-350-FM	CT-T1/0+1-FS-FM
Article-No.	96 02 17	96 02 33
EC category/EN type	Type 1 / class I	Type 1 / class I
Nominal voltage	UN 230/400 V	230 V
Max. continuous operating voltage AC	Uc 350 V~	260 V~
Lightning impulse current (10/350) total	I _{total} 25 kA	100 kA
Lightning impulse current (10/350) L-N/N-PE/L-PEN	I _{imp} 25 / - / - kA	- / 100 / - kA
Nominal discharge current (8/20) L-N/N-PE/L-PEN	I _n 25 / - / 25 kA	- / 100 / - kA
Voltage protection level at I _{imp}	U _p ≤ 2,5 kV	≤ 2,5 kV
Follow current quenching capacity AC L-N (260V AC)	I _{fi} 10 kAeff	100 Aeff
Short-circuit withstand capability at max. back-up fuse	I _k 50 kAeff	50 kAeff
Max. acceptable backup fuse (branch wiring)	250 A gL/gG	250 A gL/gG
Max. acceptable backup fuse (V-type through wiring)	125 A gL/gG	125 A gL/gG
Operating temperature range	TU -40 - +80 °C	-40 - +80 °C
Min. conductor cross section at terminals	10mm ² solid/flexible	10mm ² solid/flexible
Max. conductor cross section	50mm ² stranded/35mm ² flexible	50mm ² stranded/35mm ² flexible
Dimension (DIN 43880)	39,8 mm	39,8 mm
Max. operating voltage remote contact	250 V AC/125 V DC	250 V AC/125 V DC
Max. operating voltage remote contact	1 A AC/200 mA DC	1 A AC/200 mA DC
Composed of: number of moduls	1x 96 02 37	1x 96 02 378
Power supply system	between L und N	between N und PE

Accessories: Module		
	CT-T1-350-M	CT-T1-NPE-M
Article-No.	96 02 37	96 02 38



Replacement protective plug for lightning current discharge arresters.



Lightning current arrester Type 1 for AC power supplies / PowerPro



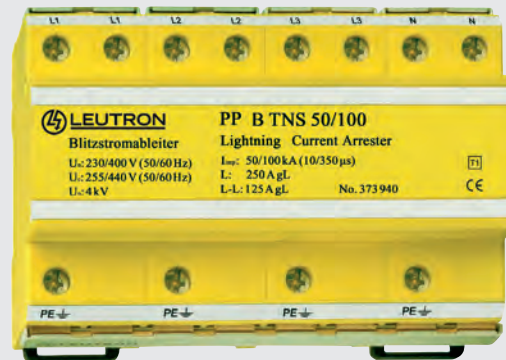
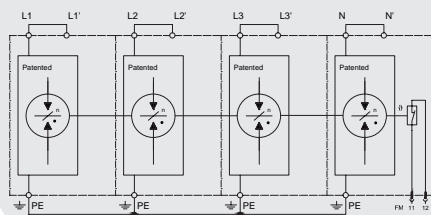

PowerPro B

Multi-pole lightning current arrester Type 1 (class I). The arresters can be installed at the transition OA to 1 according to the lightning protection zones concept. The SPDs of the series PowerPro B feature a high thermal resistance and an outstanding discharge capability for lightning impulse currents of 50 kA (10/350 μs) per pole. Therefore, they can be applied according to DIN EN 62305 (VDE 0185-305).

Basic circuit diagram







- Test standard: IEC 61643-1 / EN 61643-11
- Vibration and Shock according standard: DIN EN 60068-2-6 and DIN EN 60068-2-27
- Operates independently of atmospheric air pressure and ambient humidity
- Optional remote signalling contact (FM)
- NEW: only one remote signalling contact (FM) (internal wire connection)
- Remote signalling contact: break contact
- High quenching of follow-on short-circuit currents
- High TOV resistance
- High insulation resistance
- Degree of protection according to IEC EN 60529: IP 20
- Mounting on 35 mm DIN rail





				
Technical Data	PP B TNS 50/100	PP B TNS 50/100-350	PP B TNS 440	PP B TNC 50/100
Article-No.	37 39 40	37 41 20	37 39 43	37 39 70
Nominal voltage AC	UN 230/400 V~	230/400 V~	400/690 V~	230/400 V~
Max. continuous operating voltage AC	Uc 255 V~	350 V~	440 V~	255 V~
Insulation resistance	Risol >10 GΩ	>10 GΩ	>10 GΩ	>10 GΩ
Protection level at 100% lightning imp. sparkover voltage (1.2/50μs)	Up ≤ 4,0 kV	≤ 4,0 kV	≤ 4,0 kV	≤ 4,0 kV
Voltage protection level at limp [L-PE]	Up ≤ 4,0 kV	≤ 4,0 kV	≤ 4,0 kV	≤ 4,0 kV
Response time	<50 ns	<50 ns	<50 ns	<50 ns
Lightning impulse current (10/350) [L1+L2+L3+N-PE] Itotal	100 kA	100 kA	100 kA	75 kA
Lightning impulse current (10/350μs) (L,N-PE) Iimp	50 kA	50 kA	25 kA	25 kA
Follow-on current extinguishing capability at Uc (50/60 Hz) Ifi	4 kA	4 kA	0,75 kA	4 kA
Short-circuit withstand capability at max. back-up fuse Ik	50 kAeff	50 kAeff	50 kAeff	50 kAeff
Max. acceptable backup fuse (branch wiring)	250 A gL/gG	250 A gL/gG	63 A gL/gG	250 A gL/gG
Max. acceptable backup fuse F1 (V wiring)	125 A gL/gG	125 A gL/gG	63 A gL/gG	125 A gL/gG
Operating temperature range	TU -40 - +80 °C	-40 - +80 °C	-40 - +80 °C	-40 - +80 °C
Max. conductor cross section	50mm ² stranded/35mm ² flexible	50mm ² stranded/35mm ² flexible	50mm ² stranded/35mm ² flexible	50mm ² stranded/35mm ² flexible
Recommended conductor cross section	25 mm ²	25 mm ²	25 mm ²	25 mm ²
Max. connection torque for terminals	4,5 Nm	4,5 Nm	4,5 Nm	4,5 Nm
Enclosure material / colour	polycarbonate (halogen-free) UL 94-V0 / yellow			

With remote signalling contact (FM)	PP B TNS 50/100/FM	PP B TNS 50/100/FM-350	PP B TNS 440/FM	PP B TNC 50/100 /FM
Article-No.	37 39 42	37 41 25	37 39 44	37 39 72
Switching capacity	250 V/2 A	250 V/2 A	250 V/2 A	250 V/2 A
Max. conductor cross section FM	1,5 mm ²	1,5 mm ²	1,5 mm ²	1,5 mm ²





				
Technical Data	PP B TNC 50/100-350	PP B TNC 440	PP B TN 50/100	PP B TN 440
Article-No.	37 41 10	37 39 64	38 12 10	37 39 45
Nominal voltage AC	UN 230/400 V~	400/690 V~	230/400 V~	400 V~
Max. continuous operating voltage AC	Uc 350 V~	440 V~	255 V~	440 V~
Insulation resistance	Risol >10 GΩ	>10 GΩ	>10 GΩ	>10 GΩ
Protection level at 100% lightning imp. sparkover voltage (1.2/50μs)	Up ≤ 4,0 kV	≤ 4,0 kV	≤ 4,0 kV	≤ 4,0 kV
Voltage protection level at limp [L-PEN]	Up ≤ 4,0 kV	≤ 4,0 kV	≤ 4,0 kV	≤ 4,0 kV
Response time	tA <50 ns	<50 ns	<50 ns	< 50 ns
Lightning impulse current (10/350μs) [L1+L2+L3-PEN] Itotal	75 kA	75 kA	100 kA	50 kA
Lightning impulse current (10/350μs) [L-PEN] Iimp	25 kA	25 kA	50 kA	25 kA
Follow-on current extinguishing capability at Uc (50/60 Hz) Ifi	4 kA	4 kA	4 kA	4 kA
Short-circuit withstand capability at max. back-up fuse Ik	50 kAeff	50 kAeff	50 kAeff	50 kAeff
Max. acceptable backup fuse (branch wiring)	250 A gL/gG	63 A gL/gG	250 A gL/gG	63 A gL/gG
Max. acceptable backup fuse F1 (V wiring)	125 A gL/gG	63 A gL/gG	125 A gL/gG	63 A gL/gG
Operating temperature range	TU -40 - +80 °C	-40 - +80 °C	-40 - +80 °C	-40 - +80 °C
Max. conductor cross section	50mm ² stranded/35mm ² flexible	50mm ² stranded/35mm ² flexible	50mm ² stranded/35mm ² flexible	50mm ² stranded/35mm ² flexible
Recommended conductor cross section	25 mm ²	25 mm ²	25 mm ²	25 mm ²
Max. connection torque for terminals	4,5 Nm	4,5 Nm	4,5 Nm	4,5 Nm
Enclosure material / colour	polycarbonate (halogen-free) UL 94-V0 / yellow			

With remote signalling contact (FM)	PP B TNC 50/100/FM-350	PP B TNC 440/FM	PP B TN 50/100/FM	PP B TN 440/FM
Article-No.	37 41 15	37 39 65	38 12 11	37 39 46
Switching capacity	250 V/2 A	250 V/2 A	250 V/2 A	250 V/2 A
Max. conductor cross section FM	1,5 mm ²	1,5 mm ²	1,5 mm ²	1,5 mm ²

				
Technical Data	PP B TT 50/100	PP B TT 50/100-350	PP B TT1+1 50/100	PP B TT2+1 50/100
Article-No.	37 39 10	37 41 30	38 11 30	37 39 15
Nominal voltage AC	UN 230/400 V~	230/400 V~	230/400 V~	100/200 bzw. 110/220 V~
Max. continuous operating voltage AC	Uc 255 V~	350 V~	255 V~	>255 V~
Insulation resistance	Risol >10 GΩ	>10 GΩ	>10 GΩ	>10 GΩ
Protection level at 100% lightning imp. sparkover voltage (1.2/50μs)	Up ≤ 4,0 kV	≤ 4,0 kV	≤ 4,0 kV	<4,0 kV
Voltage protection level at limp [L-N]	Up ≤ 4,0 kV	≤ 4,0 kV	≤ 4,0 kV	<4,0 kV
Response time	tA <50 ns	<50 ns	<50 ns	<50 ns
Lightning impulse current (10/350) [L1+L2+L3+N-PE] Itotal	100 kA	100 kA	100 kA	100 kA
Lightning impulse current (10/350μs) [L-N] Iimp	50 kA	50 kA	50 kA	50 kA
Lightning impulse current (10/350μs) [N-PE] Iimp	100 kA	100 kA	100 kA	100 kA
Follow-on current extinguishing capability at Uc (50/60 Hz) Ifi	4 kA	4 kA	4 kA	4 kA
Short-circuit withstand capability at max. back-up fuse Ik	50 kAeff	50 kAeff	50 kAeff	50 kAeff
Max. acceptable backup fuse (branch wiring)	250 A gL/gG	250 A gL/gG	250 A gL/gG	250 A gL/gG
Max. acceptable back-up fuse F1 (V wiring)	125 A gL/gG	125 A gL/gG	125 A gL/gG	125 A gL/gG
Operating temperature range	TU -40 - +80 °C	-40 - +80 °C	-40 - +80 °C	-40 - +80 °C
Max. conductor cross section	50mm ² stranded/35mm ² flexible	50mm ² stranded/35mm ² flexible	50mm ² stranded/35mm ² flexible	50mm ² stranded/35mm ² flexible
Recommended conductor cross section	25 mm ²	25 mm ²	25 mm ²	25 mm ²
Max. connection torque for terminals	4,5 Nm	4,5 Nm	4,5 Nm	4,5 Nm

With remote signalling contact (FM)	PP B TT 50/100/FM	PP B TT 50/100/FM-350	PP B TT1+1 50/100 /FM	PP B TT2+1 50/100 /FM
Article-No.	37 39 12	37 41 35	38 11 31	37 39 17
Switching capacity	250 V/2 A	250 V/2 A	250 V/2 A	250 V/2 A
Max. conductor cross section FM	1,5 mm ²	1,5 mm ²	1,5 mm ²	1,5 mm ²



			
Technical Data		PP B IT 50/100	PowerPro-B-Tr/50kA
Article-No.		37 39 18	N. A.
Nominal voltage AC	UN	230/400 V~	230/400 V~
Max. continuous operating voltage AC	Uc	>440 V~	255 V~
Insulation resistance	Risol	>10 GΩ	>10 GΩ
Protection level at 100% lightning imp. sparkover voltage (1.2/50μs)	Up	≤ 4,0 kV	≤ 4,0 kV
Voltage protection level at limp L-N	Up	≤ 4,0 kV	≤ 4,0 kV
Response time	tA	<50 ns	< 50 ns
Lightning impulse current (10/350) L1+L2+L3+N-PE	Itotal	100 kA	50 kA
Lightning impulse current (10/350) L-N	limp	50 kA	-
Lightning impulse current (10/350) N-PE	limp	k. A.	-
Follow-on current extinguishing capability at Uc (50/60 Hz) Ifi		4 kA	4 kA
Short-circuit withstand capability at max. back-up fuse	Ik	50 kAeff	-
Max. acceptable back-up fuse F2 (spur wiring)		63 A gL/gG	250 A gL/gG
Max. acceptable back-up fuse F1 (V wiring)		63 A gL/gG	125 A gL/gG
Operating temperature range	TU	-40 - +80 °C	-40 - +80 °C
Max. conductor cross section		50mm ² stranded/35mm ² flexible	50mm ² stranded/35mm ² flexible
Recommended conductor cross section		min. 25 mm ²	min. 25 mm ²
Max. connection torque for terminals		4,5 Nm	4,5 Nm

With remote signalling contact (FM)		PP B IT 50/100/FM	PowerPro-B-Tr/50kA/Pk
Article-No.		37 39 19	37 38 40
Switching capacity		250 V/2 A	250 V/2 A
Max. conductor cross section FM		1,5 mm ²	1,5 mm ²

Lightning current arrester Type 1 for AC power supplies / Wind Energy Converter

PowerPro B 25-760

Lightning current arrester (class I) for wind energy applications for lightning protection equipotential bonding in 690 V IT systems.

- New developed ceramic isolating spark gap
- Optional remote signalling contact (FM)

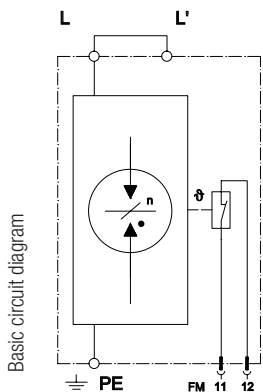

			
			without fig.
Technical Data		PP B 25-760	PP B 25-760/FM
Article-No.		37 45 20	37 45 21
Nominal voltage AC	UN	690 V~	690 V~
Max. continuous operating voltage AC	Uc	760 V~	760 V~
Insulation resistance	Risol	> 10 GΩ	> 10 GΩ
Protection level	Up	4,0 kV	4,0 kV
Response time	tA	100 ns	100 ns
Lightning impulse current limp (10/350 μs)	lpeak	25 kA	25 kA
Max. acceptable back-up fuse F2 (spur wiring)		250 A gL/gG	250 A gL/gG
Operating temperature range	TU	-40 - +80 °C	-40 - +80 °C
Max. connection torque for terminals		4,5 Nm	4,5 Nm
Max. conductor cross section		50mm ² stranded/35mm ² flexible	
Degree of protection (IEC EN 60529)		IP 20	IP 20
Enclosure material / colour		polyamide PA 6 30SV, UL94 V0 / yellow	
Mounting on		35 mm DIN rail form C (EN 50 022)	
Net weight / pc		ca. 300 g	ca. 320 g
FM contact / contact Type		-	break contact
Switching capacity		-	250 V/2 A

Dimension drawing, see pages 194 to 198



Lightning current arrester Type 1 for AC power supplies / IsoPro

IsoPro B



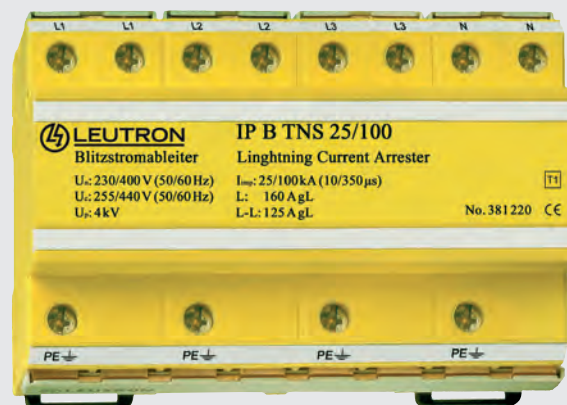

Multi-pole lightning current arrester (class I) for the protection of low-voltage consumers' installations in business and residential areas against surges caused by lightning or switching actions in the network.

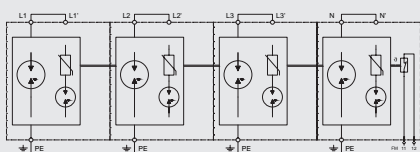

Basic circuit diagram



- Rare-gas-filled spark gap, hermetically sealed
- No leakage currents, thus, allowing installation upstream of power meters
- Vibration and Shock according standard: DIN EN 60068-2-6 and DIN EN 60068-2-27
- High TOV resistance
- Operates independently of atmospheric air pressure and ambient humidity
- High insulation resistance
- NEW: only one remote signalling contact (FM)

				
Technical Data	IP B TNS 25/100	IP B TNS 60/100	IP B TNC 25/75	IP B TNC 60/100
Article-No.	38 12 20	38 11 45	38 12 16	38 11 40
Nominal voltage AC	UN 230/400 V~	230/400 V~	230/400 V~	230/400 V~
Max. continuous operating voltage AC	Uc 255 V~	255 V~	255 V~	255 V~
Insulation resistance	Risol >10 GΩ	>10 GΩ	>10 GΩ	> 10 GΩ
Protection level at 100% lightning imp. sparkover voltage (1.2/50µs)	Up ≤ 4,0 kV	≤ 4,0 kV	≤ 4,0 kV	≤ 4,0 kV
Voltage protection level at limp L-PE	Up ≤ 4,0 kV	≤ 4,0 kV	≤ 4,0 kV	≤ 4,0 kV
Response time	tA <50 ns	<50 ns	<50 ns	<50 ns
Lightning impulse current (10/350) L1+L2+L3+N-PE	Itotal 100 kA	100 kA	75 kA	100 kA
Lightning impulse current (10/350) L,N-PE	limp 25 kA	60 kA	25 kA	60 kA
Short-circuit withstand capability at max. back-up fuse	Ik 50 kAeff	50 kAeff	50 kAeff	50 kAeff
Max. acceptable back-up fuse F2 (spur wiring)	160 A gL/gG	160 A gL/gG	160 A gL/gG	160 A gL/gG
Max. acceptable back-up fuse F1 (V wiring)	125 A gL/gG	125 A gL/gG	125 A gL/gG	125 A gL/gG
Operating temperature range	TU -40 - +80 °C	-40 - +80 °C	-40 - +80 °C	-40 - +80 °C
Max. conductor cross section	50mm² stranded/35mm² flexible	50mm² stranded/35mm² flexible	50mm² stranded/35mm² flexible	50mm² stranded/35mm² flexible
Recommended conductor cross section	25 mm²	25 mm²	25 mm²	25 mm²
Max. connection torque for terminals	4,5 Nm	4,5 Nm	4,5 Nm	4,5 Nm
Enclosure material / colour	polycarbonate (halogen-free) UL 94-V0 / yellow			





With remote signalling contact (FM)	IP B TNS 25/100/FM	IP B TNS 60/100/FM	IP B TNC 25/75/FM	IP B TNC 60/100 /FM
Article-No.	38 12 21	38 11 46	38 12 17	38 11 41
Switching capacity	250 V/2 A	250 V/2 A	250 V/2 A	250 V/2 A
Max. conductor cross section FM	1,5 mm²	1,5 mm²	1,5 mm²	1,5 mm²

Dimension drawing, see pages 194 to 198





SURGE PROTECTION FOR POWER SUPPLY SYSTEMS

AC POWER SUPPLY

					
Technical Data		IP B TT 25/100	IP B TT 60/100	IP B TT1+1 25/50	IP B TT1+1 60/100
Article-No.		38 12 24	38 11 50	38 12 28	38 11 55
Nominal voltage AC	UN	230/400 V~	230/400 V~	230/400 V~	230/400 V~
Max. continuous operating voltage AC	Uc	255 V~	255 V~	255 V~	255 V~
Insulation resistance	Risol	>10 GΩ	>10 GΩ	>10 GΩ	>10 GΩ
Protection level at 100% lightn. imp. sparkover voltage (1.2/50µs)	Up	≤ 4,0 kV	≤ 4,0 kV	≤ 4,0 kV	≤ 4,0 kV
Voltage protection level at limp L-N	Up	≤ 4,0 kV	≤ 4,0 kV	≤ 4,0 kV	≤ 4,0 kV
Response time	tA	<50 ns	<50 ns	<50 ns	<50 ns
Lightning impulse current (10/350) L1+L2+L3+N-PE	Itotal	100 kA	100 kA	50 kA	100 kA
Lightning impulse current (10/350) L-N	limp	25 kA	60 kA	25 kA	60 kA
Lightning impulse current (10/350) N-PE	limp	100 kA	100 kA	50 kA	100 kA
Short-circuit withstand capability at max. back-up fuse	Ik	50 kAeff	50 kAeff	50 kAeff	50 kAeff
Max. acceptable back-up fuse F2 (spur wiring)		160 A gL/gG	160 A gL/gG	160 A gL/gG	160 A gL/gG
Max. acceptable back-up fuse F1 (V wiring)		125 A gL/gG	125 A gL/gG	125 A gL/gG	125 A gL/gG
Operating temperature range	TU	-40 - +80 °C	-40 - +80 °C	-40 - +80 °C	-40 - +80 °C
Max. conductor cross section		50mm ² stranded/35mm ² flexible	50mm ² stranded/35mm ² flexible	50mm ² stranded/35mm ² flexible	50mm ² stranded/35mm ² flexible
Recommended conductor cross section		25 mm ²	25 mm ²	25 mm ²	25 mm ²
Max. connection torque for terminals		4,5 Nm	4,5 Nm	4,5 Nm	4,5 Nm
Enclosure material / colour		polycarbonate (halogen-free) UL 94-V0 / yellow			

With remote signalling contact (FM)	IP B TT 25/100/FM	IP B TT 60/100/FM	IP B TT1+1 25/50/FM	IP B TT1+1 60/100 /FM
Article-No.	38 12 25	38 11 51	38 12 29	38 11 56
Switching capacity	250 V/2 A	250 V/2 A	250 V/2 A	250 V/2 A
Max. conductor cross section FM	1,5 mm ²	1,5 mm ²	1,5 mm ²	1,5 mm ²

			
Technical Data		IP B TN 25/50	IP B TN 60/100
Article-No.		38 12 36	38 12 32
Nominal voltage AC	UN	230/400 V~	230/400 V~
Max. continuous operating voltage AC	Uc	255 V~	255 V~
Insulation resistance	Risol	>10 GΩ	>10 GΩ
Protection level at 100% lightn. imp. sparkover voltage (1.2/50µs)	Up	≤ 4,0 kV	≤ 4,0 kV
Voltage protection level at limp L-PE	Up	≤ 4,0 kV	≤ 4,0 kV
Response time	tA	< 50 ns	< 50 ns
Lightning impulse current (10/350) L+N-PE	Itotal	50 kA	100 kA
Lightning impulse current (10/350) L,N-PE	limp	25 kA	60 kA
Short-circuit withstand capability at max. back-up fuse	Ik	50 kAeff	50 kAeff
Max. acceptable back-up fuse F2 (spur wiring)		160 A gL/gG	160 A gL/gG
Max. acceptable back-up fuse F1 (V wiring)		125 A gL/gG	125 A gL/gG
Operating temperature range	TU	-40 - +80 °C	-40 - +80 °C
Max. conductor cross section		50mm ² stranded/35mm ² flexible	50mm ² stranded/35mm ² flexible
Recommended conductor cross section		25 mm ²	25 mm ²
Max. connection torque for terminals		4,5 Nm	4,5 Nm
Enclosure material / colour		polycarbonate (halogen-free) UL 94-V0 / yellow	

With remote signalling contact (FM)	IP B TN 25/50/FM	IP B TN 60/100/FM
Article-No.	38 12 37	38 12 33
Switching capacity	250 V/2 A	250 V/2 A
Max. conductor cross section FM	1,5 mm ²	1,5 mm ²

Dimension drawing, see pages 194 to 198



Combined arrester Type 1 + 2 for AC power supplies / CT series

CT-T1+2





Lightning current discharge arrester (class I+II) with rare-gas-filled spark gap for one and three phase systems and very low protection level < 1.5 kV. They provide extremely high discharge capabilities with at the same time very low protection levels and they also do not need any damageable internal or external electronic trigger.

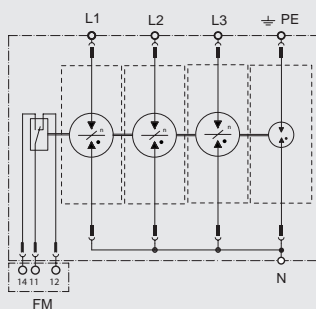

Basic circuit diagram



- Applicable at the boundaries LPZ OA - 2
- Test standard: IEC 61643-1 / EN 61643-11
- Vibration and Shock according standard: DIN EN 60068-2-6 and DIN EN 60068-2-27
- Mounting on 35 mm DIN rail
- Enclosure material: thermoplastic with the colors yellow and black
- Degree of protection according to IEC EN 60529: IP 20
- Inflammability class according to UL 94 V0
- Remote changeover contact
- No leakage currents, thus, allowing installation upstream of power meters
- Available for all net systems



				
Technical Data	CT-T1+2/3+1-350-FM	CT-T1+2/3+0-350-FM	CT-T1+2/2+0-350-FM	CT-T1+2/1+1-350-FM
Article-No.	96 00 01	96 00 03	96 00 07	96 00 09
EC category/EN type	Type 1+2/class I+II	Type 1+2/class I+II	Type 1+2/class I+II	Type 1+2/class I+II
Nominal voltage	UN 230/400 V	230/400 V	230/400 V	230/400 V
Max. continuous operating voltage AC	Uc 350 V~	350 V~	350 V~	350 V~
Lightning impulse current (10/350) total	I _{total} 100 kA	75 kA	50 kA	50 kA
Lightning impulse current (10/350) L-N/N-PE/L-PEN	I _{limp} 25 / 100 / - kA	- / - / 75 (3L-PEN) kA	25 / - / - kA	25 / 50 / - kA
Nominal discharge current (8/20) L-N/N-PE/L-PEN	I _n 25 / 100 / - kA	- / - / 75 (3L-PEN) kA	25 / - / - kA	25 / 50 / - kA
Voltage protection level at I _{limp}	U _p ≤ 1,5 kV	≤ 1,5 kV	≤ 1,5 kV	≤ 1,5 kV
Follow current quenching capacity AC L-N (260V AC)	I _{fi} 4 kA _{eff}	4 kA _{eff}	4 kA _{eff}	4 kA _{eff}
Follow current quenching capacity AC N-PE	I _{fi} 100 A _{eff}	50 kA _{eff}	50 kA _{eff}	100 A _{eff}
Short-circuit withstand capability at max. back-up fuse	I _k 50 kA _{eff}	k. A.	k. A.	50 kA _{eff}
Max. acceptable backup fuse (branch wiring)	250 A gL/gG	250 A gL/gG	250 A gL/gG	250 A gL/gG
Max. acceptable backup fuse (V-type through wiring)	125 A gL/gG	125 A gL/gG	125 A gL/gG	125 A gL/gG
Operating temperature range	TU -40 - +80 °C	-40 - +80 °C	-40 - +80 °C	-40 - +80 °C
Min. conductor cross section at terminals	10mm ² solid/flexible	10mm ² solid/flexible	10mm ² solid/flexible	10mm ² solid/flexible
Max. conductor cross section	50mm ² stranded/35mm ² flexible	50mm ² stranded/35mm ² flexible	50mm ² stranded/35mm ² flexible	50mm ² stranded/35mm ² flexible
Dimension (DIN 43880)	147,2 mm	113,5 mm	76,5 mm	76,5 mm
Max. operating voltage remote contact	1 A AC/200 mA DC	1 A AC/200 mA DC	1 A AC/200 mA DC	1 A AC/200 mA DC
Max. operating voltage remote contact	250 V AC/125 V DC	250 V AC/125 V DC	250 V AC/125 V DC	250 V AC/125 V DC
Composed of: number of moduls	3x 96 02 36 + 1x 96 02 38	3x 96 02 36	2x 96 02 36	1x 96 02 36 + 1x 96 02 38
Power supply system	3 phase TNS and TT systemse	3 phase TNC systemse	1 phase TN systemse	1 phase TT and TNS systems

Dimension drawing, see pages 194 to 198



SURGE PROTECTION FOR POWER SUPPLY SYSTEMS

AC POWER SUPPLY

		
Technical Data	CT-T1+2/1+0-350-FM	CT-T1/0+1-FS-FM
Article-No.	96 00 11	96 02 33
EC category/EN type	Type 1+2/class I+II	Type 1 / class I
Nominal voltage	UN 230/400 V	230 V
Max. continuous operating voltage AC	Uc 350 V~	260 V~
Lightning impulse current (10/350) total	Itotal 25 kA	100 kA
Lightning impulse current (10/350) L-N/N-PE/L-PEN	Iimp 25 / - / - kA	- / 100 / - kA
Nominal discharge current (8/20) L-N/N-PE/L-PEN	In 25 / - / 25 kA	- / 100 / - kA
Voltage protection level at Iimp	Up ≤ 1,5 kV	≤ 2,5 kV
Follow current quenching capacity AC L-N (260V AC)	Ifi 4 kAeff	100 Aeff
Short-circuit withstand capability at max. back-up fuse	Ikc 50 kAeff	50 kAeff
Max. acceptable backup fuse (branch wiring)	250 A gL/gG	250 A gL/gG
Max. acceptable backup fuse (V-type through wiring)	125 A gL/gG	125 A gL/gG
Operating temperature range	TU -40 - +80 °C	-40 - +80 °C
Min. conductor cross section at terminals	10mm ² solid/flexible	10mm ² solid/flexible
Max. conductor cross section	50mm ² stranded/35mm ² flexible	50mm ² stranded/35mm ² flexible
Dimension (DIN 43880)	39,8 mm	39,8 mm
Max. operating voltage remote contact	250 V AC/125 V DC	250 V AC/125 V DC
Max. operating voltage remote contact	1 A AC/200 mA DC	1 A AC/200 mA DC
Composed of: number of moduls	1x 96 02 36	1x 96 02 378
Power supply system	between L and N	between N and PE

Accessories		
	CT-T1+2-350-M	CT-T1-NPE-M
Article-No.	96 02 36	96 02 38



Replacement protective plug for combined lightning current discharge and surge arresters.

Dimension drawing, see pages 194 to 198





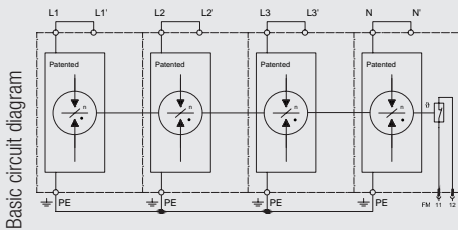

Combined arrester Type 1 + 2 for AC power supplies / PowerPro

PowerPro BC

Multi pole arrester (class I+II) for one and three phase systems. Available for all net systems.



- Test standard: IEC 61643-1 / EN 61643-11
- Vibration and Shock according standard: DIN EN 60068-2-6 and DIN EN 60068-2-27
- NEW: only one remote signalling contact (FM) (internal wire connection)
- Optional remote signalling contact (FM)
- Remote signalling contact: break contact
- Degree of protection according to IEC EN 60529: IP 20
- Mounting on 35 mm DIN rail
- No leakage currents, thus, allowing installation upstream of power meters

				
Technical Data	PP BC TNS 25/100	PP BC TNS 25/100-350	PP BC TNC 25/75	PP BC TNC 25/75-350
Article-No.	37 39 50	38 51 40	37 39 80	38 51 20
Nominal voltage AC	UN 230/400 V~	230/400 V~	230/400 V~	230/400 V~
Max. continuous operating voltage AC	Uc 255 V~	350 V~	255 V~	350 V~
Insulation resistance	Risol >10 GΩ	>10 GΩ	>10 GΩ	> 10 GΩ
Protection level at 100% lightning imp. sparkover voltage (1.2/50µs)	Up ≤ 2,5 kV	≤ 2,5 kV	≤ 2,5 kV	≤ 2,5 kV
Voltage protection level at limp L-PE	Up ≤ 2,5 kV	≤ 2,5 kV	≤ 2,5 kV	≤ 2,5 kV
Response time	tA < 50 ns	< 50 ns	< 50 ns	< 50 ns
Lightning impulse current (10/350) L1+L2+L3+N-PE	Itotal 100 kA	100 kA	75 kA	75 kA
Lightning impulse current (10/350) L,N-PE	limp 25 kA	25 kA	25 kA	25 kA
Follow-on current extinguishing capability at Uc (50/60 Hz)	Ifi 4 kA	4 kA	4 kA	4 kA
Short-circuit withstand capability at max. back-up fuse	Ik 50 kAeff	50 kAeff	50 kAeff	50 kAeff
Max. acceptable back-up fuse F2 (spur wiring)	250 A gL/gG	250 A gL/gG	250 A gL/gG	250 A gL/gG
Max. acceptable back-up fuse F1 (V wiring)	125 A gL/gG	125 A gL/gG	125 A gL/gG	125 A gL/gG
Operating temperature range	TU -40 - +80 °C	-40 - +80 °C	-40 - +80 °C	-40 - +80 °C
Max. conductor cross section	50mm ² stranded/35mm ² flexible	50mm ² stranded/35mm ² flexible	50mm ² stranded/35mm ² flexible	50mm ² stranded/35mm ² flexible
Recommended conductor cross section	25 mm ²	25 mm ²	25 mm ²	25 mm ²
Max. connection torque for terminals	4,5 Nm	4,5 Nm	4,5 Nm	4,5 Nm
Enclosure material / colour	polycarbonate (halogen-free) UL 94-V0 / yellow			





With remote signalling contact (FM)	PP BC TNS 25/100/FM	PP BC TNS 25/100/FM-350	PP BC TNC 25/75/FM	PP BC TNC 25/75/FM-350
Article-No.	37 39 52	38 51 50	37 39 82	38 51 30
Switching capacity	250 V/2 A	250 V/2 A	250 V/2 A	250 V/2 A
Max. conductor cross section FM	1,5 mm ²	1,5 mm ²	1,5 mm ²	1,5 mm ²

Dimension drawing, see pages 194 to 198



SURGE PROTECTION FOR POWER SUPPLY SYSTEMS

AC POWER SUPPLY

					
Technical Data		PP BC TNC 440	PP BC TT 25/100	PP BC TT 25/100-350	PP BC TT1+1 25/100
Article-No.		37 39 81	37 39 20	38 51 60	38 11 32
Nominal voltage AC	UN	400/690 V~	230/400 V~	230 / 400 V~	230/400 V~
Max. continuous operating voltage AC	Uc	440 V~	255 (275) V~	350 V~	255 V~
Insulation resistance	Risol	>10 GΩ	>10 GΩ	>10 GΩ	>10 GΩ
Protection level at 100% lightn. imp. sparkover voltage (1.2/50µs)	Up	≤ 2.0 kV	≤ 2,5 kV	≤ 2,5 kV	≤ 2,5 kV
Voltage protection level at limp L-PEN	Up	≤ 2.0 kV	≤ 2,5 kV	≤ 2,5 kV	≤ 2,5 kV
Response time	tA	<50 ns	<50 ns	<50 ns	<50 ns
Lightning impulse current (10/350) L1+L2+L3-PEN	Itotal	75 kA	100 kA	100 kA	100 kA
Lightning impulse current (10/350) L-PEN	limp	25 kA	25 kA	25 kA	25 kA
Follow-on current extinguishing capability at Uc (50/60 Hz) I _{fi}		0,75 kA	4 kA	4 kA	4 kA
Short-circuit withstand capability at max. back-up fuse	I _k	50 kA _{eff}	50 kA _{eff}	50 kA _{eff}	50 kA _{eff}
Max. acceptable back-up fuse F2 (spur wiring)		63 A gL/gG	250 A gL/gG	250 A gL/gG	250 A gL/gG
Max. acceptable back-up fuse F1 (V wiring)		63 A gL/gG	125 A gL/gG	125 A gL/gG	125 A gL/gG
Operating temperature range	TU	-40 - +80 °C	-40 - +80 °C	-40 - +80 °C	-40 - +80 °C
Max. conductor cross section		50mm ² stranded/35mm ² flexible	50mm ² stranded/35mm ² flexible	50mm ² stranded/35mm ² flexible	50mm ² stranded/35mm ² flexible
Recommended conductor cross section		25 mm ²	25 mm ²	25 mm ²	25 mm ²
Max. connection torque for terminals		4,5 Nm	4,5 Nm	4,5 Nm	4,5 Nm
Enclosure material / colour		polycarbonate (halogen-free) UL 94-V0 / yellow			

With remote signalling contact (FM)		PP BC TNC 440/FM	PP BC TT 25/100/FM	PP BC TT 25/100/FM-350	PP BC TT1+1 25/100/FM
Article-No.		37 39 83	37 39 22	38 51 70	38 11 33
Switching capacity		250 V/2 A	250 V/2 A	250 V/2 A	250 V/2 A
Max. conductor cross section FM		1,5 mm ²	1,5 mm ²	1,5 mm ²	1,5 mm ²

				
Technical Data		PP BC TT1+1 25/100-350	PP BC TN 25/50	PP BC TN 25/50-350
Article-No.		38 52 00	38 12 12	38 51 80
Nominal voltage AC	UN	230/400 V~	230/400 V~	230/400 V~
Max. continuous operating voltage AC	Uc	350 V~	255 V~	350 V~
Insulation resistance	Risol	> 10 GΩ	>10 GΩ	> 10 GΩ
Protection level at 100% lightn. imp. sparkover voltage (1.2/50µs)	Up	≤ 2,5 kV	≤ 2,5 kV	≤ 2,5 kV
Voltage protection level at limp L-N	Up	≤ 2,5 kV	≤ 2,5 kV	≤ 2,5 kV
Response time	tA	< 50 ns	< 50 ns	< 50 ns
Lightning impulse current (10/350) L+N-PE	Itotal	100 kA	50 kA	50 kA
Lightning impulse current (10/350) L-N	limp	25 kA	25 kA	25 kA
Lightning impulse current (10/350) N-PE	limp	100 kA	-	-
Follow-on current extinguishing capability at Uc (50/60 Hz) I _{fi}		4 kA	4,0 (IEC:3.0) kA	4 kA
Short-circuit withstand capability at max. back-up fuse	I _k	50 kA _{eff}	50 kA _{eff}	50 kA _{eff}
Max. acceptable back-up fuse F2 (spur wiring)		250 A gL/gG	250 A gL/gG	250 A gL/gG
Max. acceptable back-up fuse F1 (V wiring)		125 A gL/gG	125 A gL/gG	125 A gL/gG
Operating temperature range	TU	-40 - +80 °C	-40 - +80 °C	-40 - +80 °C
Max. conductor cross section		50mm ² stranded/35mm ² flexible	50mm ² stranded/35mm ² flexible	50mm ² stranded/35mm ² flexible
Recommended conductor cross section		25 mm ²	25 mm ²	25 mm ²
Max. connection torque for terminals		4,5 Nm	4,5 Nm	4,5 Nm

With remote signalling contact (FM)		PP BC TT1+1 25/100/FM-350	PP BC TN 25/50/FM	PP BC TN 25/50/FM-350
Article-No.		38 52 10	38 12 13	38 51 90
Switching capacity		250 V/2 A	250 V/2 A	250 V/2 A
Max. conductor cross section FM		1,5 mm ²	1,5 mm ²	1,5 mm ²



Combined arrester Type 1 + 2 for AC power supplies / SumPro

SumPro BC

NPE lightning current arrester (class I+II) based on isolating spark gap technology. Single pole NPE lightning current arrester.

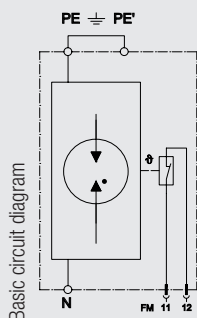

- No blow-out vents, thus, not requiring any safety clearance to other installations
- Discharge capacity up to 100 kA (10/350 μ s)
- High insulation resistance

		
Technical Data	SP BC NPE 100	
Article-No.	37 38 23	
Nominal alternating voltage (50/60Hz)	UN	230/400 V~
Max. continuous operating voltage AC (50/60Hz)	Uc	350 V~
Insulation resistance	Risol	> 10 G Ω
Protection level at 100% lightn. imp. sparkover voltage (1.2/50 μ s)	Up	\leq 1.5 kV
Voltage protection level at limp (10/350)	Up	\leq 1.5 kV
Response time	tA	< 50 ns
Nominal discharge current (8/20 μ s) N-PE	In	100 kA
Lightning impulse current (10/350 μ s) [N-PE]	limp	100 kA
Short-circuit withstand capability at max. back-up fuse	Ik	50 kAeff
Operating temperature range	TU	-40 - +80 °C
Max. conductor cross section		50mm ² stranded/35mm ² flexible
Recommended conductor cross section		25 mm ²
Max. connection torque for terminals		4.5 Nm
Degree of protection (IEC EN 60529)		IP 20
Enclosure material / colour		polycarbonate (halogen-free) UL 94-V0 / yellow
Mounting on		35 mm DIN rail (DIN EN 50 022)
With remote signalling contact (FM)	SP BC NPE 100/FM	
Article-No.	37 38 24	
Switching capacity	250 V/2 A	
Max. conductor cross section FM	1,5 mm ²	

Dimension drawing, see pages 194 to 198





Combined arrester Type 1 + 2 for AC power supplies / Wind Energy Converter

PowerPro BC 50

For lightning-protection equipotential bonding in 400 V TN-C systems e. g. Wind generator protection.

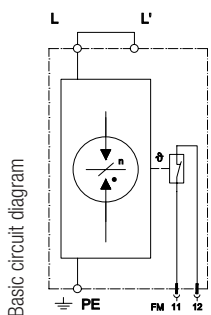
- One pole combined arrester class I+II
- New developed ceramical spark gap
- Low protection level
- High self-extinguishing capability without tripping fuses
- Optional remote signalling contact (FM)
- Remote signalling contact: break contact





		without fig.
Technical Data	PP BC 50-440	PP BC 50-440/FM
Article-No.	37 45 00	37 45 01
Nominal voltage AC	UN 400 V~	400 V~
Max. continuous operating voltage AC	Uc 440 V	440 V
Insulation resistance	Risol > 10 GΩ	> 10 GΩ
Protection level at 100% lighn. imp. sparkover voltage (1.2/50µs)	Up 2.5 kV	2.5 kV
Voltage protection level at limp (10/350)	Up 2.5 kV	2.5 kV
Response time	tA 100 ns	100 ns
Lightning impulse current (10/350) pro Pol	Iimp 50 kA	50 kA
Follow-on current extinguishing capability at Uc (50/60 Hz) I _{fi}	10 kA	10 kA
Short-circuit withstand capability at max. back-up fuse	I _k 50 kAeff	50 kAeff
Operating temperature range	TU -40 - +80 °C	-40 - +80 °C
Max. conductor cross section	50mm ² stranded/35mm ² flexible	50mm ² stranded/35mm ² flexible
Recommended conductor cross section	25 mm ²	25 mm ²
Max. connection torque for terminals	4.5 Nm	4.5 Nm
Enclosure material / colour	polycarbonate (halogen-free) UL 94-V0 / yellow	
Degree of protection (IEC EN 60529)	IP 20	IP 20
Mounting on	35 mm DIN rail (DIN EN 50 022)	
FM contact / contact Type		break contact
Switching capacity		250 V/2 A

PP BC TNC 50-400/690

For lightning protection equipotential bonding in 400 V TN-C systems e. g. Wind generator protection.

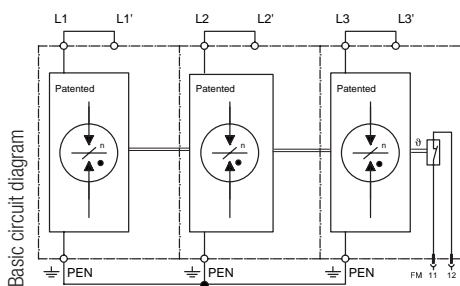
- Combined three-pole SPD, fully prewired
- Low protection level
- Optional remote signalling contact (FM)
- NEW: only one remote signalling contact (FM) (internal wire connection)
- Remote signalling contact: break contact



		without fig.
Technical Data	PP BC TNC 50-400/690	PP BC TNC 50-400/690/FM
Article-No.	37 45 04	37 45 05
Nominal voltage AC	UN 400/690 V~	400/690 V~
Max. continuous operating voltage AC	Uc 440 V	440 V
Insulation resistance	Risol > 10 GΩ	> 10 GΩ
Protection level at 100% lighn. imp. sparkover voltage (1.2/50µs)	Up 2.5 kV	2.5 kV
Voltage protection level at limp (10/350)	Up 2.5 kV	2.5 kV
Response time	tA 100 ns	100 ns
Lightning impulse current (10/350) pro Pol	Iimp 50 kA	50 kA
Follow-on current extinguishing capability at Uc (50/60 Hz) I _{fi}	10 kA	10 kA
Short-circuit withstand capability at max. back-up fuse	I _k 50 kAeff	50 kAeff
Operating temperature range	TU -40 - +80 °C	-40 - +80 °C
Max. conductor cross section	50mm ² stranded/35mm ² flexible	50mm ² stranded/35mm ² flexible
Recommended conductor cross section	25 mm ²	25 mm ²
Max. connection torque for terminals	4.5 Nm	4.5 Nm
Enclosure material / colour	polycarbonate (halogen-free) UL 94-V0 / yellow	
Degree of protection (IEC EN 60529)	IP 20	IP 20
Mounting on	35 mm DIN rail (DIN EN 50 022)	
FM contact / contact Type		break contact
Switching capacity		250 V/2 A

Dimension drawing, see pages 194 to 198



Combined arrester Type 1 + 2 for AC power supplies / IsoPro

IsoPro BC





Multipole modular combined arrester (class I+II) for one and three phase systems with discharge capacity up to 100 kA (10/350 μs). Available for all net systems. All-in-one modular protection unit, ready for connection.

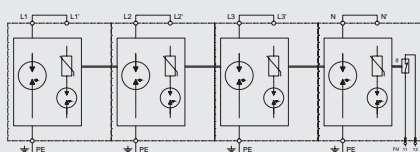

Basic circuit diagram



- Test standard: IEC 61643-1 / EN 61643-11
- Vibration and Shock according standard: DIN EN 60068-2-6 and DIN EN 60068-2-27
- NEW: only one remote signalling contact (FM) (internal wire connection)
- Optional remote signalling contact (FM)
- Remote signalling contact: break contact
- No leakage currents, thus, allowing installation upstream of power meters
- Degree of protection according to IEC EN 60529: IP 20
- Mounting on 35 mm DIN rail

				
Technical Data	IP BC TNS 25/100	IP BC TNS 25/100-350	IP BC TNS 60/100	IP BC TNS 60/100-350
Article-No.	38 12 22	38 53 40	38 11 47	38 53 20
Nominal voltage AC	UN 230/400 V~	230/400 V~	230/400 V~	230/400 V~
Max. continuous operating voltage AC	Uc 255 V~	350 V~	255 V~	350 V~
Insulation resistance	Risol >10 GΩ	> 10 GΩ	>10 GΩ	>10 GΩ
Protection level at 100% lightning imp. sparkover voltage (1.2/50μs)	Up ≤ 2,5 kV	≤ 2.5 kV	≤ 2,5 kV	≤ 2,5 kV
Voltage protection level at limp L-PE	Up ≤ 2,5 kV	≤ 2.5 kV	≤ 2,5 kV	≤ 2,5 kV
Response time	tA <50 ns	< 50 ns	<50 ns	<50 ns
Lightning impulse current (10/350) L1+L2+L3+N-PE	Itotal 100 kA	100 kA	100 kA	100 kA
Lightning impulse current (10/350) L,N-PE	limp 25 kA	25 kA	60 kA	60 kA
Short-circuit withstand capability at max. back-up fuse	Ik 50 kAeff	50 kAeff	50 kAeff	50 kAeff
Max. acceptable back-up fuse F2 (spur wiring)	160 A gL/gG	160 A gL/gG	160 A gL/gG	160 A gL/gG
Max. acceptable back-up fuse F1 (V wiring)	125 A gL/gG	125 A gL/gG	125 A gL/gG	125 A gL/gG
Operating temperature range	TU -40 - +80 °C	-40 - +80 °C	-40 - +80 °C	-40 - +80 °C
Max. conductor cross section	stranded 50/fine stranded 35 mm ²			
Recommended conductor cross section	25 mm ²	25 mm ²	25 mm ²	25 mm ²
Max. connection torque for terminals	4,5 Nm	4,5 Nm	4,5 Nm	4,5 Nm
Enclosure material / colour	polycarbonate (halogen-free) UL 94-V0 / yellow			





With remote signalling contact (FM)	IP BC TNS 25/100/FM	IP BC TNS 25/100/FM-350	IP BC TNS 60/100/FM	IP BC TNS 60/100/FM-350
Article-No.	38 12 23	38 53 50	38 11 48	38 53 30
Switching capacity	250 V/2 A	250 V/2 A	250 V/2 A	250 V/2 A
Max. conductor cross section FM	1,5 mm ²	1,5 mm ²	1,5 mm ²	1,5 mm ²

Dimension drawing, see pages 194 to 198







SURGE PROTECTION FOR POWER SUPPLY SYSTEMS

AC POWER SUPPLY





				
Technical Data	IP BC TNC 25/75	IP BC TNC 25/75-350	IP BC TNC 60/100	IP BC TNC 60/100-350
Article-No.	38 12 18	38 53 00	38 11 42	38 52 80
Nominal voltage AC	UN 230/400 V~	230/400 V~	230/400 V~	230/400 (250/440) V~
Max. continuous operating voltage AC	Uc 255 V~	350 V~	255 V~	350 V~
Insulation resistance	Risol >10 GΩ	>10 GΩ	>10 GΩ	> 10 GΩ
Protection level at 100% lightning imp. sparkover voltage (1.2/50µs)	Up ≤ 2,5 kV	≤ 2,5 kV	≤ 2,5 kV	≤ 2,5 kV
Voltage protection level at limp L-PEN	Up ≤ 2,5 kV	≤ 2,5 kV	≤ 2,5 kV	≤ 2,5 kV
Response time	tA <50 ns	<50 ns	<50 ns	< 50 ns
Lightning impulse current (10/350) L1+L2+L3-PEN	Itotal 75 kA	75 kA	100 kA	100 kA
Lightning impulse current (10/350) L-PEN	limp 25 kA	25 kA	60 kA	60 kA
Short-circuit withstand capability at max. back-up fuse	Ik 50 kAeff	50 kAeff	50 kAeff	50 kAeff
Max. acceptable back-up fuse F2 (spur wiring)	160 A gL/gG	160 A gL/gG	160 A gL/gG	160 A gL/gG
Max. acceptable back-up fuse F1 (V wiring)	125 A gL/gG	125 A gL/gG	125 A gL/gG	125 A gL/gG
Operating temperature range	TU -40 - +80 °C	-40 - +80 °C	-40 - +80 °C	-40 - +80 °C
Max. conductor cross section	stranded 50/fine stranded 35 mm ²			
Recommended conductor cross section	25 mm ²	25 mm ²	25 mm ²	10/25 mm ²
Max. connection torque for terminals	4,5 Nm	4,5 Nm	4,5 Nm	4,5 Nm
Enclosure material / colour	polycarbonate (halogen-free) UL 94-V0 / yellow			

With remote signalling contact (FM)	IP BC TNC 25/75 /FM	IP BC TNC 25/75/FM-350	IP BC TNC 60/100/FM	IP BC TNC 60/100/FM-350
Article-No.	38 12 19	38 53 10	38 11 43	38 52 90
Switching capacity	250 V/2 A	250 V/2 A	250 V/2 A	250 V/2 A
Max. conductor cross section FM	1,5 mm ²	1,5 mm ²	1,5 mm ²	1,5 mm ²





				
Technical Data	IP BC TT 25/100	IP BC TT 25/100-350	IP BC TT 60/100	IP BC TT 60/100-350
Article-No.	38 12 26	38 53 80	38 11 52	38 53 60
Nominal voltage AC	UN 230/400 V~	230/400 V~	230/400 V~	230/400 V~
Max. continuous operating voltage AC	Uc 255 V~	350 V~	255 V~	350 V~
Insulation resistance	Risol >10 GΩ	> 10 GΩ	>10 GΩ	>10 GΩ
Protection level at 100% lightning imp. sparkover voltage (1.2/50µs)	Up ≤ 2,5 kV	≤ 2,5 kV	≤ 2,5 kV	≤ 2,5 kV
Voltage protection level at limp L-N	Up ≤ 2,5 kV	≤ 2,5 kV	≤ 2,5 kV	≤ 2,5 kV
Response time	tA <50 ns	< 50 ns	<50 ns	<50 ns
Lightning impulse current (10/350) L1+L2+L3+N-PE	Itotal 100 kA	100 kA	100 kA	100 kA
Lightning impulse current (10/350) L-N	limp 25 kA	25 kA	60 kA	60 kA
Lightning impulse current (10/350) N-PE	limp 100 kA	100 kA	100 kA	100 kA
Short-circuit withstand capability at max. back-up fuse	Ik 50 kAeff	50 kAeff	50 kAeff	50 kAeff
Max. acceptable back-up fuse F2 (spur wiring)	160 A gL/gG	160 A gL/gG	160 A gL/gG	160 A gL/gG
Max. acceptable back-up fuse F1 (V wiring)	125 A gL/gG	125 A gL/gG	125 A gL/gG	125 A gL/gG
Operating temperature range	TU -40 - +80 °C	-40 - +80 °C	-40 - +80 °C	-40 - +80 °C
Max. conductor cross section	stranded 50/fine stranded 35 mm ²			
Recommended conductor cross section	25 mm ²	25 mm ²	25 mm ²	25 mm ²
Max. connection torque for terminals	4,5 Nm	4,5 Nm	4,5 Nm	4,5 Nm
Enclosure material / colour	polycarbonate (halogen-free) UL 94-V0 / yellow			

With remote signalling contact (FM)	IP BC TT 25/100 /FM	IP BC TT 25/100-350 /FM	IP BC TT 60/100 /FM	IP BC TT 60/100-350 /FM
Article-No.	38 12 27	38 53 90	38 11 54	38 53 70
Switching capacity	250 V/2 A	250 V/2 A	250 V/2 A	250 V/2 A
Max. conductor cross section FM	1,5 mm ²	1,5 mm ²	1,5 mm ²	1,5 mm ²



				
Technical Data	IP BC TT1+1 25/100	IP BC TT1+1 25/100-350	IP BC TT1+1 60/100	IP BC TT1+1 60/100-350
Article-No.	38 12 30	38 54 60	38 11 57	38 54 40
Nominal voltage AC	UN 230/400 V~	230/400 V~	230/400 V~	230/400 V~
Max. continuous operating voltage AC	Uc 255 V~	350 V~	255 V~	350 V~
Insulation resistance	Risol >10 GΩ	> 10 GΩ	>10 GΩ	>10 GΩ
Protection level at 100% lightning imp. sparkover voltage (1.2/50µs)	Up ≤ 2,5 kV	≤ 2,5 kV	≤ 2,5 kV	≤ 2,5 kV
Voltage protection level at limp L-N	Up ≤ 2,5 kV	≤ 2,5 kV	≤ 2,5 kV	≤ 2,5 kV
Response time	tA <50 ns	< 50 ns	<50 ns	<50 ns
Lightning impulse current (10/350) L+N-PE	Itotal 100 kA	100 kA	100 kA	100 kA
Lightning impulse current (10/350) L-N	limp 25 kA	25 kA	60 kA	60 kA
Lightning impulse current (10/350) N-PE	limp 100 kA	100 kA	100 kA	100 kA
Short-circuit withstand capability at max. back-up fuse	Ik 50 kAeff	50 kAeff	50 kAeff	50 kAeff
Max. acceptable back-up fuse F2 (spur wiring)	160 A gL/gG	160 A gL/gG	160 A gL/gG	160 A gL/gG
Max. acceptable back-up fuse F1 (V wiring)	125 A gL/gG	125 A gL/gG	125 A gL/gG	125 A gL/gG
Operating temperature range	TU -40 - +80 °C	-40 - +80 °C	-40 - +80 °C	-40 - +85 °C
Max. conductor cross section	stranded 50/fine stranded 35 mm²/35mm²			
Recommended conductor cross section	25 mm²	25 mm²	25 mm²	25 mm²
Max. connection torque for terminals	4,5 Nm	4,5 Nm	4,5 Nm	4,5 Nm
Enclosure material / colour	polycarbonate (halogen-free) UL 94-V0 / yellow			

With remote signalling contact (FM)	IP BC TT1+1 25/100/FM	IP BC TT1+1 25/100/FM-350	IP BC TT1+1 60/100 /FM	IP BC TT1+1 60/100-350
Article-No.	38 12 31	38 54 70	38 11 58	38 54 50
Switching capacity	250 V/2 A	250 V/2 A	250 V/2 A	250 V/2 A
Max. conductor cross section FM	1,5 mm²	1,5 mm²	1,5 mm²	1,5 mm²



				
Technical Data	IP BC TN 25/50	IP BC TN 25/50-350	IP BC TN 60/100	IP BC TN 60/100-350
Article-No.	38 12 38	38 54 20	38 12 34	38 54 00
Nominal voltage AC	UN 230/400 V~	230/400 V~	230/400 V~	230/400 V~
Max. continuous operating voltage AC	Uc 255 V~	350 V~	255 V~	350 V~
Insulation resistance	Risol >10 GΩ	> 10 GΩ	>10 GΩ	>10 GΩ
Protection level at 100% lightning imp. sparkover voltage (1.2/50µs)	Up ≤ 2,5 kV	≤ 2,5 kV	≤ 2,5 kV	≤ 2,5 kV
Voltage protection level at limp L-PE	Up ≤ 2,5 kV	≤ 2,5 kV	≤ 2,5 kV	≤ 2,5 kV
Response time	tA <50 ns	50 ns	<50 ns	<50 ns
Lightning impulse current (10/350) L+N-PE	Itotal 50 kA	50 kA	100 kA	100 kA
Lightning impulse current (10/350) L,N-PE	limp 25 kA	25 kA	60 kA	60 kA
Short-circuit withstand capability at max. back-up fuse	Ik 50 kAeff	50 kAeff	50 kAeff	50 kAeff
Max. acceptable back-up fuse F2 (spur wiring)	160 A gL/gG	160 A gL/gG	160 A gL/gG	160 A gL/gG
Max. acceptable back-up fuse F1 (V wiring)	125 A gL/gG	125 A gL/gG	125 A gL/gG	125 A gL/gG
Operating temperature range	TU -40 - +80 °C	-40 - +80 °C	-40 - +80 °C	-40 - +80 °C
Max. conductor cross section	stranded 50/fine stranded 35mm²			
Recommended conductor cross section	25 mm²	25 mm²	25 mm²	25 mm²
Max. connection torque for terminals	4,5 Nm	4,5 Nm	4,5 Nm	4,5 Nm
Enclosure material / colour	polycarbonate (halogen-free) UL 94-V0 / yellow			

With remote signalling contact (FM)	IP BC TN 25/50/FM	IP BC TN 25/50/FM-350	IP BC TN 60/100/FM	IP BC TN 60/100/FM-350
Article-No.	38 12 39	38 54 30	38 12 35	38 54 10
Switching capacity	250 V/2 A	250 V/2 A	250 V/2 A	250 V/2 A
Max. conductor cross section FM	1,5 mm²	1,5 mm²	1,5 mm²	1,5 mm²







SURGE PROTECTION FOR POWER SUPPLY SYSTEMS

AC POWER SUPPLY

				
Technical Data		IP BC TT 60/100-LED	IP BC TT2+1 60/100-LED	IP BC TT1+1 60/100-LED
Article-No.		38 11 53	38 11 60	38 11 59
Nominal voltage AC	UN	230/400 V~	230/400 V~	230/400 V~
Max. continuous operating voltage AC	Uc	255 V~	255 V~	255 V~
Insulation resistance	Risol	>10 GΩ	>10 GΩ	>10 GΩ
Protection level at 100% lightning imp. sparkover voltage (1.2/50µs)	Up	≤ 2,5 kV	≤ 2,5 kV	≤ 2,5 kV
Voltage protection level at limp L-PE	Up	≤ 2,5 kV	≤ 2,5 kV	≤ 2,5 kV
Response time	tA	<50 ns	<50 ns	<50 ns
Lightning impulse current (10/350)	Itotal	100 kA	100 kA	100 kA
Lightning impulse current (10/350) L-N	limp	60 kA	60 kA	60 kA
Short-circuit withstand capability at max. back-up fuse	Ik	50 kAeff	50 kAeff	50 kAeff
Max. acceptable back-up fuse F2 (spur wiring)		160 A gL/gG	160 A gL/gG	160 A gL/gG
Max. acceptable back-up fuse F1 (V wiring)		125 A gL/gG	125 A gL/gG	125 A gL/gG
Operating temperature range	TU	-40 - +80 °C	-40 - +80 °C	-40 - +80 °C
Max. conductor cross section		stranded 50/fine stranded 35mm ²		
Recommended conductor cross section		25 mm ²	25 mm ²	25 mm ²
Max. connection torque for terminals		4,5 Nm	4,5 Nm	4,5 Nm
Enclosure material / colour		polycarbonate (halogen-free) UL 94-V0 / yellow		

With remote signalling contact (FM)	IP BC TT 60/100-LED/FM	IP BC TT2+1 60/100-LED/FM	
Article-No.	38 11 63	38 11 61	-
Switching capacity	250 V/2 A	250 V/2 A	-
Max. conductor cross section FM	1,5 mm ²	1,5 mm ²	-

					
Technical Data		IP BC 25	IP BC 60	IP BC 60-350	IP BC 60kA-350 2kV
Article-No.		37 38 25	37 38 30	55 05 20	55 05 22
Nominal voltage AC	UN	230/400 V~	230/400 V~	230/400 V~	230/400 V~ to 240/415 V~
Max. continuous operating voltage AC	Uc	255 V~	255 V~	350 V~	350 V~
Insulation resistance	Risol	>10 GΩ	>10 GΩ	>10 GΩ	>10 GΩ
Protection level at 100% lightning imp. sparkover voltage (1.2/50µs)	Up	≤ 2,5 kV	≤ 2,5 kV	≤ 2,5 kV	≤ 2,0 kV
Voltage protection level at limp (10/350)/5 kA (10/350) [L-PE]	Up	≤ 2,5 / ≤ 2,0 kV	≤ 2,5 / ≤ 2,0 kV	≤ 2,5 / ≤ 2,0 kV	≤ 2,0 kV
Response time	tA	<50 ns	<50 ns	<50 ns	<50 ns
Lightning impulse current (10/350) pro Pol	limp	25 kA	60 kA	60 kA	60 kA
Short-circuit withstand capability at max. back-up fuse	Ik	50 kAeff	50 kAeff	50 kAeff	50 kAeff
Max. acceptable back-up fuse F2 (spur wiring)		160 A gL/gG	160 A gL/gG	160 A gL/gG	160 A gL/gG
Max. acceptable back-up fuse F1 (V wiring)		125 A gL/gG	125 A gL/gG	125 A gL/gG	125 A gL/gG
Operating temperature range	TU	-40 - +80 °C	-40 - +80 °C	-40 - +80 °C	-40 - +80 °C
Max. conductor cross section		stranded 50/fine stranded 35mm ²			
Recommended conductor cross section		25 mm ²	25 mm ²	25 mm ²	25 mm ²
Max. connection torque for terminals		4,5 Nm	4,5 Nm	4,5 Nm	4,5 Nm
Enclosure material / colour		polycarbonate (halogen-free) UL 94-V0 / yellow			

With remote signalling contact (FM)	IP BC 25/FM	IP BC 60/FM	IP BC 60/FM-350	IP BC 60kA/FM-350 2kV
Article-No.	37 38 26	55 05 18	55 05 21	55 05 23
Switching capacity	250 V/2 A	250 V/2 A	250 V/2 A	250 V/2 A
Max. conductor cross section FM	1,5 mm ²	1,5 mm ²	1,5 mm ²	1,5 mm ²

Dimension drawing, see pages 194 to 198





Combined arrester Type 1+2+3 for AC power supplies / CT series

CT-T1+2+3

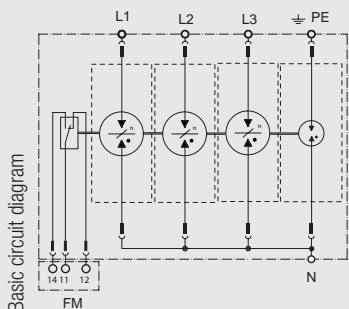
Combined surge arrester (class I+II+III) with rare-gas-filled spark gap and very low protection level < 1.0 kV. They provide extremely high discharge capabilities with at the same time very low protection levels and they also do not need any damageable internal or external electronic trigger.



- Applicable at the boundaries LPZ 0A - 2
- Test standard: IEC 61643-1 / EN 61643-11
- Vibration and Shock according standard: DIN EN 60068-2-6 and DIN EN 60068-2-27
- Mounting on 35 mm DIN rail
- Enclosure material: thermoplastic with the colors yellow and black
- Degree of protection according to IEC EN 60529: IP 20
- Inflammability class according to UL 94 V0
- Remote changeover contact
- No leakage currents, thus, allowing installation upstream of power meters

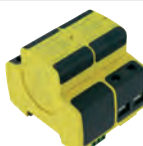
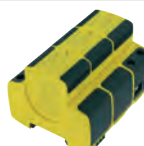

				
Technical Data	CT-T1+2+3/3+1-350-FM	CT-T1+2+3/3+0-350-FM	CT-T1+2+3/2+0-350-FM	CT-T1+2+3/2+1-350-FM
Article-No.	96 04 01	96 04 05	96 04 09	96 04 13
EC category/EN type	Type 1 + 2 + 3 (class I+II+III)	Type 1 + 2 + 3 (class I+II+III)	Type 1 + 2 + 3 (class I+II+III)	Type 1 + 2 + 3 (class I+II+III)
Nominal voltage	UN 230/400 V	230/400 V	230/400 V	230/400 V
Max. continuous operating voltage AC	Uc 350 V~	350 V~	350 V~	350 V~
Lightning impulse current (10/350) total	I _{total} 100 kA	75 kA	50 kA	100 kA
Lightning impulse current (10/350) L-N/N-PE/L-PEN	I _{imp} 25 / 100 / - kA	- / - / 75 (3L-PEN) kA	25 / - / - kA	25 / 100 / - kA
Nominal discharge current (8/20) L-N/N-PE/L-PEN	I _n 25 / 100 / - kA	- / - / 75 (3L-PEN) kA	25 / - / - kA	25 / 100 / - kA
Voltage protection level at I _{imp}	U _p ≤ 1,0 kV	≤ 1,0 kV	≤ 1,0 kV	≤ 1,0 kV
Follow current quenching capacity AC L-N (260V AC)	I _{fi} 4 kA _{eff}	4 kA _{eff}	4 kA _{eff}	4 kA _{eff}
Follow current quenching capacity AC N-PE	I _{fi} 100 A _{eff}	-	-	100 A _{eff}
Short-circuit withstand capability at max. back-up fuse	I _{lk} 50 kA _{eff}	50 kA _{eff}	50 kA _{eff}	50 kA _{eff}
Max. acceptable backup fuse (branch wiring)	250 A gL/gG	250 A gL/gG	250 A gL/gG	250 A gL/gG
Max. acceptable backup fuse (V-type through wiring)	125 A gL/gG	125 A gL/gG	125 A gL/gG	125 A gL/gG
Operating temperature range	TU -40 - +80 °C	-40 - +80 °C	-40 - +80 °C	-40 - +80 °C
Min. conductor cross section at terminals	10mm ² solid/flexible	10mm ² solid/flexible	10mm ² solid/flexible	10mm ² solid/flexible
Max. conductor cross section	50mm ² stranded/35mm ² flexible	50mm ² stranded/35mm ² flexible	50mm ² stranded/35mm ² flexible	50mm ² stranded/35mm ² flexible
Dimension (DIN 43880)	147,2	113,5 mm	76,5 mm	113,5 mm
Max. operating voltage remote contact	1 A AC/200 mA DC	1 A AC/200 mA DC	1 A AC/200 mA DC	1 A AC/200 mA DC
Max. operating voltage remote contact	250 V AC/125 V DC	250 V AC/125 V DC	250 V AC/125 V DC	250 V AC/125 V DC
Composed of: number of moduls	3x 96 04 25 + 1x 96 02 38	3x 96 04 25	2x 96 04 25	2x 96 04 25 + 1x 96 02 38
Power supply system	3 phase TNS and TT systems	3 phase TNC systems	1 phase TN systems	2 -pole TT systems

Dimension drawing, see pages 194 to 198



SURGE PROTECTION FOR POWER SUPPLY SYSTEMS

AC POWER SUPPLY

		
Technical Data	CT-T1+2+3/1+1-350-FM	CT-T1+2+3/1+0-350-FM
Article-No.	96 04 17	96 04 21
EC category/EN type	Type 1 + 2 + 3 (class I+II+III)	Type 1 + 2 + 3 (class I+II+III)
Nominal voltage	UN 230/400 V	230/400 V
Max. continuous operating voltage AC	Uc 350 V~	350 V~
Lightning impulse current (10/350) total	Itotal 100 kA	75 kA
Lightning impulse current (10/350) L-N/N-PE/L-PEN	limp 25 / 50 / - kA	25 / - / - kA
Nominal discharge current (8/20) L-N/N-PE/L-PEN	In 25 / 50 / - kA	25 / - / 25 kA
Voltage protection level at limp	Up ≤ 1,0 kV	≤ 1,0 kV
Follow current quenching capacity AC L-N (260V AC)	Ifi 4 kAeff	4 kAeff
Follow current quenching capacity AC N-PE	Ifi 100 Aeff	-
Short-circuit withstand capability at max. back-up fuse	Ik 50 kAeff	50 kAeff
Max. acceptable backup fuse (branch wiring)	250 A gL/gG	250 A gL/gG
Max. acceptable backup fuse (V-type through wiring)	125 A gL/gG	125 A gL/gG
Operating temperature range	TU -40 - +80 °C	-40 - +80 °C
Min. conductor cross section at terminals	10mm ² solid/flexible	10mm ² solid/flexible
Max. conductor cross section	50mm ² stranded/35mm ² flexible	50mm ² stranded/35mm ² flexible
Dimension (DIN 43880)	76,5 mm	39,8 mm
Max. operating voltage remote contact	1 A AC/200 mA DC	1 A AC/200 mA DC
Max. operating voltage remote contact	250 V AC/125 V DC	250 V AC/125 V DC
Composed of: number of moduls	1x 96 04 25 + 1x 96 02 38	1x 96 04 25
Power supply system		

Accessories		
	CT-T1+2+3-350-M	CT-T1-NPE-M
Article-No.	96 04 25	96 02 38



Replacement protective plug for combined lightning current discharge and surge arresters.

Dimension drawing, see pages 194 to 198





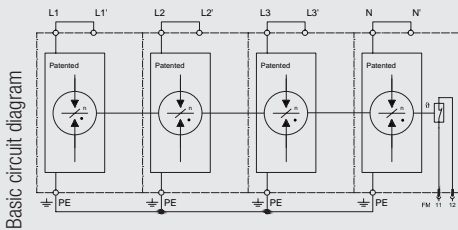
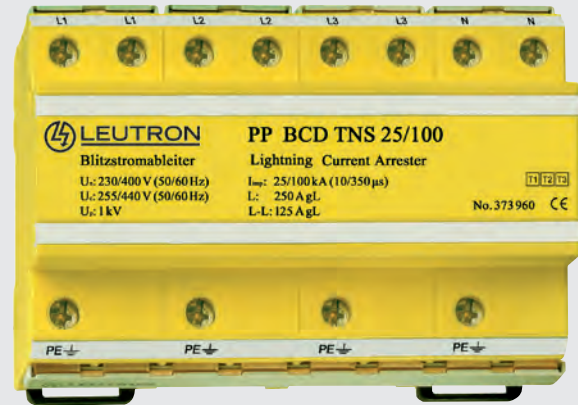

Combined arrester Type 1 + 2 + 3 for AC power supplies

PowerPro BCD

Multi pole arrester (class I+II+III) for one and three phase systems. The installation place of the PowerPro BCD is the main distribution board upstream or downstream of the power meter. According to the lightning protection zones concept in IEC DIN EN 62305 part 1-4 (VDE 0185-305-1-4), it can universally be installed at the transition 0A to 2.



- Vibration and Shock according standard: DIN EN 60068-2-6 and DIN EN 60068-2-27
- Optional remote signalling contact (FM)
- Remote signalling contact: break contact
- Discharge capacity up to 100 kA (10/350 μ s)
- No leakage currents, thus, allowing installation upstream of power meters
- NEW: only one remote signalling contact (FM) (internal wire connection)

				
Technical Data	PP BCD TNS 25/100	PP BCD TNS 25/100-350	PP BCD TNC 25/75	PP BCD TNC 25/75-350
	37 39 60	38 50 20	37 39 90	38 50 00
Nominal voltage AC	UN 230/400 V~	230/400 V~	230/400 V~	230/400 V~
Max. continuous operating voltage AC	Uc 255 V~	350 V~	255 V~	350 V~
Insulation resistance	Risol >10 G Ω	>10 G Ω	> 10 G Ω	>10 G Ω
Protection level at 100% lightning imp. sparkover voltage (1.2/50 μ s)	Up \leq 1,0 kV	\leq 1,0 kV	\leq 1,0 kV	\leq 1,0 kV
Voltage protection level at limp L-PE	Up \leq 1,0 kV	\leq 1,0 kV	\leq 1,0 kV	\leq 1,0 kV
Response time	tA <50 ns	<50 ns	< 50 ns	<50 ns
Lightning impulse current (10/350) L1+L2+L3+N-PE	Itotal 100 kA	100 kA	75 kA	75 kA
Lightning impulse current (10/350) L,N-PE	limp 25 kA	25 kA	25 kA	25 kA
Folgestromlöschvermögen bei Uc (50/60Hz)	Ifi 4 kA	4 kA	4 kA	4 kA
Short-circuit withstand capability at max. back-up fuse	Ik 50 kAeff	50 kAeff	50 kAeff	50 kAeff
Max. acceptable back-up fuse F1 (V wiring)	125 A gL/gG	125 A gL/gG	250 A gL/gG	250 A gL/gG
Max. acceptable back-up fuse F2 (spur wiring)	250 A gL/gG	250 A gL/gG	125 A gL/gG	125 A gL/gG
Operating temperature range	TU -40 - +80 °C	-40 - +80 °C	-40 - +80 °C	-40 - +80 °C
Max. conductor cross section	stranded 50/fine stranded 35mm ²			
Recommended conductor cross section	25 mm ²	25 mm ²	25 mm ²	25 mm ²
Max. connection torque for terminals	4,5 Nm	4,5 Nm	4,5 Nm	4,5 Nm
Enclosure material / colour	polycarbonate (halogen free) UL 94-V0/yellow			



With remote signalling contact (FM)	PP BCD TNS 25/100/FM	PP BCD TNS 25/100-350/FM	PP BCD TNC 25/75/FM	PP BCD TNC 25/75-350
Article-No.	37 39 62	38 50 30	37 39 92	38 50 10
Switching capacity	250 V/2 A	250 V/2 A	250 V/2 A	250 V/2 A
Max. conductor cross section FM	1,5 mm ²	1,5 mm ²	1,5 mm ²	1,5 mm ²

Dimension drawing, see pages 194 to 198





SURGE PROTECTION FOR POWER SUPPLY SYSTEMS

AC POWER SUPPLY





				
Technical Data		PP BCD TT 25/100	PP BCD TT 25/100-350	PP BCD TT2+1 25/100
Article-No.		37 39 30	38 50 40	37 39 34
Nominal voltage AC	UN	230/400 V~	230/400 V~	230/400 V~
Max. continuous operating voltage AC	Uc	255 V~	350 V~	255 V~
Insulation resistance	Risol	>10 GΩ	>10 GΩ	>10 GΩ
Protection level at 100% lightning imp. sparkover voltage (1.2/50µs)	Up	≤ 1,0 kV	≤ 1,0 kV	≤ 1,0 kV
Voltage protection level at limp L-N	Up	≤ 1,0 kV	≤ 1,0 kV	≤ 1,0 kV
Response time	tA	<50 ns	<50 ns	<50 ns
Lightning impulse current (10/350) L1+L2+L3+N-PE	Itotal	100 kA	100 kA	100 kA
Lightning impulse current (10/350) L-N	Iimp	25 kA	25 kA	25 kA
Lightning impulse current (10/350) N-PE	Iimp	100 kA	100 kA	100 kA
Follow-on current extinguishing capability at Uc (50/60 Hz) I _{fi}		4,0 kA	4 kA	4 kA
Short-circuit withstand capability at max. back-up fuse 250 A gL	I _{sk}	50 kA _{eff}	50 kA _{eff}	50 kA _{eff}
Max. acceptable back-up fuse F1 (V wiring)		125 A gL/gG	125 A gL/gG	125 A gL/gG
Max. acceptable back-up fuse F2 (spur wiring)		250 A gL/gG	250 A gL/gG	250 A gL/gG
Operating temperature range	TU	-40 - +80 °C	-40 - +80 °C	-40 - +80 °C
Max. conductor cross section		50mm ² stranded/35mm ² flexible	50mm ² stranded/35mm ² flexible	50mm ² stranded/35mm ² flexible
Recommended conductor cross section		25 mm ²	25 mm ²	25 mm ²
Max. connection torque for terminals		4,5 Nm	4,5 Nm	4,5 Nm

With remote signalling contact (FM)		PP BCD TT 25/100/FM	PP BCD TT 25/100/FM-350	PP BCD TT2+1 25/100/FM
Article-No.		37 39 32	38 50 50	37 39 36
Switching capacity		250 V/2 A	250 V/2 A	250 V/2 A
Max. conductor cross section FM		1,5 mm ²	1,5 mm ²	1,5 mm ²





				
Technical Data		PP BCD TT1+1 25/100	PP BCD TT1+1 25/100-350	PP BCD TT1+1 25/100/2LED
Article-No.		38 11 34	38 50 80	38 11 36
Nominal voltage AC	UN	230/400 V~	230/400 V~	230/400 V~
Max. continuous operating voltage AC	Uc	255 V~	350 V~	255 V~
Insulation resistance	Risol	> 10 GΩ	> 10 GΩ	> 10 GΩ
Protection level at 100% lightning imp. sparkover voltage (1.2/50µs)	Up	≤ 1,0 kV	≤ 1,0 kV	≤ 1,0 kV
Voltage protection level at limp L-N	Up	≤ 1,0 kV	≤ 1,0 kV	≤ 1,0 kV
Response time	tA	< 50 ns	< 50 ns	< 50 ns
Lightning impulse current (10/350) L-N	Iimp	25 kA	25 kA	25 kA
Lightning impulse current (10/350) N-PE	Iimp	100 kA	100 kA	100 kA
Follow-on current extinguishing capability at Uc (50/60 Hz) I _{fi}		4 kA	4 kA	4 kA
Short-circuit withstand capability at max. back-up fuse	I _{sk}	50 kA _{eff}	50 kA _{eff}	50 kA _{eff}
Max. acceptable back-up fuse F2 (spur wiring)		250 A gL/gG	250 A gL/gG	250 A gL/gG
Max. acceptable back-up fuse F1 (V wiring)		125 A gL/gG	125 A gL/gG	125 A gL/gG
Operating temperature range	TU	-40 - +80 °C	-40 - +80 °C	-40 - +80 °C
Max. conductor cross section		50mm ² stranded/35mm ² flexible	50mm ² stranded/35mm ² flexible	50mm ² stranded/35mm ² flexible
Recommended conductor cross section		25 mm ²	25 mm ²	25 mm ²
Max. connection torque for terminals		4,5 Nm	4,5 Nm	4,5 Nm
Enclosure material / colour		polycarbonate (halogen free) UL 94-V0/yellow		

With remote signalling contact (FM)		PP BCD TT1+1 25/100/FM	PP BCD TT1+1 25/100/FM-350
Article-No.		38 11 35	38 50 90
Switching capacity		250 V/2 A	250 V/2 A
Max. conductor cross section FM		1,5 mm ²	1,5 mm ²



				
Technical Data	PP BCD TN 25/50	PP BCD TN 25/50-350	PP BCD TN 25/50/LED	PP BCD TN 25/50/LED-350
Article-No.	38 12 14	38 50 60	37 12 00	38 51 00
Nominal voltage AC	UN 230/400 V~	230/400 V~	230/400 V~	230/400 V~
Max. continuous operating voltage AC	Uc 255 V~	350 V~	255 V~	350 V~
Insulation resistance	Risol >10 GΩ	>10 GΩ	> 10 GΩ	>10 GΩ
Protection level at 100% lightning imp. sparkover voltage (1.2/50μs)	Up ≤ 1,0 kV	≤ 1,0 kV	≤ 1,0 kV	≤ 1,0 kV
Voltage protection level at limp L-PE	Up ≤ 1,0 kV	≤ 1,0 kV	≤ 1,0 kV	≤ 1,0 kV
Response time	tA <50 ns	<50 ns	< 50 ns	<50 ns
Lightning impulse current (10/350) L+N-PE	Itotal 50 kA	50 kA	50 kA	50 kA
Lightning impulse current (10/350) L,N-PE	Iimp 25 kA	25 kA	25 kA	25 kA
Follow-on current extinguishing capability at Uc (50/60 Hz) I _{fi}	4 kA	4 kA	4 kA	4 kA
Short-circuit withstand capability at max. back-up fuse	I _k 50 kAeff	50 kAeff	50 kAeff	50 kAeff
Max. acceptable back-up fuse F2 (spur wiring)	250 A gL/gG	250 A gL/gG	250 A gL/gG	250 A gL/gG
Max. acceptable back-up fuse F1 (V wiring)	125 A gL/gG	125 A gL/gG	125 A gL/gG	125 A gL/gG
Operating temperature range	TU -40 - +85 °C	-40 - +85 °C	-40 - +85 °C	-40 - +85 °C
Max. conductor cross section	50mm ² stranded/35mm ² flexible	50mm ² stranded/35mm ² flexible	50mm ² stranded/35mm ² flexible	50mm ² stranded/35mm ² flexible
Recommended conductor cross section	25 mm ²	25 mm ²	25 mm ²	25 mm ²
Max. connection torque for terminals	4,5 Nm	4,5 Nm	4,5 Nm	4,5 Nm
Enclosure material / colour	polycarbonate (halogen free) UL 94-V0/yellow			

With remote signalling contact (FM)	PP BCD TN 25/50 /FM	PP BCD TN 25/50/FM-350	PP BCD TN 25/50/LED/FM	PP BCD TN 25/50/LED/FM-350
Article-No.	38 12 15	38 50 70	37 12 02	38 51 10
Switching capacity	250 V/2 A	250 V/2 A	250 V/2 A	250 V/2 A
Max. conductor cross section FM	1,5 mm ²	1,5 mm ²	1,5 mm ²	1,5 mm ²



				
Technical Data	PowerPro BCD-Tr/25kA	PP BCD-Tr/25kA-350	PP PCD-Tr/25kA-VA	PP BCD 25-350
Article-No.	37 38 50	37 38 52	37 38 51	37 38 88
EC category/EN type	Type 1 + 2 + 3 (class I+II+III)	Type 1 + 2 + 3 (class I+II+III)	Type 1 + 2 + 3 (class I+II+III)	Type 1 + 2 + 3 (class I+II+III)
Nominal voltage AC	UN 230 / 400 V~	230 / 400 - 240 / 415 V~	230/400 V~	230 / 400 - 240 / 415 V~
Max. continuous operating voltage AC	Uc min. 255 V~	350 V~	255 V~	350 V~
Insulation resistance	Risol >10 GΩ	>10 GΩ	> 10 GΩ	>10 GΩ
Protection level at 100% lightning imp. sparkover voltage (1.2/50μs)	Up ≤ 1 kV	≤ 1 kV	≤ 1,0 kV	≤ 1 kV
Voltage protection level at limp 50 kA	Up ≤ 1 kV	≤ 1 kV	≤ 1,0 kV	≤ 1 kV
Response time bei 1kV/μs	tA 50 ns	50 ns	50 ns	50 ns
Lightning impulse current (10/350) pro Pol	Iimp 25 kA	25 kA	25 kA	25 kA
Max. Impulsstoßstrom (8/20μs)	I _{max} 80 kA	k. A.	k. A.	k. A.
Follow-on current extinguishing capability at Uc (50/60 Hz) I _{fi}	17,5 kA	17,5 kA	17,5 kA	17,5 kA
Short-circuit withstand capability at max. back-up fuse 250 A gL	I _k 50 kAeff	50 kAeff	50 kAeff	50 kAeff
Max. acceptable back-up fuse F2 (spur wiring)	250 A gL/gG	250 A gL/gG	250 A gL/gG	250 A gL/gG
Max. acceptable back-up fuse F1 (V wiring)	125 A gL/gG	125 A gL/gG	125 A gL/gG	125 A gL/gG
Operating temperature range	TU -40 - +85 °C	-40 - +85 °C	-40 - +85 °C	-40 - +85 °C
Max. conductor cross section	50mm ² stranded/35mm ² flexible	50mm ² stranded/35mm ² flexible	50mm ² stranded/35mm ² flexible	50mm ² stranded/35mm ² flexible
Recommended conductor cross section	25 mm ²	25 mm ²	25 mm ²	25 mm ²
Enclosure material / colour	polycarbonate (halogen free) UL 94-V0/yellow			

With remote signalling contact (FM)	PowerPro BCD-Tr/25kA/PK	PP BCD-Tr/25kA/FM-350	PP PCD-Tr/25kA-VA/FM	PP BCD 25/FM-350
Article-No.	37 38 60	37 38 62	37 38 61	37 38 89
Switching capacity	250 V/2 A	250 V/2 A	250 V/2 A	250 V/2 A
Max. conductor cross section FM	1,5 mm ²	1,5 mm ²	1,5 mm ²	1,5 mm ²





SURGE PROTECTION FOR POWER SUPPLY SYSTEMS

AC POWER SUPPLY

			
Technical Data		PP BCD 27kA	PP BCD 27kA-350
Article-No.		37 38 55	37 38 58
EC category/EN type		Type 1 + 2 + 3 (class I+II+III)	Type 1 + 2 + 3 (class I+II+III)
Nominal voltage AC	UN	230 / 400 V~	230 / 400 V~
Max. continuous operating voltage AC	Uc	255 V~	350 V~
Insulation resistance	Risol	>10 GΩ	>10 GΩ
Protection level at 100% lightn. imp. sparkover voltage (1.2/50μs)	Up	≤ 1 kV	≤ 1 kV
Voltage protection level at limp 50 kA	Up	≤ 1 kV	≤ 1 kV
Response time bei 1kV/μs	tA	50 ns	50 ns
Lightning impulse current (10/350)	limp	27 kA	27 kA
Max. surge impulse discharge current (8/20μs)	Imax	-	-
Follow-on current extinguishing capability at Uc (50/60 Hz) I _{fi}		4.0 kA	4.0 kA
Short-circuit withstand capability at max. back-up fuse 250 A gL I _{sk}		25 kA _{eff}	25 kA _{eff}
Max. acceptable back-up fuse F2 (spur wiring)		250 A gL/gG	250 A gL/gG
Max. acceptable back-up fuse F1 (V wiring)		125 A gL/gG	125 A gL/gG
Operating temperature range	TU	-40 - +80 °C	-40 - +85 °C
Max. conductor cross section		50mm ² stranded/35mm ² flexible	50mm ² stranded/35mm ² flexible
Recommended conductor cross section		25 mm ²	25 mm ²
Enclosure material / colour		polycarbonate UL 94-V0/yellow	polycarbonate UL 94-V0/yellow

With remote signalling contact (FM)		PP BCD 27kA/FM	PP BCD 27kA/FM-350
Article-No.		37 38 65	37 38 68
Switching capacity		250 V/2 A	250 V/2 A
Max. conductor cross section FM		1,5 mm ²	1,5 mm ²

			
Technical Data		PP BCD TNC 75/LED	PP BCD TT 100/LED
Article-No.		37 39 56	37 39 58
Nominal voltage AC	UN	230/400 V~	230/400 V~
Max. continuous operating voltage AC	Uc	350 V~	255 V~
Insulation resistance	Risol	>10 GΩ	>10 GΩ
Protection level at 100% lightn. imp. sparkover voltage (1.2/50μs)	Up	≤ 1,0 kV	≤ 1,0 kV
Voltage protection level at limp L-N	Up	≤ 1,0 kV	≤ 1,0 kV
Response time	tA	<50 ns	<50 ns
Lightning impulse current (10/350) L1+L2+L3+N-PE	I _{total}	100 kA	75 kA
Lightning impulse current (10/350) L-N	limp	25 kA	25 kA
Lightning impulse current (10/350) N-PE	limp	100 kA	-
Follow-on current extinguishing capability at Uc (50/60 Hz) I _{fi}		4 kA	4,0 kA
Short-circuit withstand capability at max. back-up fuse 250 A gL I _{sk}		50 kA _{eff}	50 kA _{eff}
Max. acceptable back-up fuse F1 (V wiring)		125 A gL/gG	125 A gL/gG
Max. acceptable back-up fuse F2 (spur wiring)		250 A gL/gG	250 A gL/gG
Operating temperature range	TU	-40 - +80 °C	-40 - +80 °C
Max. conductor cross section		50mm ² stranded/35mm ² flexible	50mm ² stranded/35mm ² flexible
Recommended conductor cross section		25 mm ²	25 mm ²
Max. connection torque for terminals		4,5 Nm	4,5 Nm

With remote signalling contact (FM)		PP BCD TNC 75/LED/FM	PP BCD TT 100/LED/FM
Article-No.		37 39 57	37 39 59
Switching capacity		250 V/2 A	250 V/2 A
Max. conductor cross section FM		1,5 mm ²	1,5 mm ²





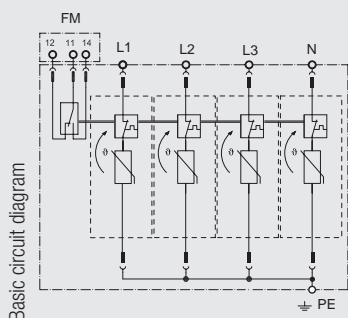

SPD Type 2 for AC power supplies / EL series

EL-T2

Pluggable SPD Type 2 (class II) for one and three phase systems. Prewired complete unit consisting of base part and modules. Variants available of 75 up to 750 V.



- Test standard: IEC 61643-1 / EN 61643-11
- Vibration and Shock according standard: DIN EN 60068-2-6 and DIN EN 60068-2-27
- Mounting on 35 mm DIN rail
- Optional remote changeover contact

				
Technical Data	EL-T2/4+0-130	EL-T2/4+0-275	EL-T2/4+0-350	EL-T2/4+0-440
Article-No.	38 81 08	38 81 09	38 81 10	38 81 11
EC category/EN type	Type 2 / class II	Type 2 / class II	Type 2 / class II	Type 2 / class II
Nominal voltage AC	UN 120 V~	230 V~	230 V~	230 V~
Max. continuous operating voltage AC	Uc 130 V~	275 V~	350 V~	440 V~
Nominal discharge current (8/20)	In 15 kA	20 kA	20 kA	20 kA
Max. impulse discharge current (8/20)	I _{max} 40 kA	40 kA	40 kA	40 kA
Protection level at In	Up ≤ 0,7 kV	≤ 1,2 kV	≤ 1,5 kV	≤ 2,0 kV
Protection level at 5kA	Up ≤ 0,5 kV	≤ 0,9 kV	≤ 1,0 kV	≤ 1,5 kV
Short-circuit withstand capability at max. back-up fuse	Ik 25 kAeff	25 kAeff	25 kAeff	25 kAeff
Max. allowed prefuse	125 A gL/gG	125 A gL/gG	125 A gL/gG	125 A gL/gG
Operating temperature range	TU -40 - +80 °C	-40 - +80 °C	-40 - +80 °C	-40 - +80 °C
Min. conductor cross section at terminals	1.5mm ² solid/flexible	1.5mm ² solid/flexible	1.5mm ² solid/flexible	1.5mm ² solid/flexible
Max. conductor cross section	35mm ² stranded/25mm ² flexible	35mm ² stranded/25mm ² flexible	35mm ² stranded/25mm ² flexible	35mm ² stranded/25mm ² flexible
Enclosure material / colour	thermoplastic, yellow, UL 97 V-0	thermoplastic, yellow, UL 97 V-0	thermoplastic, yellow, UL 97 V-0	thermoplastic, yellow, UL 97 V-0
Degree of protection (IEC EN 60529)	IP 20	IP 20	IP 20	IP 20
Dimension (DIN 43880)	4 TE	4 TE	4 TE	4 TE
Composed of: number of modules	4x 38 80 01	4x 38 80 02	4x 38 80 03	4x 38 80 04
Power supply system	3 phase TNS systems	3 phase TNS systems	3 phase TNS systems	3 phase TNS systems

With remote signalling contact (FM)	EL-T2/4+0-130-FM	EL-T2/4+0-275-FM	EL-T2/4+0-350-FM	EL-T2/4+0-440-FM
Article-No.	38 81 01	38 81 02	38 81 03	38 81 04
Max. operating voltage	250 V AC/125 V DC	250 V AC/125 V DC	250 V AC/125 V DC	250 V AC/125 V DC
Max. operating current	1 A AC/ 200 mA DC	1 A AC/ 200 mA DC	1 A AC/ 200 mA DC	1 A AC/ 200 mA DC









Accessories: Module	EL-T2-75-M	EL-T2-130-M	EL-T2-275-M	EL-T2-350-M	EL-T2-440-M	EL-T2-550-M	EL-T2-750-M	EL-T2-NPE-M
Article-No.	38 80 00	38 80 01	38 80 02	38 80 03	38 80 04	38 80 05	38 80 06	38 80 07

Dimension drawing, see pages 194 to 198









SURGE PROTECTION FOR POWER SUPPLY SYSTEMS

AC POWER SUPPLY

				
Technical Data	EL-T2/3+1-130	EL-T2/3+1-275	EL-T2/3+1-350	EL-T2/3+1-440
Article-No.	38 81 22	38 81 23	38 81 24	38 81 25
EC category/EN type	Type 2 / class II	Type 2 / class II	Type 2 / class II	Type 2 / class II
Nominal voltage AC	UN 120 V~	230 V~	230 V~	230 V~
Max. continuous operating voltage AC	Uc 130 V~	275 V~	350 V~	440 V~
Nominal discharge current (8/20)	In 15 kA	20 kA	20 kA	20 kA
Max. operating current	Imax 40 kA	40 kA	40 kA	40 kA
Protection level at In	Up ≤ 0,7 kV	≤ 1,2 kV	≤ 1,5 kV	≤ 2,0 kV
Protection level at 5kA	Up ≤ 0,5 kV	≤ 0,9 kV	≤ 1,0 kV	≤ 1,5 kV
Protection level N-PE	Up ≤ 1,5 kV	≤ 1,5 kV	≤ 1,5 kV	≤ 1,5 kV
Follow current quenching capacity AC N-PE	Ifi 100 Aeff	100 Aeff	100 Aeff	100 Aeff
Short-circuit withstand capability at max. back-up fuse	Ik 25 kAeff	25 kAeff	25 kAeff	25 kAeff
Max. allowed prefuse	125 A gL/gG	125 A gL/gG	125 A gL/gG	125 A gL/gG
Operating temperature range	TU -40 - +80 °C	-40 - +80 °C	-40 - +80 °C	-40 - +80 °C
Min. conductor cross section at terminals	1.5mm² solid/flexible	1.5mm² solid/flexible	1.5mm² solid/flexible	1.5mm² solid/flexible
Max. conductor cross section	35mm² stranded/25mm² flexible	35mm² stranded/25mm² flexible	35mm² stranded/25mm² flexible	35mm² stranded/25mm² flexible
Enclosure material / colour	thermoplastic, yellow, UL 97 V-0	thermoplastic, yellow, UL 97 V-0	thermoplastic, yellow, UL 97 V-0	thermoplastic, yellow, UL 97 V-0
Degree of protection (IEC EN 60529)	IP 20	IP 20	IP 20	IP 20
Dimension (DIN 43880)	4 TE	4 TE	4 TE	4 TE
Composed of: number of moduls	3x 38 80 01 + 1x 38 80 07	3x 38 80 02 + 1x 38 80 07	3x 38 80 03 + 1x 38 80 07	3x 38 80 04 + 1x 38 80 07
Power supply system	3 phase TNS/TT systems	3 phase TNS/TT systems	3 phase TNS/TT systems	3 phase TNS/TT systems
With remote signalling contact (FM)	EL-T2/3+1-130-FM	EL-T2/3+1-275-FM	EL-T2/3+1-350-FM	EL-T2/3+1-440-FM
Article-No.	38 81 15	38 81 16	38 81 17	38 81 18
Max. operating voltage	250 V AC/125 V DC	250 V AC/125 V DC	250 V AC/125 V DC	250 V AC/125 V DC
Max. operating current	1 A AC/ 200 mA DC	1 A AC/ 200 mA DC	1 A AC/ 200 mA DC	1 A AC/ 200 mA DC
				
Technical Data	EL-T2/3+0-130	EL-T2/3+0-275	EL-T2/3+0-350	EL-T2/3+0-440
Article-No.	38 81 36	38 81 37	38 81 38	38 81 39
EC category/EN type	Type 2 / class II	Type 2 / class II	Type 2 / class II	Type 2 / class II
Nominal voltage AC	UN 120 V~	230 V~	230 V~	230 V~
Max. continuous operating voltage AC	Uc 130 V~	275 V~	350 V~	440 V~
Nominal discharge current (8/20)	In 15 kA	20 kA	20 kA	20 kA
Max. impulse discharge current (8/20)	Imax 40 kA	40 kA	40 kA	40 kA
Protection level at In	Up ≤ 0,7 kV	≤ 1,2 kV	≤ 1,5 kV	≤ 2,0 kV
Protection level at 5kA	Up ≤ 0,5 kV	≤ 0,9 kV	≤ 1,0 kV	≤ 1,5 kV
Short-circuit withstand capability at max. back-up fuse	Ik 25 kAeff	25 kAeff	25 kAeff	25 kAeff
Max. allowed prefuse	125 A gL/gG	125 A gL/gG	125 A gL/gG	125 A gL/gG
Operating temperature range	TU -40 - +80 °C	-40 - +80 °C	-40 - +80 °C	-40 - +80 °C
Min. conductor cross section at terminals	1.5mm² solid/flexible	1.5mm² solid/flexible	1.5mm² solid/flexible	1.5mm² solid/flexible
Max. conductor cross section	35mm² stranded/25mm² flexible	35mm² stranded/25mm² flexible	35mm² stranded/25mm² flexible	35mm² stranded/25mm² flexible
Enclosure material / colour	thermoplastic, yellow, UL 97 V-0	thermoplastic, yellow, UL 97 V-0	thermoplastic, yellow, UL 97 V-0	thermoplastic, yellow, UL 97 V-0
Degree of protection (IEC EN 60529)	IP 20	IP 20	IP 20	IP 20
Dimension (DIN 43880)	3 TE	3 TE	3 TE	3 TE
Composed of: number of moduls	3x 38 80 01	3x 38 80 02	3x 38 80 03	3x 38 80 04
Power supply system	3 phase TNC systemse	3 phase TNC systemse	3 phase TNC systemse	3 phase TNC systemse
With remote signalling contact (FM)	EL-T2/3+0-130-FM	EL-T2/3+0-275-FM	EL-T2/3+0-350-FM	EL-T2/3+0-440-FM
Article-No.	38 81 29	38 81 30	38 81 31	38 81 32
Max. operating voltage	250 V AC/125 V DC	250 V AC/125 V DC	250 V AC/125 V DC	250 V AC/125 V DC
Max. operating current	1 A AC/ 200 mA DC	1 A AC/ 200 mA DC	1 A AC/ 200 mA DC	1 A AC/ 200 mA DC











				
Technical Data	EL-T2/2+1-75	EL-T2/2+1-130	EL-T2/2+1-275	EL-T2/2+1-350
Article-No.	38 81 49	38 81 50	38 81 51	38 81 52
EC category/EN type	Type 2 / class II	Type 2 / class II	Type 2 / class II	Type 2 / class II
Nominal voltage AC	UN 60 V~	120 V~	230 V~	230 V~
Max. continuous operating voltage AC	Uc 75 V~	130 V~	275 V~	350 V~
Nominal discharge current (8/20)	In 10 kA	15 kA	20 kA	20 kA
Max. operating current	Imax 25 kA	40 kA	40 kA	40 kA
Protection level at In	Up ≤ 0,4 kV	≤ 0,7 kV	≤ 1,2 kV	≤ 1,5 kV
Protection level at 5kA	Up ≤ 0,33 kV	≤ 0,5 kV	≤ 0,9 kV	≤ 1,0 kV
Protection level N-PE	Up ≤ 1,5 kV	≤ 1,5 kV	≤ 1,5 kV	≤ 1,5 kV
Short-circuit withstand capability at max. back-up fuse	Ik 25 kAeff	25 kAeff	25 kAeff	25 kAeff
Max. allowed prefuse	125 A gL/gG	125 A gL/gG	125 A gL/gG	125 A gL/gG
Operating temperature range	TU -40 - +80 °C	-40 - +80 °C	-40 - +80 °C	-40 - +80 °C
Min. conductor cross section at terminals	1.5mm ² solid/flexible	1.5mm ² solid/flexible	1.5mm ² solid/flexible	1.5mm ² solid/flexible
Max. conductor cross section	35mm ² stranded/25mm ² flexible	35mm ² stranded/25mm ² flexible	35mm ² stranded/25mm ² flexible	35mm ² stranded/25mm ² flexible
Enclosure material / colour	thermoplastic, yellow, UL 97 V-0	thermoplastic, yellow, UL 97 V-0	thermoplastic, yellow, UL 97 V-0	thermoplastic, yellow, UL 97 V-0
Degree of protection (IEC EN 60529)	IP 20	IP 20	IP 20	IP 20
Dimension (DIN 43880)	3 TE	3 TE	3 TE	3 TE
Composed of: number of moduls	2x 38 80 00 + 1x 38 80 07	2x 38 80 01 + 1x 38 80 07	2x 38 80 02 + 1x 38 80 07	2x 38 80 03 + 1x 38 80 07
Power supply system	2 pole TT systems	2 pole TT systems	2 pole TT systems	2 pole TT systems
With remote signalling contact (FM)	EL-T2/2+1-75-FM	EL-T2/2+1-130-FM	EL-T2/2+1-275-FM	EL-T2/2+1-350-FM
Article-No.	38 81 42	38 81 43	38 81 44	38 81 45
Max. operating voltage	250 V AC/125 V DC	250 V AC/125 V DC	250 V AC/125 V DC	250 V AC/125 V DC
Max. operating current	1 A AC/ 200 mA DC	1 A AC/ 200 mA DC	1 A AC/ 200 mA DC	1 A AC/ 200 mA DC
				
Technical Data	EL-T2/2+1-440	EL-T2/2+1-550	EL-T2/2+1-750	
Article-No.	38 81 53	38 81 54	38 81 55	
EC category/EN type	Type 2 / class II	Type 2 / class II	Type 2 / class II	
Nominal voltage AC	UN 230 V~	400 V~	400 V~	
Max. continuous operating voltage AC	Uc 440 V~	550 V~	750 V~	
Nominal discharge current (8/20)	In 20 kA	20 kA	20 kA	
Max. operating current	Imax 40 kA	40 kA	40 kA	
Protection level at In	Up ≤ 2,0 kV	≤ 2,5 kV	≤ 3,0 kV	
Protection level at 5kA	Up ≤ 1,5 kV	≤ 1,8 kV	≤ 2,5 kV	
Protection level N-PE	Up ≤ 1,5 kV	≤ 1,5 kV	≤ 1,5 kV	
Short-circuit withstand capability at max. back-up fuse	Ik 25 kAeff	25 kAeff	25 kAeff	
Max. allowed prefuse	125 A gL/gG	125 A gL/gG	125 A gL/gG	
Operating temperature range	TU -40 - +80 °C	-40 - +80 °C	-40 - +80 °C	
Min. conductor cross section at terminals	1.5mm ² solid/flexible	1.5mm ² solid/flexible	1.5mm ² solid/flexible	
Max. conductor cross section	35mm ² stranded/25mm ² flexible	35mm ² stranded/25mm ² flexible	35mm ² stranded/25mm ² flexible	
Enclosure material / colour	thermoplastic, yellow, UL 97 V-0	thermoplastic, yellow, UL 97 V-0	thermoplastic, yellow, UL 97 V-0	
Degree of protection (IEC EN 60529)	IP 20	IP 20	IP 20	
Dimension (DIN 43880)	3 TE	3 TE	3 TE	
Composed of: number of moduls	2x 38 80 04 + 1x 38 80 07	2x 38 80 05 + 1x 38 80 07	2x 38 80 06 + 1x 38 80 07	
Power supply system	2 pole TT systems	2 pole TT systems	2 pole TT systems	
With remote signalling contact (FM)	EL-T2/2+1-440-FM	EL-T2/2+1-550-FM	EL-T2/2+1-750-FM	
Article-No.	38 81 46	38 81 47	38 81 48	
Max. operating voltage	250 V AC/125 V DC	250 V AC/125 V DC	250 V AC/125 V DC	
Max. operating current	1 A AC/ 200 mA DC	1 A AC/ 200 mA DC	1 A AC/ 200 mA DC	







SURGE PROTECTION FOR POWER SUPPLY SYSTEMS

AC POWER SUPPLY

				
Technical Data	EL-T2/2+0-130	EL-T2/2+0-275	EL-T2/2+0-350	EL-T2/2+0-440
Article-No.	38 81 64	38 81 65	38 81 66	38 81 67
EC category/EN type	Type 2 / class II	Type 2 / class II	Type 2 / class II	Type 2 / class II
Nominal voltage AC	UN 120 V~	230 V~	230 V~	230 V~
Max. continuous operating voltage AC	Uc 130 V~	275 V~	350 V~	440 V~
Nominal discharge current (8/20)	In 15 kA	20 kA	20 kA	20 kA
Max. operating current	Imax 40 kA	40 kA	40 kA	40 kA
Protection level at In	Up ≤ 0,7 kV	≤ 1,2 kV	≤ 1,5 kV	≤ 2,0 kV
Protection level at 5kA	Up ≤ 0,5 kV	≤ 0,9 kV	≤ 1,0 kV	≤ 1,5 kV
Short-circuit withstand capability at max. back-up fuse	Ik 25 kAeff	25 kAeff	25 kAeff	25 kAeff
Max. allowed prefuse	125 A gL/gG	125 A gL/gG	125 A gL/gG	125 A gL/gG
Operating temperature range	TU -40 - +80 °C	-40 - +80 °C	-40 - +80 °C	-40 - +80 °C
Min. conductor cross section at terminals	1.5mm ² solid/flexible	1.5mm ² solid/flexible	1.5mm ² solid/flexible	1.5mm ² solid/flexible
Max. conductor cross section	35mm ² stranded/25mm ² flexible	35mm ² stranded/25mm ² flexible	35mm ² stranded/25mm ² flexible	35mm ² stranded/25mm ² flexible
Enclosure material / colour	thermoplastic, yellow, UL 97 V-0	thermoplastic, yellow, UL 97 V-0	thermoplastic, yellow, UL 97 V-0	thermoplastic, yellow, UL 97 V-0
Degree of protection (IEC EN 60529)	IP 20	IP 20	IP 20	IP 20
Dimension (DIN 43880)	2 TE	2 TE	2 TE	2 TE
Composed of: number of moduls	2x 38 80 01	2x 38 80 02	2x 38 80 03	2x 38 80 04
Power supply system	1 phase TN systems	1 phase TN systems	1 phase TN systems	1 phase TN systems
With remote signalling contact (FM)	EL-T2/2+0-130-FM	EL-T2/2+0-275-FM	EL-T2/2+0-350-FM	EL-T2/2+0-440-FM
Article-No.	38 81 57	38 81 58	38 81 59	38 81 60
Max. operating voltage	250 V AC/125 V DC	250 V AC/125 V DC	250 V AC/125 V DC	250 V AC/125 V DC
Max. operating current	1 A AC/ 200 mA DC	1 A AC/ 200 mA DC	1 A AC/ 200 mA DC	1 A AC/ 200 mA DC
				
Technical Data	EL-T2/1+1-130	EL-T2/1+1-275	EL-T2/1+1-350	EL-T2/1+1-440
Article-No.	38 81 78	38 81 79	38 81 80	38 81 81
EC category/EN type	Type 2 / class II	Type 2 / class II	Type 2 / class II	Type 2 / class II
Nominal voltage AC	UN 120 V~	230 V~	230 V~	230 V~
Max. continuous operating voltage AC	Uc 130 V~	275 V~	350 V~	440 V~
Nominal discharge current (8/20)	In 15 kA	20 kA	20 kA	20 kA
Max. operating current	Imax 40 kA	40 kA	40 kA	40 kA
Protection level at In	Up ≤ 0,7 kV	≤ 1,2 kV	≤ 1,5 kV	≤ 2,0 kV
Protection level at 5kA	Up ≤ 0,5 kV	≤ 0,9 kV	≤ 1,0 kV	≤ 1,5 kV
Protection level N-PE	Up ≤ 1,5 kV	≤ 1,5 kV	≤ 1,5 kV	≤ 1,5 kV
Follow current quenching capacity AC N-PE	Ifi 100 Aeff	100 Aeff	100 Aeff	100 Aeff
Short-circuit withstand capability at max. back-up fuse	Ik 25 kAeff	25 kAeff	25 kAeff	25 kAeff
Max. allowed prefuse	125 A gL/gG	125 A gL/gG	125 A gL/gG	125 A gL/gG
Operating temperature range	TU -40 - +80 °C	-40 - +80 °C	-40 - +80 °C	-40 - +80 °C
Min. conductor cross section at terminals	1.5mm ² solid/flexible	1.5mm ² solid/flexible	1.5mm ² solid/flexible	1.5mm ² solid/flexible
Max. conductor cross section	35mm ² stranded/25mm ² flexible	35mm ² stranded/25mm ² flexible	35mm ² stranded/25mm ² flexible	35mm ² stranded/25mm ² flexible
Enclosure material / colour	thermoplastic, yellow, UL 97 V-0	thermoplastic, yellow, UL 97 V-0	thermoplastic, yellow, UL 97 V-0	thermoplastic, yellow, UL 97 V-0
Degree of protection (IEC EN 60529)	IP 20	IP 20	IP 20	IP 20
Dimension (DIN 43880)	2 TE	2 TE	2 TE	2 TE
Composed of: number of moduls	1x 38 80 01 + 1x 38 80 07	1x 38 80 02 + 1x 38 80 07	1x 38 80 03 + 1x 38 80 07	1x 38 80 04 + 1x 38 80 07
Power supply system	1 phase TT and TN systems	1 phase TT and TN systems	1 phase TT and TN systems	1 phase TT and TN systems
With remote signalling contact (FM)	EL-T2/1+1-130-FM	EL-T2/1+1-275-FM	EL-T2/1+1-350-FM	EL-T2/1+1-440-FM
Article-No.	38 81 71	38 81 72	38 81 73	38 81 74
Max. operating voltage	250 V AC/125 V DC	250 V AC/125 V DC	250 V AC/125 V DC	250 V AC/125 V DC
Max. operating current	1 A AC/ 200 mA DC	1 A AC/ 200 mA DC	1 A AC/ 200 mA DC	1 A AC/ 200 mA DC



				
Technical Data	EL-T2/1+0-75	EL-T2/1+0-130	EL-T2/1+0-275	EL-T2/1+0-350
Article-No.	38 81 91	38 81 92	38 81 93	38 81 94
EC category/EN type	Type 2 / class II	Type 2 / class II	Type 2 / class II	Type 2 / class II
Nominal voltage AC	UN 60 V~	120 V~	230 V~	230 V~
Max. continuous operating voltage AC	Uc 75 V~	130 V~	275 V~	350 V~
Nominal discharge current (8/20)	In 10 kA	15 kA	20 kA	20 kA
Max. operating current	Imax 25 kA	40 kA	40 kA	40 kA
Protection level at In	Up ≤ 0,4 kV	≤ 0,7 kV	≤ 1,2 kV	≤ 1,5 kV
Protection level at 5kA	Up ≤ 0,33 kV	≤ 0,5 kV	≤ 0,9 kV	≤ 1,0 kV
Short-circuit withstand capability at max. back-up fuse	Ik 25 kAeff	25 kAeff	25 kAeff	25 kAeff
Max. allowed prefuse	125 A gL/gG	125 A gL/gG	125 A gL/gG	125 A gL/gG
Operating temperature range	TU -40 - +80 °C	-40 - +80 °C	-40 - +80 °C	-40 - +80 °C
Min. conductor cross section at terminals	1.5mm ² solid/flexible	1.5mm ² solid/flexible	1.5mm ² solid/flexible	1.5mm ² solid/flexible
Max. conductor cross section	35mm ² stranded/25mm ² flexible	35mm ² stranded/25mm ² flexible	35mm ² stranded/25mm ² flexible	35mm ² stranded/25mm ² flexible
Enclosure material / colour	thermoplastic, yellow, UL 97 V-0	thermoplastic, yellow, UL 97 V-0	thermoplastic, yellow, UL 97 V-0	thermoplastic, yellow, UL 97 V-0
Degree of protection (IEC EN 60529)	IP 20	IP 20	IP 20	IP 20
Dimension (DIN 43880)	1 TE	1 TE	1 TE	1 TE
Composed of: number of moduls	1x 38 80 00	1x 38 80 01	1x 38 80 02	1x 38 80 03
Power supply system	between L-N	between L-N	between L-N	between L-N

With remote signalling contact (FM)	EL-T2/1+0-75-FM	EL-T2/1+0-130-FM	EL-T2/1+0-275-FM	EL-T2/1+0-350-FM
Article-No.	38 81 84	38 81 85	38 81 86	38 81 87
Max. operating voltage	250 V AC/125 V DC	250 V AC/125 V DC	250 V AC/125 V DC	250 V AC/125 V DC
Max. operating current	1 A AC/ 200 mA DC	1 A AC/ 200 mA DC	1 A AC/ 200 mA DC	1 A AC/ 200 mA DC

			
Technical Data	EL-T2/1+0-440	EL-T2/1+0-550	EL-T2/0+1-NPE
Article-No.	38 81 95	38 81 96	38 81 98
EC category/EN type	Type 2 / class II	Type 2 / class II	Type 2 / class II
Nominal voltage AC	UN 230 V~	400 V~	230 V~
Max. continuous operating voltage AC	Uc 440 V~	550 V~	260 V~
Nominal discharge current (8/20)	In 20 kA	20 kA	20 kA
Max. operating current	Imax 40 kA	40 kA	40 kA
Protection level at In	Up ≤ 2,0 kV	≤ 2,5 kV	≤ 1,5 kV
Protection level at 5kA	Up ≤ 1,5 kV	≤ 1,8 kV	100 Aeff
Short-circuit withstand capability at max. back-up fuse	Ik 25 kAeff	25 kAeff	25 kAeff
Max. allowed prefuse	125 A gL/gG	125 A gL/gG	125 A gL/gG
Operating temperature range	TU -40 - +80 °C	-40 - +80 °C	-40 - +80 °C
Min. conductor cross section at terminals	1.5mm ² solid/flexible	1.5mm ² solid/flexible	1.5mm ² solid/flexible
Max. conductor cross section	35mm ² stranded/25mm ² flexible	35mm ² stranded/25mm ² flexible	35mm ² stranded/25mm ² flexible
Enclosure material / colour	thermoplastic, yellow, UL 97 V-0	thermoplastic, yellow, UL 97 V-0	thermoplastic, yellow, UL 97 V-0
Degree of protection (IEC EN 60529)	IP 20	IP 20	IP 20
Dimension (DIN 43880)	1 TE	1 TE	1 TE
Composed of: number of moduls	1x 38 80 04	1x 38 80 05	1x 38 80 07
Power supply system	between L-N	between L-N	between L-N

With remote signalling contact (FM)	EL-T2/1+0-440-FM	EL-T2/1+0-550-FM	
Article-No.	38 81 88	38 81 89	
Max. operating voltage	250 V AC/125 V DC	250 V AC/125 V DC	
Max. operating current	1 A AC/ 200 mA DC	1 A AC/ 200 mA DC	



SPD Type 2 for AC power supplies / EnerPro C



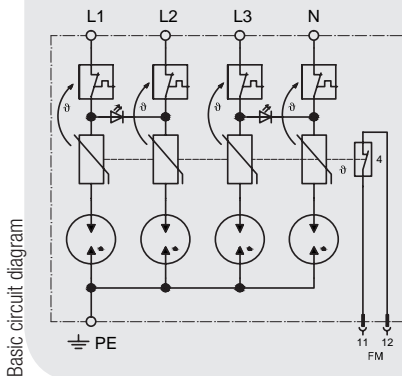

EnerPro C

Compact housing, no contact problems with plug-in connections. SPD Type 2 (class II), leakage current free for one and three phase systems. Available for all net systems.







Basic circuit diagram

- Monitoring of conductor and arrester (LED)
- Up to four pole prewired modular units
- Optional remote signalling contact (FM)

				
Technical Data	EP C TNS 275	EP C TNS 350	EP C TNC 275	EP C TNC 350
Article-No.	38 11 78	38 55 80	38 11 76	38 55 60
Nominal voltage AC	UN 230/400 V~	350 V~	230/400 V~	350 V~
Max. continuous operating voltage AC	Uc 275/480 V~	275/480 V~	275/480 V~	275/480 V~
Protection level at 5kA	Up ≤ 1,0 kV	≤ 1,3 kV	≤ 1,0 kV	≤ 1,3 kV
Protection level at In (8/20)	Up ≤ 1,4 kV	≤ 1,75 kV	≤ 1,4 kV	≤ 1,75 kV
Response time	tA <25 ns	<25 ns	<25 ns	<25 ns
Nominal discharge current (8/20)	In 15 kA	15 kA	15 kA	15 kA
Max. operating current	Imax 40 kA	40 kA	40 kA	40 kA
Max. acceptable fuse or back-up fuse	125 A gL/gG	125 A gL/gG	125 A gL/gG	125 A gL/gG
Operating temperature range	TU -40 - +80 °C	-40 - +80 °C	-40 - +80 °C	-40 - +80 °C
Max. conductor cross section	stranded 35/fine stranded 25 mm ²			
Recommended conductor cross section	16 mm ²	16 mm ²	16 mm ²	16 mm ²
Max. connection torque for terminals	4,5 Nm	4,5 Nm	4,5 Nm	4,5 Nm
Enclosure material / colour	polycarbonate (halogen-free) UL 94-V0 / yellow			
Degree of protection (IEC EN 60529)	IP 20	IP 20	IP 20	IP 20
Mounting on	35 mm DIN rail (DIN EN 50 022)			

With remote signalling contact (FM)	EP C TNS 275/FM	EP C TNS 350/FM	EP C TNC 275/FM	EP C TNC 350/FM
Article-No.	38 11 79	38 55 90	38 11 77	38 55 70
Switching capacity	250 V/2 A	250 V/2 A	250 V/2 A	250 V/2 A
Remote signalling contact	break contact	break contact	break contact	break contact



				
Technical Data	EP C TT 275	EP C TT 350	EP C TT1+1 275	EP C TT1+1 350
Article-No.	38 11 80	38 56 00	38 11 82	38 11 88
Nominal voltage AC	UN 230/400 V~	230/400 (240/415) V~	230/400 V~	230/400 (240/415) V~
Max. continuous operating voltage AC	Uc 275/480 V~	350 V~	275/480 V~	350 V~
Protection level at 5kA	Up ≤ 1,0 kV	≤ 1,0 kV	≤ 1,0 kV	≤ 1,0 kV
Protection level at In	Up ≤ 1,4 kV	≤ 1,4 kV	≤ 1,4 kV	≤ 1,4 kV
Response time	tA <25 ns	< 50 ns	<25 ns	< 50 ns
Nominal discharge current (8/20µs) Ader-Erde	In 15 kA	15 kA	15 kA	15 kA
Critical discharge current (8/20 µs)	Imax 40 kA	40 kA	40 kA	40 kA
Max. acceptable fuse or back-up fuse	125 A gL/gG	125 A gL/gG	125 A gL/gG	125 A gL/gG
Operating temperature range	TU -40 - +80 °C	-40 - +80 °C	-40 - +80 °C	-40 - +80 °C
Max. conductor cross section	stranded 35/fine stranded 25 mm ²			
Recommended conductor cross section	16 mm ²	16 mm ²	16 mm ²	16 mm ²
Max. connection torque for terminals	4,5 Nm	4,5 Nm	4,5 Nm	4,5 Nm
Enclosure material / colour	polycarbonate (halogen-free) UL 94-V0 / yellow			
Degree of protection (IEC EN 60529)	IP 20	IP 20	IP 20	IP 20
Mounting on	35 mm DIN rail (DIN EN 50 022)			

With remote signalling contact (FM)	EP C TT 275/FM	EP C TT 350/FM	EP C TT1+1 275/FM	EP C TT1+1 350/FM
Article-No.	38 11 81	38 56 10	38 11 83	38 11 91
Switching capacity	250 V/2 A	250 V/2 A	250 V/2 A	250 V/2 A
Remote signalling contact	break contact	break contact	break contact	break contact

	
Technical Data	EP C TT2+1 110
Article-No.	38 09 10
Nominal voltage AC	UN 100/110 V~
Max. continuous operating voltage AC	Uc 130 V~
Protection level at 5kA	Up ≤ 1.3 kV (PE-N) / ≤ 0.7 kV (L1,L2-N)
Protection level at In	Up ≤ 1.5 kV (PE-N) / ≤ 1.0 kV (L1,L2-N)
Response time	tA < 25 ns
Nominal discharge current (8/20µs)	In 20 kA (PE-N) / 15 kA (L1,L2-N)
Max. discharge current (8/20 µs)	Imax 40 kA (L1,L2-N)
Max. acceptable fuse or back-up fuse	125 A gL/gG
Operating temperature range	TU -40 - +80 °C
Max. conductor cross section	stranded 35/fine stranded 25 mm ²
Recommended conductor cross section	25 mm ²
Max. connection torque for terminals	4,5 Nm
Enclosure material / colour	polycarbonate (halogen-free) UL 94-V0 / yellow
Degree of protection (IEC EN 60529)	IP 20
Mounting on	35 mm DIN rail (DIN EN 50 022)





With remote signalling contact (FM)	EP C TT2+1 110/FM
Article-No.	38 09 11
Switching capacity	250 V/0.5 A
Remote signalling contact	break contact

Dimension drawing, see pages 194 to 198



SURGE PROTECTION FOR POWER SUPPLY SYSTEMS

AC POWER SUPPLY

					
Technical Data		EP C TN 75	EP C TN 275	EP C TN 350	EP C TN 275-D
Article-No.		38 14 00	38 12 47	38 55 40	38 12 52
Nominal voltage AC	UN	60 V~	230/400 V~	350 V~	230 V~
Max. continuous operating voltage AC	Uc	75 V~	275/480 V~	275/480 V~	275 V~
Protection level at 5kA	Up	≤ 0,3 kV	≤ 1,0 kV	≤ 1,3 kV	≤ 1,0 kV
Protection level at In (8/20)	Up	≤ 0,55 kV	≤ 1,4 kV	≤ 1,75 kV	≤ 1,4 kV
Response time	tA	<50 ns	<25 ns	<25 ns	< 50 ns
Nominal discharge current (8/20)	In	15 kA	15 kA	15 kA	15 kA
Max. operating current	Imax	40 kA	40 kA	40 kA	40 kA
Max. acceptable fuse or back-up fuse		125 A gL/gG	125 A gL/gG	125 A gL/gG	125 A gL/gG
Operating temperature range	TU	-40 - +80 °C	-40 - +80 °C	-40 - +80 °C	-40 - +80 °C
Max. conductor cross section		stranded 35/fine stranded 25 mm ²			
Recommended conductor cross section		16 mm ²	16 mm ²	16 mm ²	16 mm ²
Max. connection torque for terminals		4,5 Nm	4,5 Nm	4,5 Nm	4,5 Nm
Enclosure material / colour		polycarbonate (halogen-free) UL 94-V0 / yellow			
Degree of protection (IEC EN 60529)		IP 20	IP 20	IP 20	IP 20
Mounting on		35 mm DIN rail (DIN EN 50 022)			

With remote signalling contact (FM)	EP C TN 75/FM	EP C TN 275/FM	EP C TN 350
Article-No.	38 14 05	38 12 48	38 55 50
Switching capacity	250 V/2 A	250 V/2 A	250 V/2 A
Remote signalling contact	break contact	break contact	break contact

EnerPro 280Tr

Slim and leakage-current free 2-pole surge arrester, e.g. for a 1-phase TN system. Only 1 MW according to DIN 43880.

- Leakage current free
- Optional mit remote signalling contact (PK)
- Monitoring of conductor and arrester

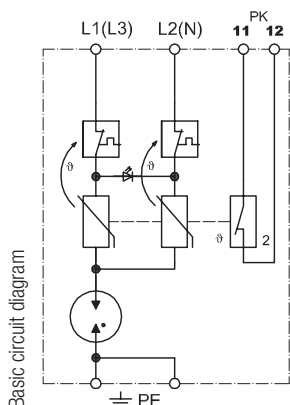

Technical Data	EnerPro 280Tr	
Article-No.	UN	38 20 28
Nominal voltage AC	230 /400 V~	
Max. continuous operating voltage AC (50/60Hz)	Uc	275/480 V~
Max. acceptable fuse or back-up fuse		125 A gL/gG
Protection level at 5 kA	Up	≤ 1,0 kV
Protection level at In L(N)-PE	Up	≤ 1,4 kV
Response time		≤ 50 ns
Nominal discharge current (8/20μs) L(N)-PE	In	15 kA
Critical discharge current (8/20 μs)	Imax	18 kA
Operating temperature range	TU	-40 - +80 °C
Max. conductor cross section		2.5mm ² solid or 1.5mm ² flexible
Recommended conductor cross section		1,5 / 2,5 mm ²
Enclosure material / colour		polycarbonate UL 94-V0/yellow

With Remote signalling contact	EnerPro 280Tr/Pk	
Article-No.	UN	38 20 29
Switching capacity		250 V/2 A
Remote signalling contact		break contact

Dimension drawing, see pages 194 to 198





SPD Type 2 for AC power supplies / EnerPro C

EnerPro C IT 2P/3P

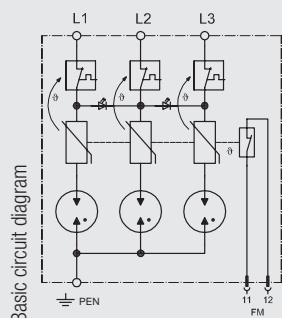
Surge Protective Device Type 2, class II



- Monitoring of conductor and arrester via LED
- Leakage current-free

		
Technical Data	EP C IT 2P 440	EP C IT 3P 440
Article-No.	38 15 00	38 15 10
IEC category/EN type	Type 2 / class II	Type 2 / class II
Nominal voltage	UN 230 V	230 V
Max. continuous operating voltage AC	Uc 440 V~	440 V~
Protection level at 5 kA	Up ≤ 1.5 kV	≤ 1.5 kV
Protection level at In (8/20)	Up ≤ 2.2 kV	≤ 2.2 kV
Response time	tA < 25 ns	< 25 ns
Nominal impulse discharge current (10 x 8/20)	In 15 kA	15 kA
Max. impulse discharge current (8/20)	Imax 30 kA	30 kA
Max. acceptable fuse or back-up fuse	125 A gL/gG	125 A gL/gG
Operating temperature range	TU -40 - +80 °C	-40 - +80 °C
Max. conductor cross section	35mm ² stranded/25mm ² flexible	35mm ² stranded/25mm ² flexible
Recommended conductor cross section	25 mm ²	16 mm ²
Max. connection torque for terminals	4.5 Nm	4.5 Nm
Enclosure material / colour	polycarbonate (halogen-free) UL 94-V0 / yellow	
Degree of protection (IEC EN 60529)	IP 20	IP 20
Mounting on	35 mm DIN rail (DIN EN 50 022)	35 mm DIN rail (DIN EN 50 022)
With remote signalling contact (FM)	EP C IT 2P 440/FM	EP C IT 3P 440/FM
Article-No.	38 15 01	38 15 11
Switching capacity	250 V/2 A	250 V/2 A
Remote signalling contact	break contact	break contact

Dimension drawing, see pages 194 to 198



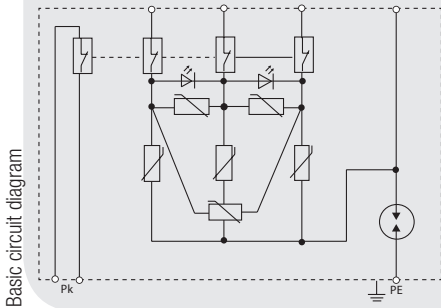

SPD Type 2 for AC power supplies / EnerPro C

EnerPro 282Tr-M and 284Tr-M



- SPD based on NPE isolating spark gap technology for TT systems
- No blow-out vents, thus, not requiring any safety clearance to other installations
- Leakage current-free
- Optical function control display by LED
- Optional potential-free remote signalling contact (PK)

		
Technical Data	EnerPro 282Tr-M	EnerPro 284Tr-M
Article-No.	38 20 44	38 20 42
IEC category/EN type	Type 2 / class II	Type 2 / class II
Max. continuous operating voltage AC	Uc 230 / 400 V~	230 / 400 V~
Max. continuous operating voltage DC	Uc 275 / 480 V	≤ 275 V
Response time 10 kV/μs	tA < 5 ns	< 5 ns
Protection level at 1kV/μs (L(N)-PE)	Uas < 1,4 kV	≤ 1,4 (N/PE ≤ 1,5) kV
Protection level at In [L(N)-PE] (Urest)	Ures < 1,4 kV	-
Nominal discharge current L-PE (8/20 μs)	10x 15 kA	10x 15 kA
Nominal discharge current (8/20)	In 1 x 40 kA	1 x 40 kA
Service life test current (10/700μs)	IL 500x 100, 10x 500, 1x 40 A	-
Lightning impulse current N-PE (10/350 μs)	12 kA	12 kA
Max. acceptable fuse or back-up fuse	125 A gL/gG	125 A gL/gG
Operating temperature range	TU -40 - +80 °C	-40 - +80 °C
Max. conductor cross section	stranded 35/fine stranded 25	stranded 35/fine stranded 25
Max. connection torque for terminals	4,5 Nm	4,5 Nm
Enclosure material / colour	polycarbonate (halogen-free) UL 94-V0 / yellow	
Degree of protection (IEC EN 60529)	IP 20	IP 20
Mounting on	35 mm DIN rail (DIN EN 50 022)	35 mm DIN rail (DIN EN 50 022)
Insulation resistance	Risol -	≥ 10 GΩ
DC spark-over voltage	Uag	≥ 500 V=

With remote signalling contact (FM)	EnerPro 282Tr-M/Pk	EnerPro 284Tr-M/Pk
Article-No.	38 20 45	38 20 43
Switching capacity	250 V/2 A	250 V/2 A
Remote signalling contact	break contact	break contact

Dimension drawing, see pages 194 to 198





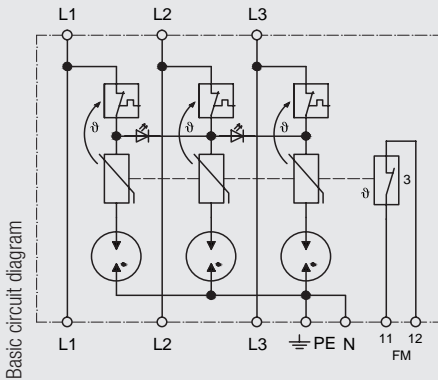

SPD Type 3 for AC power supplies / EnerPro D

EnerPro D

Multipol compact surge protective device Type 3 (class III) to protect one and three phase terminals of electronic of industries. The SPD is applicable at the transition 2-3 according to the lightning protection zones concept.



- No leakage currents to earth connection PE
- Line function and equipment control by LED/ Monitoring of conductor and arrester via LED
- Possible with parallel or spur wiring for 16 A
- Deepest protection against longitudinal and transverse voltages for loads up to 16 A
- Optional remote signalling contact (FM)

				
Technical Data	EP D TNC 275	EP D TNS 275	EP D TT 275	EP D TT1+1 275
Article-No.	38 05 24	38 05 30	38 05 35	38 05 38
Nominal voltage AC	UN 230 V~	230 V~	230 V~	230 V~
Max. continuous operating voltage AC	Uc 275 V~	275 V~	275 V~	275 V~
Rated load current	IL 16 A	16 A	16 A	16 A
Protection level L-N	Up ≤ 1,0 kV	≤ 1,0 kV	≤ 1,0 kV	≤ 1,0 kV
Protection level L/N-PE	Up ≤ 1,5 kV	≤ 1,5 kV	≤ 1,5 kV	≤ 1,5 kV
Combined surge	Uoc ≤ 4 kV	≤ 4 kV	≤ 4 kV	≤ 4 kV
Nominal discharge current (8/20)	In 5 kA	5 kA	5 kA	5 kA
Max. operating current	Imax 8 kA	8 kA	8 kA	8 kA
Response time L-N/L,N-PE	≤ 25/≤ 50 ns	≤ 25/≤ 50 ns	≤ 25/≤ 50 ns	≤ 25/≤ 50 ns
Max. acceptable fuse or back-up fuse	16 A gL/gG	16 A gL/gG	16 A gL/gG	16 A gL/gG
Max. conductor cross section	2.5 mm ² single-wire / 1.5 mm ² flexible with sleeve mm ²			
Operating temperature range	TU -40 - +80 °C	-40 - +80 °C	-40 - +80 °C	-40 - +80 °C
Enclosure material / colour	polycarbonate (halogen-free) UL 94-V0 / yellow			
Degree of protection (IEC EN 60529)	IP 20	IP 20	IP 20	IP 20
Dimension (DIN 43880)	2TE	2TE	2TE	1TE
Mounting on	35 mm DIN rail (DIN EN 50 022)			



With remote signalling contact (FM)	EP D TNC 275/FM	EP D TNS 275/FM	EP D TT 275/FM	EP D TT1+1 275/FM
Article-No.	38 05 25	38 05 31	38 05 36	38 05 39
Switching capacity	250 V/2 A	250 V/2 A	250 V/2 A	250 V/2 A
Remote signalling contact	break contact	break contact	break contact	break contact

Dimension drawing, see pages 194 to 198



SURGE PROTECTION FOR POWER SUPPLY SYSTEMS

AC POWER SUPPLY

				
Technical Data		EP D TT2+1 275	EP D IT 2P	EP D IT 3P
Article-No.		38 05 40	38 05 70	38 05 76
Nominal voltage AC	UN	230 V~	230 V~	230 V~
Max. continuous operating voltage AC	Uc	275 V~	440 V ~	440 V ~
Rated load current	IL	16 A	-	-
Protection level L-N	Up	≤ 1,0 kV	≤ 1,5 kV	≤ 1,5 kV
Protection level L/N-PE	Up	≤ 1,5 kV	≤ 1,5 kV	≤ 1,5 kV
Combined surge	Uoc	≤ 4 kV	≤ 4 kV	≤ 4 kV
Nominal discharge current (8/20)	In	5 kA	5 kA	5 kA
Max. operating current	Imax	8 kA	8 kA	8 kA
Response time L-N/L,N-PE		≤ 25/≤ 50 ns	≤ 25/≤ 50 ns	≤ 25/≤ 50 ns
Max. acceptable fuse or back-up fuse		16 A gL/gG	16 A gL/gG	16 A gL/gG
Max. conductor cross section		2.5 mm ² single-wire / 1.5 mm ² flexible with sleeve mm ²		
Operating temperature range	TU	-40 - +80 °C	-40 - +80 °C	-40 - +80 °C
Enclosure material / colour		polycarbonate (halogen-free) UL 94-V0 / yellow		
Degree of protection (IEC EN 60529)		IP 20	IP 20	IP 20
Dimension (DIN 43880)		2TE	2TE	2TE
Mounting on		35 mm DIN rail (DIN EN 50 022)		

With remote signalling contact (FM)	EP D TT2+1 275/FM	EP D IT 2P/FM	EPO D IT 3P/FM
Article-No.	38 05 41	38 05 71	38 05 77
Switching capacity	250 V/2 A	250 V/2 A	250 V/2 A
Remote signalling contact	break contact	break contact	break contact

Dimension drawing, see pages 194 to 198





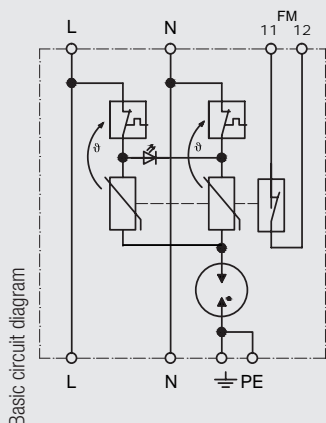

SPD Type 3 for AC power supplies / EnerPro D

EnerPro D TN

Two pole, compact SPD Type 3 (class III) for nominal voltage of 24 V up to 230 V.



- Practical compact housing with minimum space requirement
- Possible with parallel or spur wiring for 16 A
- No leakage currents to earth connection PE
- Line function and equipment control by LED/ Monitoring of conductor and arrester via LED
- Optional remote signalling contact (FM)

				
Technical Data	EP D TN 24V/16A	EP D TN 48V/16A	EP D TN 60V/16A	EP D TN 120V/16A
Article-No.	38 05 50	38 05 53	38 05 56	38 05 59
Nominal voltage AC	UN 24 V~	48 V~	60 V~	120 V~
Max. continuous operating voltage AC	Uc 35 V~	60 V~	75 V~	150 V~
Rated load current	IL 16 A	16 A	16 A	16 A
Protection level L-N	Up ≤ 0,22 kV	≤ 0,35 kV	≤ 0,5 kV	≤ 0,7 kV
Protection level L/N-PE	Up ≤ 1,0 kV	≤ 1,0 kV	≤ 1,0 kV	≤ 1,0 kV
Combined surge	Uoc ≤ 2 kV	≤ 2 kV	≤ 2 kV	≤ 4 kV
Response time L-N/L,N-PE	≤ 25/≤ 100 ns	≤ 25/≤ 100 ns	≤ 25/≤ 100 ns	≤ 25/≤ 100 ns
Nominal discharge current (10 x 8/20)	In 5 kA	5 kA	5 kA	5 kA
Max. operating current	Imax 8 kA	8 kA	8 kA	8 kA
Max. acceptable fuse or back-up fuse	16 A gL/gG	16 A gL/gG	16 A gL/gG	16 A gL/gG
Operating temperature range	TU -40 - +80 °C	-40 - +80 °C	-40 - +80 °C	-40 - +80 °C
Min. conductor cross section at terminals	1.5 mm ² single-wire / 1.0 mm ² flexible with sleeve mm ²			
Max. conductor cross section	2.5 mm ² single-wire / 1.5 mm ² flexible with sleeve mm ²			
Enclosure material / colour	polycarbonate (halogen-free) UL 94-V0 / yellow			
Degree of protection (IEC EN 60529)	IP 20	IP 20	IP 20	IP 20
Mounting on	35 mm DIN rail (DIN EN 50 022)			

With remote signalling contact (FM)	EP D TN 24V/16A /FM	EP D TN 48V/16A/FM	EP D TN 60V/16A /FM	EP D TN 120V/16A/FM
Article-No.	38 05 51	38 05 54	38 05 57	38 05 60
Switching capacity	250 V/2 A	250 V/2 A	250 V/2 A	250 V/2 A
Remote signalling contact	break contact	break contact	break contact	break contact

Dimension drawing, see pages 194 to 198







SURGE PROTECTION FOR POWER SUPPLY SYSTEMS

AC POWER SUPPLY

		
Technical Data	EP D TN 230V/16A	EP D TN 275
Article-No.	38 05 62	38 12 54
Nominal voltage AC	UN 230 V~	230 V~
Max. continuous operating voltage AC	Uc 255 V~	275 V~
Rated load current	IL 16 A	16 A
Protection level L-N	Up ≤ 1,0 kV	≤ 1,0 kV
Protection level L/N-PE	Up ≤ 1,5 kV	≤ 1,5 kV
Combined surge	Uoc ≤ 4 kV	≤ 4 kV
Response time L-N/L,N-PE	≤ 25/≤ 50 ns	≤ 25/≤ 50 ns
Nominal discharge current (8/20)	In 5 kA	5 kA
Max. operating current	Imax 8 kA	8 kA
Max. acceptable fuse or back-up fuse	16 A gL/gG	16 A gL/gG
Operating temperature range	TU -40 - +80 °C	-40 - +80 °C
Max. conductor cross section	2x 2,5 mm ² solid / 2x 1,5 mm ² stranded	2x 2,5 mm ² solid / 2x 1,5 mm ² stranded
Enclosure material / colour	polycarbonate UL 94-V0 / yellow	polycarbonate (halogen-free) UL 94-V0 / yellow
Degree of protection (IEC EN 60529)	IP 20	IP 20
Mounting on	35 mm DIN rail (DIN EN 50 022)	35 mm DIN rail (DIN EN 50 022)



With remote signalling contact (FM)	EP D TN 230V/16A/FM	EP D TN 275/FM
Article-No.	38 05 63	38 12 55
Switching capacity	250 V/2 A	250 V/2 A
Remote signalling contact	break contact	break contact

				
Technical Data	EP D TN 24V/25A	EP D TN 48V/25A	EP D TN 60V/25A	EP D TN 120V/25A
Article-No.	38 05 52	38 05 49	38 05 64	38 05 66
Nominal voltage AC	UN 24 V~	48 V~	60 V~	120 V~
Max. continuous operating voltage AC	Uc 35 V~	60 V~	75 V~	150 V~
Rated load current	IL 25 A	25 A	25 A	25 A
Protection level L-N	Up ≤ 0,22 kV	≤ 0,35 kV	≤ 0,5 kV	≤ 0,7 kV
Protection level L/N-PE	Up ≤ 1,0 kV	≤ 1,0 kV	≤ 1,0 kV	≤ 1,0 kV
Combined surge	Uoc ≤ 2 kV	≤ 2 kV	≤ 2 kV	≤ 4 kV
Response time L-N/L,N-PE	≤ 25/≤ 100 ns	≤ 25/≤ 100 ns	≤ 25/≤ 100 ns	≤ 25/≤ 100 ns
Nominal discharge current (10 x 8/20)	In 5 kA	5 kA	5 kA	5 kA
Max. operating current	Imax 8 kA	8 kA	8 kA	8 kA
Max. acceptable fuse or back-up fuse	25 A gL/gG	25 A gL/gG	25 A gL/gG	25 A gL/gG
Operating temperature range	TU -40 - +80 °C	-40 - +80 °C	-40 - +80 °C	-40 - +80 °C
Min. conductor cross section at terminals	1.5 mm ² single-wire / 1.0 mm ² flexible with sleeve mm ²			
Max. conductor cross section	2.5 mm ² single-wire / 1.5 mm ² flexible with sleeve mm ²			
Enclosure material / colour	polycarbonate (halogen-free) UL 94-V0 / yellow			
Degree of protection (IEC EN 60529)	IP 20	IP 20	IP 20	IP 20
Mounting on	35 mm DIN rail (DIN EN 50 022)			

With remote signalling contact (FM)	EP D TN 24V/25A-FM	EP D TN 48V/25A-FM	EP D TN 60V/25A-FM	EP D TN 120V/25A-FM
Article-No.	38 05 55	38 05 58	38 05 65	38 05 67
Switching capacity	250 V/2 A	250 V/2 A	250 V/2 A	250 V/2 A
Remote signalling contact	break contact	break contact	break contact	break contact

Dimension drawing, see pages 194 to 198



			
Technical Data		EP D TN 230V/25A	EP D TN 275V/25A
Article-No.		38 05 68	38 05 61
Nominal voltage AC	UN	230 V~	230 V~
Max. continuous operating voltage AC	Uc	255 V~	275 V~
Rated load current	IL	25 A	25 A
Protection level L-N	Up	≤ 1,0 kV	≤ 1,0 kV
Protection level L/N-PE	Up	≤ 1,5 kV	≤ 1,5 kV
Combined surge	Uoc	≤ 4 kV	≤ 4 kV
Response time L-N/L,N-PE		≤ 25/≤ 100 ns	≤ 25/≤ 100 ns
Nominal discharge current (10 x 8/20)	In	5 kA	5 kA
Max. operating current	Imax	8 kA	8 kA
Max. acceptable fuse or back-up fuse		25 A gL/gG	25 A gL/gG
Operating temperature range	TU	-40 - +80 °C	-40 - +80 °C
Min. conductor cross section at terminals		1.5 mm ² single-wire / 1.0 mm ² flexible with sleeve mm ²	
Max. conductor cross section		2.5 mm ² single-wire / 1.5 mm ² flexible with sleeve mm ²	
Enclosure material / colour		polycarbonate (halogen-free) UL 94-V0 / yellow	
Degree of protection (IEC EN 60529)		IP 20	IP 20
Mounting on		35 mm DIN rail (DIN EN 50 022)	
With remote signalling contact (FM)		EP D TN 230V/25A-FM	EP D TN 275V/25A-FM
Article-No.		38 05 69	38 05 48
Switching capacity		250 V/2 A	250 V/2 A
Remote signalling contact		break contact	break contact

SPD Type 3 for AC power supplies

EnerPro 220Tr/20kA

Two-pole compact SPD (class III) with a discharge capacity of 20 kA (8/20 μs) and disconnection device without interruption of the power supply (red LED).

- Leakage current free
- Optional mit remote signalling contact (PK)
- Mounting on 35 mm DIN rail

Basic circuit diagram

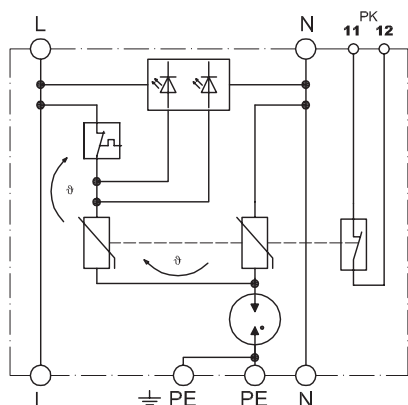

Dimension drawing, see pages 194 to 198

		
Technical Data		EnerPro 220Tr/20kA
Article-No.		38 20 22
Nominal voltage AC	UN	230 V~
Max. continuous operating voltage AC	Uc	275 V~
Rated load current	IL	16 A
Max. acceptable fuse or back-up fuse		16 A gL/gG
Protection level L-N	Up	≤ 1,2 kV
Protection level L/N-PE	Up	≤ 1,4 kV
Response time L-N/L,N-PE		≤ 25/≤ 50 ns
Nominal discharge current (8/20μs) [L(N)-PE]	In	20 kA
Critical discharge current (8/20 μs)	Imax	20 kA
Operating temperature range	TU	-40 - +80 °C
Max. conductor cross section		2.5mm ² solid or 1.5mm ² flexible
Recommended conductor cross section		1,5 / 2,5 mm ²
Enclosure material / colour		polycarbonate UL 94-V0/yellow
Mit Remote signalling contact		EnerPro 220Tr/20kA /Pk
Article-No.		38 20 23
Switching capacity		250 V/2 A
Remote signalling contact		break contact



SPD Type 3 for AC power supplies

EnerPro 150Tr/Pk

Surge protection for equipment and installations up to 100 A and 150 V. SPD class III.

- High performance arrester for 150 V operating voltage
- Function control indication via LED
- Signalling contact (break contact) with pluggable terminal (PK)

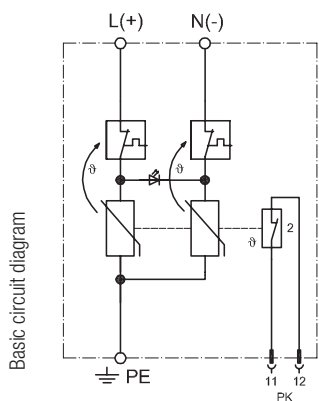

Technical Data	EnerPro 150Tr/Pk
Article-No.	38 20 25
Nominal voltage DC	UN 150 V=
Max. continuous operating voltage AC	Uc 170 V~
Lightning impulse current (10/350) L,N-PE	Iimp 8 kA
Critical discharge current (8/20 μs)	I _{max} 40 kA
Voltage protection level at Iimp (10/350)	Up ≤ 1,0 kV
Max. acceptable fuse or back-up fuse	125 A gL/gG
Response time	tA ≤ 25 ns
Max. conductor cross section	50 mm ² single wire / 35 mm ² stranded / 25 mm ² fine-stranded with sleeve
Operating temperature range	TU -40 - +80 °C
Max. conductor cross section Pk	1.5 mm ²
Max. current carrying capacity PK	250 V/2 A
Enclosure material / colour	polycarbonate UL 94-V0/yellow
Mounting on	35 mm DIN rail form C (EN 50 022)

EnerPro D 230 KM

Surge arrester for installation systems and terminal equipment with acoustic fault indication.

- Applicable at the boundaries LPZ 1 - 2 and higher
- Test standard: IEC 61643-1 / EN 61643-11
- Universal device for use in cable ducts and holder boxes
- Class III 2-pole mini SPD (fine protection)
- Protection against longitudinal and transverse voltages for loads up to 16 A
- Valve arrester SPD (leakage-current free)

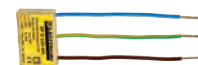
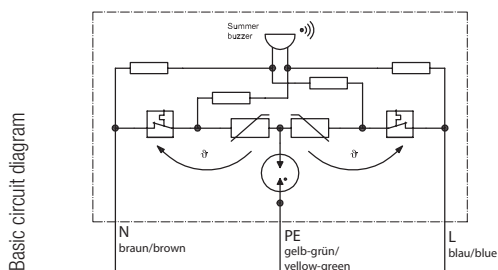

Technical Data	EP D 230 KM
Article-No.	36 20 35
EC category/EN type	Type 3 / class III
Nominal voltage AC	UN 230 V~
Max. continuous operating voltage AC	Uc 255 V~
Max. allowed prefuse	16 A gL/gG
Rated load current	IL 16 A
Protection level L-N	Up ≤ 1,25 kV
Protection level L/N-PE	Up ≤ 1,5 kV
Response time L-N/L,N-PE	≤ 25/≤ 100 ns
Nominal discharge current (8/20)	I _n 3 kA
Max. operating current	I _{max} 6 kA
Operating temperature range	TU -15 - +60 °C
Combined surge generator impulse	Uoc 6 kV
Conductor length	ca. 100 mm
Dimensions L x W x H	36 x 24 x 9 mm
Enclosure material / colour	polycarbonate UL 94-V0/yellow
Mounting on	under-floor systems, cable trays and device installation boxes

Dimension drawing, see pages 194 to 198



SPD Type 3 for AC power supplies

EnerPro 230 SDU

Two-pole surge arrester (class III) for the protection of electronical devices, for the retrofitting of deep 230 V flush-mounted boxes.

- Applicable at the boundaries LPZ 1 - 2 and higher
- Test standard: IEC 61643-1 / EN 61643-11
- Acoustic failure signal
- Including disconnection mechanism
- Valve arrester SPD (leakage-current free)

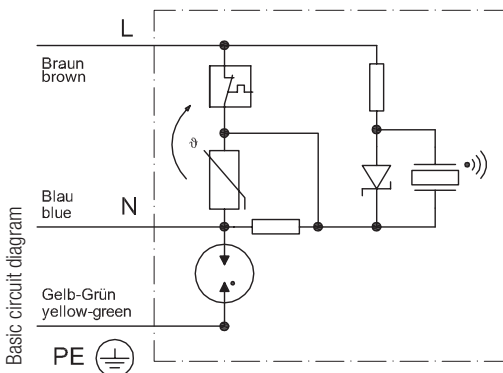

Technical Data	EnerPro 230 SDU
Article-No.	24 00 02
EC category/EN type	Type 3 / class III
Nominal voltage AC	UN 230 V~
Rated load current	IL 16 A
Protection level L-N	Up ≤ 1,25 kV
Protection level L/N-PE	Up ≤ 1,5 kV
Response time	tA < 25 ns
Nominal discharge current (8/20)	In 2,5 kA
Max. operating current	Imax 5 kA
Operating temperature range	TU -20 - +80 °C
Type of connection	3-wire
Mounting type	installation in 230V flush sockets

NM 220V

Surge voltage protection module for the protection of single-phase 230 V equipment with max. 16 A power consumption.

- Applicable at the boundaries LPZ 1 - 2 and higher
- Test standard: IEC 61643-1 / EN 61643-11
- Compact module for equipment installation
- Protection against longitudinal and transverse voltages
- Valve arrester SPD (leakage-current free)

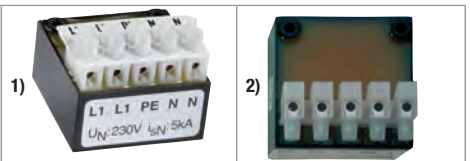
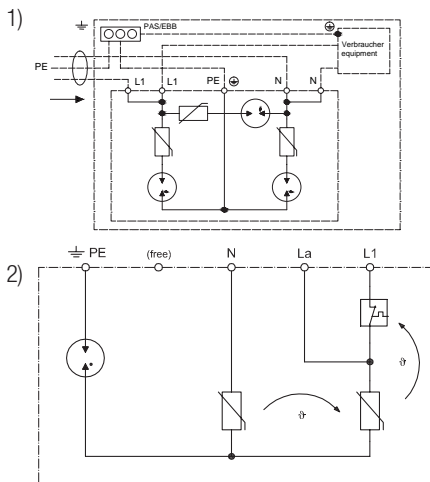

Technical Data	NM 220V/5kA	NM 220V/20kA
Article-No.	36 05 22	36 20 22
EC category/EN type	Type 3 / class III	Type 3 / class III
Nominal voltage AC	UN 230 V~	230 V~
Rated load current	IL 16 A	16 A
Protection level L-N	Up ≤ 1,0 kV	≤ 1,2 kV
Protection level L/N-PE	Up ≤ 1,5 kV	≤ 1,4 kV
Response time	tA ≤ 25 ns	≤ 25 ns
Nominal discharge current (8/20μs) line-earth	In 5 kA	20 kA
Nominal discharge current (8/20μs) line-line	In 2,5 kA	15 kA
Max. current (8/20 μs) line-line	Ig 8 kA	15 kA
Max. current (8/20 μs) line-earth	Ig 15 kA	20 kA
Operating temperature range	TU -20 - +80 °C	-20 - +80 °C
Mounting	2x M3-screws (30mm)	2x M3-screws (30mm)
Type of connection	Screw terminals	Screw terminals

Dimension drawing, see pages 194 to 198



EnerPro 48V/100A-Tr

Surge voltage protector for equipment power supplies and installations up to 100 A and 48 V AC/DC.



Basic circuit diagram

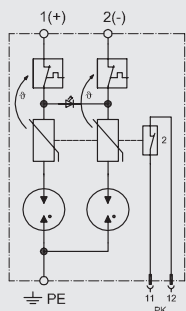

- High performance surge protector
- Valve arrester SPD (leakage-current free)
- Function control indication via LED
- Optional potential-free remote signalling contact (PK)

Technical Data	EnerPro 48V/100A-Tr	EnerPro 48V/100A-Tr/Pk
Article-No.	38 20 70	38 20 71
Nominal voltage DC	UN 48 V=	48 V=
Nominal voltage AC	UN 34 V~	34 V~
Max. continuous operating voltage DC	Uc 60 V=	60 V=
Max. continuous operating voltage AC	Uc 42 V~	42 V~
Protection level at 1kV/μs (1,2-PE)	Uas ≤ 0,2 kV	≤ 0,2 kV
Protection level at In (1, 2-PE)	Ures ≤ 0.3 kV	≤ 0.3 kV
Response time	tA < 25 ns	< 25 ns
Nominal discharge current (8/20)	In 15 kA	15 kA
Max. impulse discharge current (8/20)	Imax 30 kA	30 kA
Max. acceptable fuse or back-up fuse	125 A gL/gG	125 A gL/gG
Max. conductor cross section at terminals	stranded 50/fine stranded 35 mm ²	stranded 50/fine stranded 35 mm ²
Operating temperature range	TU -40 - +80 °C	-40 - +80 °C
Recommended conductor cross section	25 mm ²	25 mm ²
Max. connection torque for terminals	4,5 Nm	4,5 Nm
Enclosure material / colour	polycarbonate UL 94-V0 / yellow	polycarbonate (halogen-free) UL 94-V0 / yellow
Degree of protection (IEC EN 60529)	IP 20	IP 20
Mounting on	35 mm DIN rail (DIN EN 50 022)	35 mm DIN rail (DIN EN 50 022)

Dimension drawing, see pages 194 to 198



EnerPro mit 6A/LED



Surge voltage arrester for electrical and electro-nical devices in looped-in wiring, with disconnection device without interruption of the power supply.

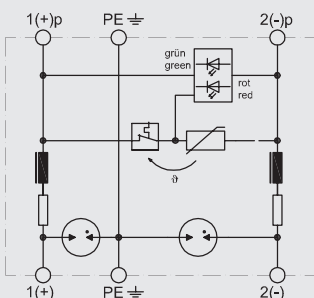

Basic circuit diagram



- Two-pole SPD for operating current up to 6 A

			
Technical Data	EnerPro 12V-6A/LED	EnerPro 24V-6A/LED	EnerPro 36V-6A/LED
Article-No.	24 12 02	24 24 02	24 36 02
Rated voltage DC (1-2/1p-2p)	Uc 12 V	24 V	36 V
Rated voltage (between 1-2 resp. 1p-2p) AC	Uc 8 V	17 V	24 V
Max. operating voltage DC (1-2 / 1p-2p)	Umax 15 V	27 V	40 V
Max. operating voltage AC (1-2 /1p-2p)	Umax 10 V	20 V	29 V
Max. operating current	IL 6 A	6 A	6 A
Protection level (line-earth)	Up 650 V	650 V	650 V
Response time	tA < 25 ns	< 25 ns	< 25 ns
Series inductance, typ.	L 20 µH	20 µH	20 µH
Protection level line-line at 1kV/µs and limp	Urest ≤ 80 V	≤ 100 V	≤ 200 V
Short-circuit current extinguishing capacity line-line	≤ 6 A	≤ 6 A	≤ 6 A
Short-circuit current extinguishing capacity line-earth	≤ 1 A	≤ 1 A	≤ 1 A
Max. impulse discharge current (8/20)	I _{max} 40 kA	40 kA	40 kA
Service life test current (500 x 10/700 µs)	i _l 200 A	200 A	200 A
Critical discharge current (10/700 µs)	1000 A	1000 A	1000 A
Max. alternating discharge current (50 Hz/ 5x 0,5s)	I _{wn} 50 A	50 A	50 A
Max. current 50 Hz/0.5 s	I _g 80 A	80 A	80 A
Conductor cross section	Cu, 35mm ² flexible with sleeve	Cu, 35mm ² flexible with sleeve	Cu, 35mm ² flexible with sleeve
Dimensions (L x W x H)	52,5 x 90 x 64	52,5 x 90 x 64	52,5 x 90 x 64
Operating temperature range	TU -40 - +80 °C	-40 - +80 °C	-40 - +80 °C

Dimension drawing, see pages 194 to 198



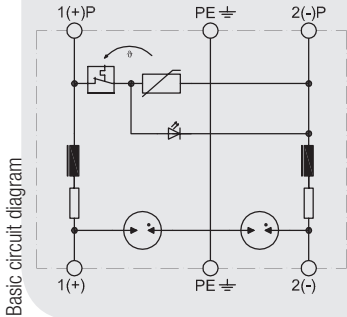

EnerPro mit 20A/LED

Two-pole SPD for operating current up to 20 A in looped-in wiring, with disconnection device without interruption of the power supply.



■ Surge voltage protection for electrical and electronic devices

		without fig.	without fig.	
Technical Data	EP 12V-20A/LED	EP 24V-20A/LED	EP 36V-20A/LED	EP 48V-20A/LED
Article-No.	24 12 03	24 24 03	24 36 03	24 48 03
Rated voltage DC (1-2/1p-2p)	Uc 12 V	24 V	36 V	48 V
Rated voltage (between 1-2 resp. 1p-2p) AC	Uc 8 V	17 V	24 V	30 V
Max. operating voltage DC (1-2 / 1p-2p)	Umax 15 V	27 V	40 V	53 V
Max. operating voltage AC (1-2 / 1p-2p)	Umax 10 V	20 V	29 V	37 V
Max. operating current	IL 20 A	20 A	20 A	20 A
Protection level line-line at 1kV/µs and limp	Urest ≤ 80 V	≤ 100 V	≤ 200 V	≤ 300 V
Response time	tA 25 ns	25 ns	25 ns	25 ns
Short-circuit current extinguishing capacity line-line	≤ 6 A	≤ 6 A	≤ 6 A	≤ 6 A
Short-circuit current extinguishing capacity line-earth	≤ 1 A	≤ 1 A	≤ 1 A	≤ 1 A
Nominal discharge current L1, L2-PE (8/20µs)	20 kA	20 kA	20 kA	20 kA
Max. impulse discharge current L1, L2-PE (8/20µs)	Imax 40 kA	40 kA	40 kA	40 kA
Max. impulse discharge current L1+L2-PE (8/20µs)	Imax 80 kA	80 kA	80 kA	80 kA
Operating temperature range	TU -40 - +80 °C	-40 - +80 °C	-40 - +80 °C	-40 - +80 °C
Conductor cross section	Cu, solid 50mm ² /flexible 35mm ² with sleeve		Cu, solid 50mm ² /flexible 35mm ² with sleeve	
Dimensions (L x W x H)	64 x 90 x 52,5 mm	64 x 52,5 x 90 mm	64 x 90 x 52,2 mm	64 x 90 x 52,5 mm
Degree of protection (IEC EN 60529)	IP 20	IP 20	IP 20	IP 20
Enclosure material / colour	polycarbonate (halogen-free) UL 94-V0 / yellow		polycarbonate (halogen-free) UL 94-V0 / yellow	



EnerPro V-Tr



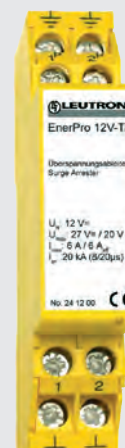

Two-pole class II and III SPD with gas-filled surge arrester (GDT) and suppressor diodes for operating currents up to 6 A.

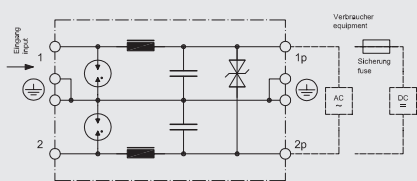

Basic circuit diagram



- Two-step protective circuit with integrated low-pass filter
- High performance surge protector for operating voltage of 24 V up to 60 V DC
- Mounting directly on mounting plate or on 35 mm DIN rail

					
Technical Data	EnerPro 12V-Tr	EnerPro 24V-Tr	EnerPro 36V-Tr	EnerPro 48V-Tr	EnerPro 60 V-Tr
Article-No.	24 12 00	24 24 00	24 36 00	24 48 00	24 60 00
Nominal voltage DC	UN 12 V=	24 V=	36 V=	48 V=	60 V=
Nominal voltage AC	UN 8 V~	17 V~	24 V~	30 V~	43 V~
Max. continuous operating voltage DC	Uc 15 V=	27 V=	40 V=	53 V=	85 V=
Max. continuous operating voltage AC	Uc 10 V~	20 V~	29 V~	37 V~	60 V~
Max. operating current	IL 6 A	6 A	6 A	6 A	6 A
Leakage current at Umax DC	IL ≤ 5 µA	≤ 5 µA	≤ 5 µA	≤ 5 µA	≤ 5 µA
DC resistance	R 27 Ω	27 Ω	27 Ω	27 Ω	27 Ω
Series inductance, typ.	L 20 µH	20 µH	20 µH	20 µH	20 µH
Protection level line-earth at 1 kV/µs and In	≤ 800, typ. 650 V	≤ 800, typ. 650 V	≤ 800, typ. 650 V	≤ 800, typ. 650 V	≤ 800, typ. 650 V
Protection level line-line at 1 kV/µs and In	Urest ≤ 20 / 27 V	≤ 37 / 55 V	≤ 55 / 85 V	≤ 85 / 110 V	≤ 95/125 V
Short-circuit current extinguishing capacity line-line	≤ 6 A	≤ 6 A	≤ 6 A	≤ 1.0 A	≤ 1 A
Short-circuit current extinguishing capacity line-earth	≤ 1 A	≤ 1 A	≤ 1 A	≤ 0,75 A	≤ 0,75 A
Nominal impulse discharge current (10 x 8/20)	In 20 kA	20 kA	20 kA	20 kA	20 kA
Service life test current (500 x 10/700 µs)	ii 200 A	200 A	200 A	200 A	200 A
Critical discharge current (10/700 µs)	1000 A	1000 A	1.000 A	1000 A	1000 A
Max. alternating discharge current (50 Hz/ 5x 0,5s)	Iwn 50 A	50 A	50 A	50 A	50 A
Max. current 50 Hz/0.5 s	Ig 80 A	80 A	80 A	80 A	80 A
Operating temperature range	-40 - +80°C	-40 - +80°C	-40 - +80°C	-40 - +80°C	-40 - +80°C
Conductor cross section	2.5mm ² solid or 1.5mm ² flexible with sleeve	2.5mm ² solid or 1.5mm ² flexible with sleeve	2.5mm ² solid or 1.5mm ² flexible with sleeve	2.5mm ² solid or 1.5mm ² flexible with sleeve	2.5mm ² solid or 1.5mm ² flexible with sleeve

Dimension drawing, see pages 194 to 198



SURGE PROTECTION FOR POWER SUPPLY SYSTEMS

SURGE ARRESTER FOR PV INSTALLATIONS

Combined arrester type 1 + 2 for DC power supplies

PowerPro PV



When applied in PV installations, these devices are placed inside the connection box of the solar generator and on the DC side of the inverter.

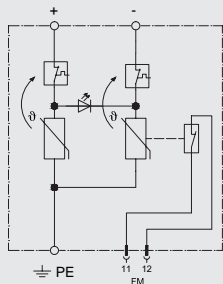

Basic circuit diagram



- Two-pole DC combined modular arrester, class I and II.
- Applicable at the LPZ transition point OA-1 and higher
- Test standard: IEC 61643-1 / EN 61643-11
- Mounting on 35 mm DIN rail
- Optional remote signalling contact (FM)

		
Technical Data	PP PV 800	PP PV 1000
Article-No.	37 44 00	37 44 02
IEC category/EN type	type 1 + 2 / class I + II	type 1 + 2 / class I + II
PV voltage	UocSTC 800 V=	1000 V=
Max. continuous operating voltage DC	Uc 850 V=	1100 V=
Protection level at In	Up ≤ 2,2 kV	≤ 4,2 kV
Protection level at 5 kA	Up ≤ 1,8 kV	≤ 3,5 kV
Response time	tA ≤ 25 ns	≤ 25 ns
Lightning impulse current (10/350) per pole	Iimp 12,5 kA	12,5 kA
Max. impulse discharge current (8/20)	Imax 40 kA	40 kA
Operating temperature range	TU -40 - +80 °C	-40 - +80 °C
Min. conductor cross section at terminals	10 mm ²	10 mm ²
Max. conductor cross section at terminals	35mm ² stranded/25mm ² flexible	35mm ² stranded/25mm ² flexible
Max. connection torque for terminals	4,5 Nm	4,5 Nm
Enclosure material / colour	polycarbonate UL 94-V0 / yellow	polycarbonate (halogen-free) UL 94-V0 / yellow
Degree of protection (IEC EN 60529)	IP 20	IP 20
Dimension (DIN 43880)	2 TE	3 TE

With remote signalling contact (FM)	PP PV 800/FM	PP PV 1000/FM
Article-No.	37 44 01	37 44 03
Max. operating voltage	250 V AC/125 V DC	250 V AC/125 V DC
Max. operating current	1 A AC/ 200 mA DC	1 A AC/ 200 mA DC

Accessories	
Article-No.	DAK 2x 16 17 01 10



Adapter to enable feed-through wiring (V-wiring) for all surge protection modules with only one clamp per phase, such as PP PV 800 and 1000 and other SPDs for power supply systems.

Dimension drawing, see pages 194 to 198



SPD type 2 for DC power supplies

CT PV-T2

Fully pluggable surge protective arrester for the use in photovoltaic applications. Suitable fuse-free earthed photovoltaic applications with system voltages up to 600 or 1000 V DC.

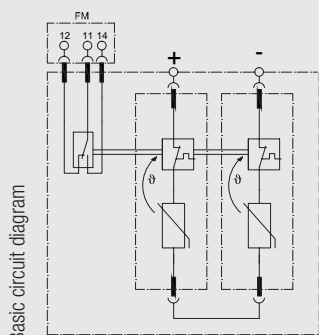

Basic circuit diagram



- Applicable at the boundaries LPZ 0B - 1 and higher
- Test standard: IEC 61643-1 / EN 61643-11
- Mounting on 35 mm DIN rail (EN 60715)
- Degree of protection according to IEC EN

- 60529: IP 20
- Enclosure material: thermoplastic (yellow)
- Inflammability class according to UL 94 V0
- Dimension: 36 mm and 54 mm
- Optional remote changeover contact

Technical Data	CT PV-T2-2-0/600	CT PV-T2-2-0/1000	CT PV-T2/2+1/600	CT PV-T2/2+1/1000
Article-No.	96 02 20	96 02 22	96 02 24	96 02 26
IEC category/EN type	Typ 2 / class II	Type 2 / class II	Type 2 / class II	Type 2 / class II
Open-circuit voltage	UOC max. ≤ 600 V=	≤ 1000 V=	≤ 600 V=	≤ 1000 V=
Max. continuous operating voltage DC	Uc 600 V=	1000 V=	600 V=	1000 V=
Max. short-circuit current	ISC max. tbd.	tbd.	tbd.	tbd.
Nominal discharge current (8/20)	In 15 kA	15 kA	15 kA	15 kA
Max. impulse discharge current (8/20)	I _{max} 30 kA	30 kA	30 kA	30 kA
Protection level L+-L-	Up 3 kV	5 kV	3 kV	5 kV
Protection level L+/L- -PE	Up -	-	3 kV	5 kV
Operating temperature range	TU -40 - +80 °C	-40 - +80 °C	-40 - +80 °C	-40 - +80 °C
Min. conductor cross section at terminals	1.5mm ² solid/flexible	1.5mm ² solid/flexible	1.5mm ² solid/flexible	1.5mm ² solid/flexible
Max. conductor cross section at terminals	35mm ² stranded/25mm ² flexible	35mm ² stranded/25mm ² flexible	35mm ² stranded/25mm ² flexible	35mm ² stranded/25mm ² flexible
Dimension (DIN 43880)	36 mm	36 mm	54 mm	54 mm

With remote signalling contact (FM)	CT PV-T2-2-0/600-FM	CT PV-T2-2-0/1000-FM	CT PV-T2/2+1/600-FM	CT PV-T2/2+1/1000-FM
Article-No.	96 02 21	96 02 23	96 02 25	96 02 27
Max. operating voltage	250 V AC/125 V DC	250 V AC/125 V DC	250 V AC/125 V DC	250 V AC/125 V DC
Max. operating current	1 A AC/ 200 mA DC	1 A AC/ 200 mA DC	1 A AC/ 200 mA DC	1 A AC/ 200 mA DC

Accessories (Moduls)			
	CT PV-T2-600-M	CT PV-T2-1000-M	CT PV-T2-1000-MS
Article-No.	96 02 46	96 02 47	96 02 50

Replacement protective plug for DC surge arresters typ 2.

Dimension drawing, see pages 194 to 198



SPD type 2 for DC power supplies

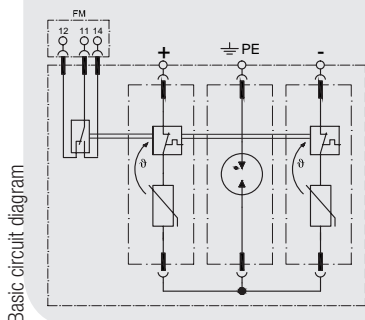
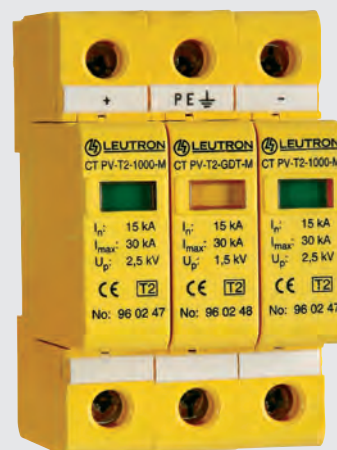

CT PV-T2/2+GDT

Fully pluggable surge protective arrester for the use in photovoltaic applications. Suitable fuse-free earthed photovoltaic applications with system voltages up to 600 or 1000 V DC.



Basic circuit diagram

- Applicable at the boundaries LPZ 0B - 1 and higher
- Leakage current free
- Test standard: IEC 61643-1 / EN 61643-11
- Mounting on 35 mm DIN rail (EN 60715)
- Degree of protection according to IEC EN 60529: IP 20
- Inflammability class according to UL 94 V0
- Dimension: 54 mm (3 TE)
- Optional remote changeover contact

		
Technical Data	CT PV-T2/2+GDT/600	CT PV-T2/2+GDT/1000
Article-No.	96 02 28	96 02 30
IEC category/EN type	Type 2 / class II	Type 2 / class II
Open-circuit voltage	UOC max. ≤ 600 V=	≤ 1000 V=
Max. continuous operating voltage DC	Uc 600 V=	1000 V=
Max. short-circuit current	ISC max. tbd.	tbd.
Nominal discharge current (8/20)	In 15 kA	15 kA
Max. impulse discharge current (8/20)	I _{max} 30 kA	30 kA
Protection level L+-L-	Up 3 kV	5 kV
Protection level L+/L- -PE	Up 3 kV	3 kV
Operating temperature range	TU -40 - +80 °C	-40 - +80 °C
Min. conductor cross section at terminals	1.5mm ² solid/flexible	1.5mm ² solid/flexible
Max. conductor cross section at terminals	35mm ² stranded/25mm ² flexible	35mm ² stranded/25mm ² flexible
Dimension (DIN 43880)	54 mm	54 mm

With remote signalling contact (FM)	CT PV-T2/2+GDT/600-FM	CT PV-T2/2+GDT/1000-FM
Article-No.	96 02 29	96 02 31
Max. operating voltage	250 V AC/125 V DC	250 V AC/125 V DC
Max. operating current	1 A AC/ 200 mA DC	1 A AC/ 200 mA DC

Accessories (Moduls)			
	CT PV-T2-600-M	CT PV-T2-1000-M	CT PV-T2-GDT-M
Article-No.	96 02 46	96 02 47	96 02 48

Replacement protective plug for DC surge arresters typ 2.



SPD type 2 for DC power supplies

EnerPro 803/1003-Tr

Surge arrester for PV installations, with looped-in wiring.

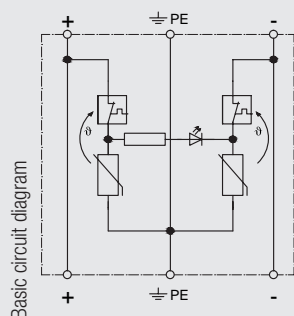

- When used in PV-installations, they are installed in the generator connection box and on the DC side of the AC converter.

			
Technical Data		EP 803Tr	EP 1003Tr
Article-No.		39 50 26	39 50 03
PV voltage	UocSTC	800 V=	1000 V=
Max. continuous operating voltage DC	Uc	895 V=	1000 V=
Protection level at In	Up	≤ 2,5 kV	≤ 3,5 kV
Protection level at 5 kA	Up	≤ 1,8 kV	≤ 3,5 kV
Response time	tA	≤ 25 ns	≤ 25 ns
Nominal discharge current (8/20)	In	10 kA	5 kA
Max. impulse discharge current (8/20 µs) line to PE	Imax	20 kA	10 kA
Max. acceptable fuse or back-up fuse		125 A gL/gG	125 A gL/gG
Operating temperature range	TU	-40 - +80 °C	-40 - +80 °C
Min. conductor cross section at terminals		2,5 mm ²	2,5 mm ²
Max. conductor cross section (L1, L2, PE)		50mm ² stranded/35mm ² flexible	50mm ² stranded/35mm ² flexible
Max. connection torque for terminals		4,5 Nm	4,5 Nm
Enclosure material / colour		polycarbonate (halogen-free) UL 94-V0 / yellow	
Casting compound		Polyurethane	Polyurethane
Degree of protection (IEC EN 60529)		IP 20	IP 20
Mounting on		35 mm DIN rail (DIN EN 50 022)	35 mm DIN rail (DIN EN 50 022)

Dimension drawing, see pages 194 to 198





SPD type 2 for DC power supplies

EnerPro 802Tr and 1002Tr

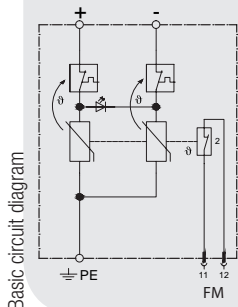
These devices (class II) provide overvoltage protection for the dc part in PV installations.



- When used in PV-installations, they are installed in the generator connection box and on the DC side of the AC converter.
- Optional potential-free remote signalling contact (PK)

			
Technical Data	EnerPro 802Tr	EnerPro 802Tr/Pk	EnerPro 1002Tr
Article-No.	39 50 04	39 50 05	39 50 02
Max. continuous operating voltage DC	Uc 880 V=	880 V=	1000 V=
PV voltage	UocSTC 800 V=	800 V=	1000 V=
Protection level at In (8/20)	Up ≤ 2,5 kV	≤ 2,5 kV	≤ 3,5 kV
Protection level at 5 kA	Up ≤ 2,0 kV	≤ 2,0 kV	≤ 3,5 kV
Response time	tA < 25 ns	< 25 ns	≤ 25 ns
Nominal discharge current (8/20)	In 5 kA	5 kA	5 kA
Max. acceptable fuse or back-up fuse	125 A gL/gG	125 A gL/gG	125 A gL/gG
Max. impulse discharge current (8/20 μs) line to PE	Imax 10 kA	10 kA	10 kA
Operating temperature range	TU -40 - +80 °C	-40 - +80 °C	-40 - +80 °C
Max. conductor cross section	stranded 50 mm ² /fine stranded 35 mm ²		
Min. conductor cross section at terminals	10mm ² solid/flexible	10mm ² solid/flexible	10mm ² solid/flexible
Max. connection torque for terminals	4,5 Nm	4,5 Nm	4,5 Nm
Enclosure material / colour	polycarbonate (halogen-free) UL 94-V0 / yellow		
Mounting on	35 mm DIN rail (DIN EN 50 022)	35 mm DIN rail (DIN EN 50 022)	35 mm DIN rail form C (EN 50 022)
Degree of protection (IEC EN 60529)	IP 20	IP 20	IP 20
FM contact / contact type		break contact	
Switching capacity		250 V/2 A	

Dimension drawing, see pages 194 to 198





SPD type 2 for DC power supplies

EnerPro 802/1002 with 20kA

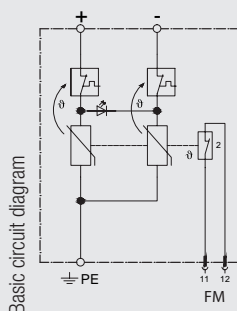
These devices (class II) provide overvoltage protection for the dc part in PV installations.



- When used in PV-installations, they are installed in the generator connection box and on the DC side of the AC converter.

		
Technical Data	EP 802/20kA-Tr	EP 1002/20kA-Tr
Article-No.	39 50 14	39 50 16
PV voltage	UocSTC 800 V=	1000 V=
Max. continuous operating voltage DC	Uc 1000 V=	1000 V=
Protection level at In	Up ≤ 2,5 kV	≤ 4,2 kV
Protection level at 5 kA	Up ≤ 2,0 kV	≤ 3,5 kV
Response time	tA < 25 ns	< 25 ns
Nominal discharge current (8/20)	In 20 kA	20 kA
Max. impulse discharge current (8/20 μs) line to PE	Imax 40 kA	40 kA
Max. acceptable fuse or back-up fuse	125 A gL/gG	125 A gL/gG
Operating temperature range	TU -40 - +80 °C	-40 - +80 °C
Min. conductor cross section at terminals	10mm ² solid/flexible	10mm ² solid/flexible
Max. conductor cross section (L1, L2, PE)	50mm ² stranded/35mm ² flexible	50mm ² stranded/35mm ² flexible
Enclosure material / colour	polycarbonate (halogen-free) UL 94-V0 / yellow	
Casting compound	Polyurethane	Polyurethane
Degree of protection (IEC EN 60529)	IP 20	IP 20
Mounting on	35 mm DIN rail (DIN EN 50 022)	35 mm DIN rail (DIN EN 50 022)



UAS 230-Tr

All-purpose acoustic signalling device with test key for all surge protection devices with the nominal voltage of UN 230 V.

- For monitoring of remote contacts of surge protection devices
- Mounting on 35 mm DIN rail (EN 60715)

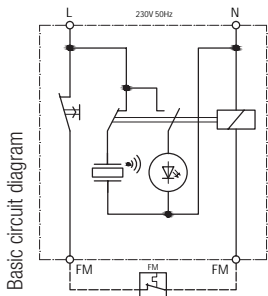

Technical Data		UAS 230-Tr	
Article-No.		35 10 30	
Nominal voltage AC	UN	230 V~	
Max. continuous operating voltage DC	Uc	240 V=	
Nominal current	IL	16 A	
Max. power		530 (Relais) W	
Coil resistance		26,9 Ω	
Max. conductor cross section at terminals		35mm ² stranded/25mm ² flexible	
Operating temperature range	TU	-25 - +65 °C	
Max. conductor cross section at terminals FM		1,5 mm ²	
Degree of protection (IEC EN 60529)		IP 20	
Enclosure material / colour		polycarbonate UL 94-V0 / yellow	

Busbars

The all-purpose busbar is designed to connect the earthing of arrester class II and III lightning and surge voltage components.

- All-purpose busbar for multi-function terminals
- For an optimal bridging of the grounding terminals
- Available in different lengths



		without fig.		without fig.	without fig.		without fig.
Article-No.	KA 1TE-1/2 17 00 15	KA 1TE-1/3 17 00 13	KA 1TE-1/4 17 00 25	KA 1TE-1/6 17 00 31	KA 1TE-1/8 17 00 42	KA 2TE-1/3 17 00 35	KA 2TE-1/4 17 00 41
Dimension (DIN 43880)	2x 1TE	3x 1TE	4x 1TE	6x 1TE	8x 1TE	2x 1TE	2x 1TE

AK35 GDT230

The solution allows for a subsequent high-resistance and leakage current-free earthing with a gas-filled surge arrester (GDT) against earth at the EP protective devices.

- Equipped with two-pole gas-filled surge arrester 2EL 230Q
- Screw-type terminal
- Terminals are internally bridged



Technical Data		AK35 GDT230	
Article-No.		17 01 00	
Type of connection		Screw-type terminal	
Nominal discharge current (8/20)		20 kA	
Dimension		50 x 20 x 10 mm	

DAK 2x16

Pin-shaped terminal to enable feed-through wiring (V-wiring) for all surge protection modules with only one clamp per phase.

- Looped-in wiring for SPDs with only one terminal
- Connection of max. 2x 16 mm² fine stranded
- According to IEC 60364-5-53



Technical Data		DAK 2x 16	
Article-No.		17 01 10	
Type of connection		front (double terminal)	
Max. Cross sectional area		2x 16 mm ²	
Dimension		17 x 38,5 x 21 mm	

Dimension drawing, see pages 194 to 198

SELECTION OF SPDs FOR PV SUPPLY SYSTEMS

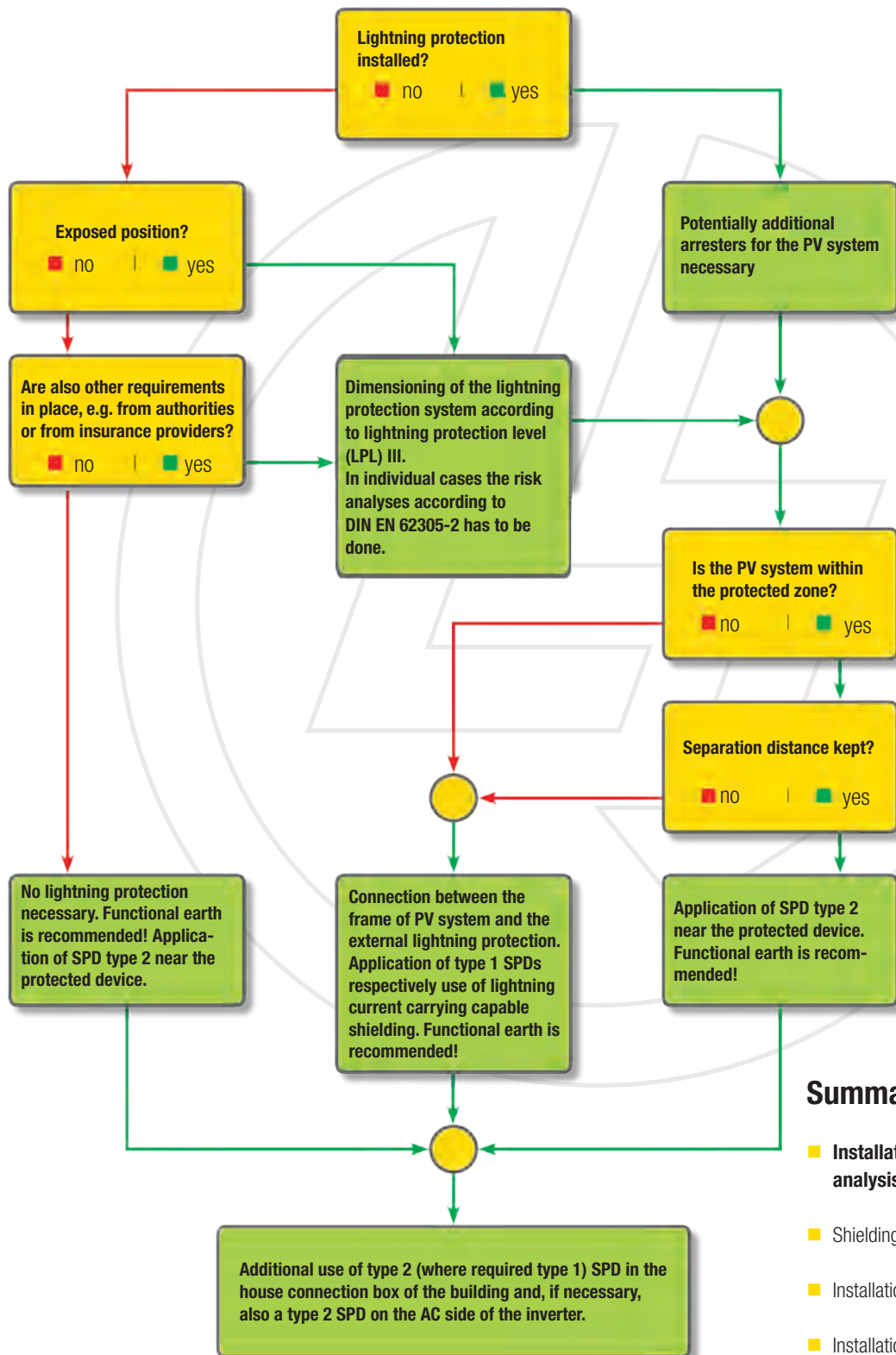

Summary

- Installation of PV module according to risk analysis (VDE 0185-3-4)
- Shielding of primary generator line
- Installation of combined arrester
- Installation of combined arrester after entry building point
- Set-up of suitable protection units
- Installation of protection components at CEP

Flow chart for selecting SPDs in PV supply systems according to DIN EN 62305-3 supplemental sheet 5

THE NEW ARRESTERS – INTERRUPTION-FREE AND IMPEDANCE-NEUTRAL PLUGGING AND UNPLUGGING WITHOUT INTERRUPTING THE SIGNAL

The two-part protection devices with a construction width of 17.5 mm cover up to seven voltage types. Devices with a one-piece terminal block design and a construction width of only 6.2 mm allow for a high packing density in control cabinets.

Convincing application advantages thanks to a symbiosis of design and optimized packing density – Leutron's new arresters for measuring systems and automatic control devices



MORE VERSATILE IN USE:

- Optimized basic modules for direct or indirect shield grounding via gas discharge tubes
- On pluggable surge protective devices the protection module can be detached and replaced without interrupting the signal
- Versions for one pair of wires (1DA) with two signal lines and for two pairs of wires (2DA) with four signal lines available



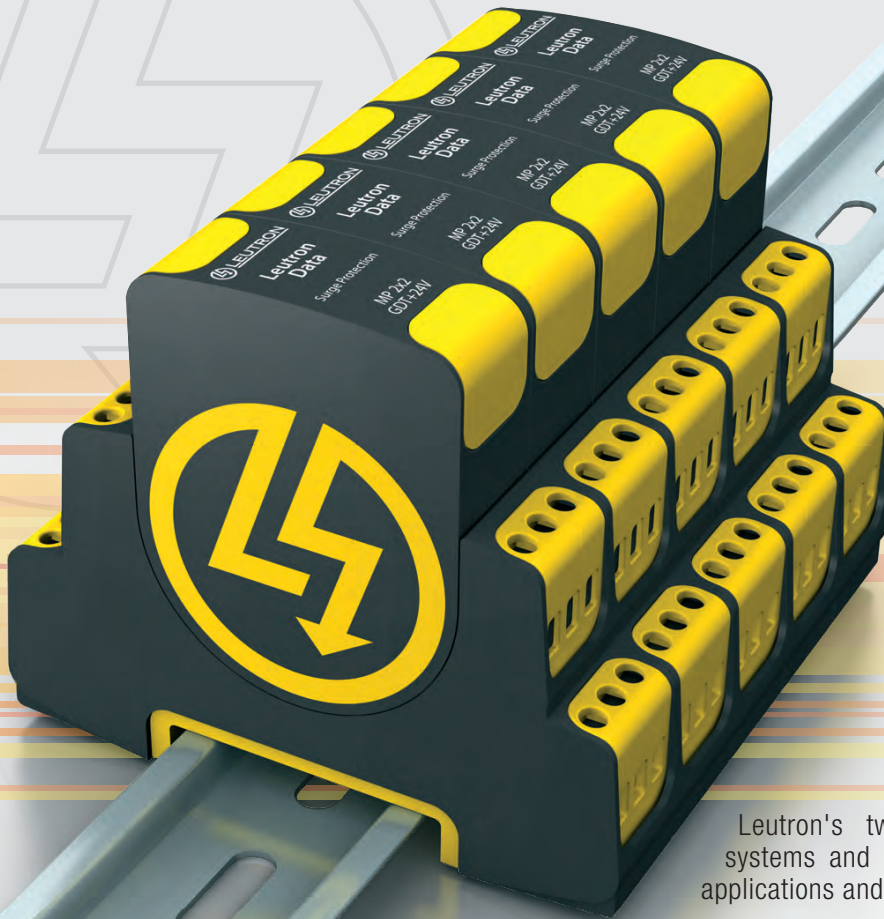

Leutron's two-piece arresters for measuring systems and automatic control devices – for all applications and voltage levels.

SURGE PROTECTION FOR MEASURING SYSTEMS AND AUTOMATIC CONTROL DEVICES

TWO-PIECE, PLUGGABLE SURGE ARRESTERS

New product line »Leutron Data«:

- Voltage levels from 5 V to 180 V DC available
- Frequency range: Dependent on the voltage level up to 170 MHz
- Vibration and Shock test according standard: DIN EN 60068-2-6 and DIN EN 60068-2-27

Space-saving installation width of only 18 mm required for up to four single wires

Impedance-neutral replacing of protection modules

Contacting to mounting rail with lightning current carrying capability

Wiring connection up to 4 mm² solid and 2,5 mm² flexible

Variable shield grounding: Basic modules for direct or indirect shield grounding via gas discharge tube available





ONE-PIECE SURGE ARRESTERS

- Voltage levels from 5 V to 180 V DC available
- Frequency range: Dependent on the voltage level up to 25 MHz

Space-saving installation
width of only 6.2 mm

Contacting to
mounting rail with
lightning current carrying
capability

Wiring
connection up
to 4 mm² solid and
2,5 mm² flexible



SURGE PROTECTION FOR MEASURING SYSTEMS AND AUTOMATIC CONTROL DEVICES

SELECTION GUIDE

Interface / Signal	Connection	Protected lines	Protection device	Article-No.	Page
0-20 mA, 4-20 mA	Screw terminals	4	MP 2x2 GDT+24V-Ad-Pg ST	97 00 27	74
(auch mit HART)	Screw terminals	2	MP 1x2 GDT+24V-Ad-Ad ST	97 00 20	72
	Screw terminals	2	MP RK GDT+24V-Ad-Pg	97 10 13	87
	Screw terminals	2	MP RK 24V-Ad-Pg	97 10 34	90
4-20 mA	Screw terminals	4	MP 2x2 GDT+24V-Ad-Ad ST	97 00 13	87
(also with HART) acc. to NAMUR recom-	Screw terminals	2	MP 1x2 GDT+24V-Ad-Ad ST	97 00 20	72
mendation NE 21 or acc. to EN 61000-4-5,	Screw terminals	2	MP RK GDT+24V-Ad-Ad	97 10 06	86
Open-circuit voltage 1 kV Ad-Pg	LSA	2	DP 1LSA-24	24 00 34	108
	LSA	20	DP 10LSA-24V	24 00 27	113
3/4-Signal Measurement	Screw terminals	4	MP 2x2 GDT+24V-Ad-Pg ST	97 00 27	74
ADVANT	Screw terminals	4	MP 2x2 GDT+5V-Ad-Ad-Pg ST	97 00 39	77
	Screw terminals	2	MP 1x2 GDT+5V-Ad-Ad-Pg ST	97 00 46	78
	Screw terminals	2	MP RK GDT+5V-Ad-Ad-Pg	97 10 18	85
Binary signals	Screw terminals	4	MP 2x2 GDT+XXV-Ad-Pg ST	97 00 25 - 97 00 31	74-75
	Screw terminals	2	MP 1x2 GDT+XXV-Ad-Pg ST	97 00 32 - 97 00 38	75-76
	Screw terminals	2	MP RK GDT+XXV-Ad-Pg	97 10 11 - 97 10 17	87-88
	Screw terminals	2	MP RK XXV-Ad-Pg	97 10 32 - 97 10 38	90
	LSA	2	DP 1LSA-XX	24 00 31 - 24 00 39	108-109
	LSA	20	DP 10LSA-24V	24 00 27	113
Bitbus	Screw terminals	4	MP 2x2 5V-HF ST	97 10 50	80
	Screw terminals	2	MP 1x2 5V-HF ST	97 10 52	80
BLN	Screw terminals	4	MP 2x2 GDT+12V-Ad-Ad ST	97 00 12	71
(Building Level Netzwerk)	Screw terminals	4	MP 2x2 GDT+48V-Ad-Ad ST	97 00 15	72
	Screw terminals	2	MP 1x2 GDT+12V-Ad-Ad ST	97 00 19	72
	Screw terminals	2	MP 1x2 GDT+48V-Ad-Ad ST	97 00 22	73
	Screw terminals	2	MP RK GDT+12V-Ad-Ad	97 10 05	86
	Screw terminals	2	MP RK GDT+48V-Ad-Ad	97 10 08	87
CAN-Bus	Screw terminals	4	MP 2x2 5V-HF ST	97 10 50	80
(data line only)	Screw terminals	2	MP 1x2 5V-HF ST	97 10 52	80
C-Bus	Screw terminals	4	MP 2x2 5V-HF ST	97 10 50	80
(Honeywell)	Screw terminals	2	MP 1x2 5V-HF ST	97 10 52	80
Data Highway Plus	Screw terminals	4	MP 2x2 GDT+12V-Ad-Ad ST	97 00 12	71
	Screw terminals	2	MP 1x2 GDT+12V-Ad-Ad ST	97 00 19	72
Delta Net Peer Bus	Screw terminals	4	MP 2x2 5V-HF ST	97 10 50	80
	Screw terminals	2	MP 1x2 5V-HF ST	97 10 52	80
Device Net	Screw terminals	4	MP 2x2 5V-HF ST	97 10 50	80
(data line only)	Screw terminals	2	MP 1x2 5V-HF ST	97 10 52	80
Dupline	Screw terminals	2	MP 1x2 GDT+24V-Ad-Ad ST	97 00 20	72
E-Bus	Screw terminals	4	MP 2x2 GDT+48V-Ad-Ad ST	97 00 15	72
(Honeywell)	Screw terminals	2	MP 1x2 GDT+48V-Ad-Ad ST	97 00 22	73
EIB	Screw terminals	4	MP 2x2 GDT ST	97 00 07	70
	Screw terminals	2	MP 1x2 GDT ST	97 00 10	70
	Screw terminals	2	MP RK GDT	97 10 03	84
	LSA	20	TelPro LSA-3EH230F1E-10kA	24 01 23	105
Electro acoustic system (ELA)	Screw terminals	4	MP 2x2 GDT ST	97 00 07	70
	Screw terminals	2	MP 1x2 GDT ST	97 00 10	70
	Screw terminals	2	MP RK GDT	97 10 03	84
	Screw terminals	4	MP 2x2 GDT+170V-Ad-Pg ST	97 00 31	75
	Screw terminals	2	MP 1x2 GDT+170V-Ad-Pg ST	97 00 38	76
	Screw terminals	2	MP RK GDT+170V-Ad-Pg	97 10 17	88
	LSA	2	DP 1LSA-110	24 00 39	109



Interface / Signal	Connection	Protected lines	Protection device	Article-No.	Page
	LSA	20	DP 10LSA-110	24 01 40	103
ET 200	Screw terminals	4	MP 2x2 5V-HF ST	97 10 50	80
	Screw terminals	2	MP 1x2 5V-HF ST	97 10 52	80
Fieldbus Foundation	Screw terminals	4	MP 2x2 GDT+24V-Ad-Ad ST	97 00 13	87
	Screw terminals	2	MP 1x2 GDT+24V-Ad-Ad ST	97 00 20	72
	Screw terminals	2	MP RK GDT+24V-Ad-Ad	97 10 06	86
	LSA	20	DP 10LSA-24V	24 00 27	113
FIPIO / FIPWAY	Screw terminals	4	MP 2x2 GDT+24V-Ad-Ad ST	97 00 13	87
	Screw terminals	2	MP 1x2 GDT+24V-Ad-Ad ST	97 00 20	72
	Screw terminals	2	MP RK GDT+24V-Ad-Ad	97 10 06	86
FIP I/O	Screw terminals	4	MP 2x2 5V-HF ST	97 10 50	80
	Screw terminals	2	MP 1x2 5V-HF ST	97 10 52	80
FSK	Screw terminals	4	MP 2x2 5V-HF ST	97 10 50	80
	Screw terminals	2	MP 1x2 5V-HF ST	97 10 52	80
Genius I/O Bus	Screw terminals	4	MP 2x2 GDT+12V-Ad-Ad ST	97 00 12	71
	Screw terminals	2	MP 1x2 GDT+12V-Ad-Ad ST	97 00 19	72
	Screw terminals	2	MP RK GDT+12V-Ad-Ad	97 10 05	86
DC power supply +24/30 V	Screw terminals	2	DP2x1-RLC/50V-Tr	28 70 50	142
IEC-Bus (RS 486)	Screw terminals	4	MP 2x2 5V-HF ST	97 10 50	80
	Screw terminals	2	MP 1x2 5V-HF ST	97 10 52	80
Industrial Ethernet	RJ45	8	DP RJ45-CAT6-48V-Tr	24 00 05	98
	RJ45	8	DP RJ45 f/f	24 00 11	99
	RJ45	8	DP 1xRJ45-PoE-Alu	24 00 21	99
	RJ45	8 x 8	DP 8xRJ45-6V-WG	19 40 50	101
	RJ45	8 x 8	DP 1x8RJ45-19"	19 40 13	100
	RJ45	16 x 8	DP 2x8RJ45-19"	19 40 23	100
	RJ45	24 x 8	DP 3x8RJ45-19"	19 40 33	100
	RJ45	32 x 8	DP 4x8RJ45-19"	19 40 43	100
	RJ45	40 x 8	DP 5x8RJ45-19"	19 40 53	101
	RJ45	48 x 8	DP 6x8RJ45-19"	19 40 63	101
INTERBUS-INLINE (I/O)	Screw terminals	4	MP 2x2 GDT+48V-Ad-Ad ST	97 00 15	72
	Screw terminals	2	MP 1x2 GDT+48V-Ad-Ad ST	97 00 22	73
	Screw terminals	2	MP RK GDT+48V-Ad-Ad	97 10 08	87
INTERBUS-Loop	Screw terminals	2	MP RK 24V-Ad-Pg	97 10 34	90
Interbus INLINE Fernbus	Screw terminals	4	MP 2x2 5V-HF ST	97 10 50	80
	Screw terminals	2	MP 1x2 5V-HF ST	97 10 52	80
K-Bus	Screw terminals	4	MP 2x2 GDT+24V-Ad-Ad ST	97 00 13	87
	Screw terminals	2	MP 1x2 GDT+24V-Ad-Ad ST	97 00 20	72
	Screw terminals	2	MP RK GDT+24V-Ad-Ad	97 10 06	86
KBR-Energy bus	Screw terminals	4	MP 2x2 5V-HF ST	97 10 50	80
	Screw terminals	2	MP 1x2 5V-HF ST	97 10 52	80
KNX-Bus	Screw terminals	4	MP 2x2 GDT ST	97 00 07	70
	Screw terminals	2	MP 1x2 GDT ST	97 00 10	70
	Screw terminals	2	MP RK GDT	97 10 03	84
	LSA	20	TelPro LSA-3EH230F1E-10kA	24 01 23	105
LON					
- TP/XF 78	Screw terminals	4	MP 2x2 GDT+5V-Ad-Ad ST	97 00 11	71
	Screw terminals	2	MP 1x2 GDT+5V-Ad-Ad ST	97 00 18	72
	Screw terminals	2	MP RK GDT+5V-Ad-Ad	97 10 04	86



SURGE PROTECTION FOR MEASURING SYSTEMS AND AUTOMATIC CONTROL DEVICES

SELECTION GUIDE

Interface / Signal	Connection	Protected lines	Protection device	Article-No.	Page
- TP/FTT10 und TP/LPT10	Screw terminals	4	MP 2x2 GDT+48V-Ad-Ad ST	97 00 15	72
	Screw terminals	2	MP 1x2 GDT+48V-Ad-Ad ST	97 00 22	73
	Screw terminals	2	MP RK GDT+48V-Ad-Ad	97 10 08	87
- TP/FTT 10	Screw terminals	4	MP 2x2 5V-HF ST	97 10 50	80
	Screw terminals	2	MP 1x2 5V-HF ST	97 10 52	80
LUXMATE-Bus	Screw terminals	4	MP 2x2 GDT+24V-Ad-Ad ST	97 00 13	87
	Screw terminals	2	MP 1x2 GDT+24V-Ad-Ad ST	97 00 20	72
	Screw terminals	2	MP RK GDT+24V-Ad-Ad	97 10 06	86
M-Bus	Screw terminals	4	MP 2x2 GDT+48V-Ad-Ad ST	97 00 15	72
	Screw terminals	2	MP 1x2 GDT+48V-Ad-Ad ST	97 00 22	73
	Screw terminals	2	MP RK GDT+48V-Ad-Ad	97 10 08	87
MODBUS	Screw terminals	4	MP 2x2 5V-HF ST	97 10 50	80
	Screw terminals	2	MP 1x2 5V-HF ST	97 10 52	80
MPI Bus	Screw terminals	4	MP 2x2 5V-HF ST	97 10 50	80
	Screw terminals	2	MP 1x2 5V-HF ST	97 10 52	80
N1 LAN	Screw terminals	4	MP 2x2 5V-HF ST	97 10 50	80
	Screw terminals	2	MP 1x2 5V-HF ST	97 10 52	80
N2 Bus (Johnson Controls, LON, FTT 10)	Screw terminals	4	MP 2x2 5V-HF ST	97 10 50	80
	Screw terminals	2	MP 1x2 5V-HF ST	97 10 52	80
Optocoupler Interface	Screw terminals	4	MP 2x2 GDT+24V-Ad-Ad-Pg ST	97 00 41	77
	Screw terminals	2	MP 1x2 GDT+24V-Ad-Ad-Pg ST	97 00 48	78
	Screw terminals	2	MP RK GDT+24V-Ad-Ad-Pg	97 10 20	85
Procontic SC31 (RS 232)	Screw terminals	2	MP 2x2 GDT+12V-Ad-Pg ST	97 00 26	74
Procontic T200 (RS 422)	Screw terminals	4	MP 2x2 5V-HF ST	97 10 50	80
PROFIBUS-DP/FMS	Screw terminals	4	MP 2x2 5V-HF ST	97 10 50	80
	Screw terminals	2	MP 1x2 5V-HF ST	97 10 52	80
PROFIBUS-PA	Screw terminals	4	MP 2x2 GDT+24V-Ad-Ad ST	97 00 13	87
	Screw terminals	2	MP 1x2 GDT+24V-Ad-Ad ST	97 00 20	72
	Screw terminals	2	MP RK GDT+24V-Ad-Ad	97 10 06	86
	LSA	2	DP 1LSA-C24FS-PTC	24 00 66	111
PROFIBUS SIMATIC NET	Screw terminals	4	MP 2x2 5V-HF ST	97 10 50	80
	Screw terminals	2	MP 1x2 5V-HF ST	97 10 52	80
PSM-EG-RS 422	Screw terminals	4	MP 2x2 5V-HF ST	97 10 50	80
	Screw terminals	2	MP 1x2 5V-HF ST	97 10 52	80
PSM-EG-RS 485	Screw terminals	4	MP 2x2 5V-HF ST	97 10 50	80
	Screw terminals	2	MP 1x2 5V-HF ST	97 10 52	80
Rackbus (RS 485)	Screw terminals	4	MP 2x2 5V-HF ST	97 10 50	80
	Screw terminals	2	MP 1x2 5V-HF ST	97 10 52	80
R-Bus	Screw terminals	4	MP 2x2 GDT+5V-Ad-Ad ST	97 00 11	71
	Screw terminals	2	MP 1x2 GDT+5V-Ad-Ad ST	97 00 18	72
	Screw terminals	2	MP RK GDT+5V-Ad-Ad	97 10 04	86
RS 485	Screw terminals	4	MP 2x2 5V-HF ST	97 10 50	80
	Screw terminals	2	MP 1x2 5V-HF ST	97 10 52	80
	LSA	2	DP 1LSA-C24FS-PTC	24 00 66	111
RS 422, V11	Screw terminals	4	MP 2x2 5V-HF ST	97 10 50	80
	Screw terminals	2	MP 1x2 5V-HF ST	97 10 52	80
S-Bus	Screw terminals	4	MP 2x2 5V-HF ST	97 10 50	80
	Screw terminals	2	MP 1x2 5V-HF ST	97 10 52	80
SafetyBUS p	Screw terminals	4	MP 2x2 5V-HF ST	97 10 50	80
	Screw terminals	2	MP 1x2 5V-HF ST	97 10 52	80



Interface / Signal	Connection	Protected lines	Protection device	Article-No.	Page
SDLC	Screw terminals	4	MP 2x2 5V-HF ST	97 10 50	80
	Screw terminals	2	MP 1x2 5V-HF ST	97 10 52	80
Securilan-LON-Bus (LONWORKS Technology)	Screw terminals	4	MP 2x2 GDT+5V-Ad-Ad ST	97 00 11	71
	Screw terminals	2	MP 1x2 GDT+5V-Ad-Ad ST	97 00 18	72
standard bus based on Echelon)	Screw terminals	2	MP RK GDT+5V-Ad-Ad	97 10 04	86
SIGMASYS (Siemens Fire alarm systems)	Screw terminals	4	MP 2x2 GDT+48V-Ad-Ad ST	97 00 15	72
	Screw terminals	2	MP 1x2 GDT+48V-Ad-Ad ST	97 00 22	73
	Screw terminals	2	MP RK GDT+48V-Ad-Ad	97 10 08	87
	Screw terminals	4	MP 2x2 GDT+48V-Ad-Pg ST	97 00 29	75
	Screw terminals	2	MP 1x2 GDT+48V-Ad-Pg ST	97 00 36	76
	Screw terminals	2	MP RK GDT+48V-Ad-Pg	97 10 15	88
SINEC L1	Screw terminals	4	MP 2x2 5V-HF ST	97 10 50	80
	Screw terminals	2	MP 1x2 5V-HF ST	97 10 52	80
SINEC L2	Screw terminals	4	MP 2x2 5V-HF ST	97 10 50	80
	Screw terminals	2	MP 1x2 5V-HF ST	97 10 52	80
SS97 SIN/X (RS 232)	Screw terminals	4	MP 2x2 GDT+12V-Ad-Pg ST	97 00 26	74
	Screw terminals	2	MP 1x2 GDT+12V-Ad-Pg ST	97 00 33	75
	Screw terminals	2	MP RK GDT+12V-Ad-Pg	97 10 12	87
SUCONET	Screw terminals	4	MP 2x2 GDT+5V-Ad-Ad ST	97 00 11	71
	Screw terminals	2	MP 1x2 GDT+5V-Ad-Ad ST	97 00 18	72
	Screw terminals	2	MP RK GDT+5V-Ad-Ad	97 10 04	86
Temperature measuring	Screw terminals	4	MP 2x2 GDT+5V-Ad-Pg ST	97 00 25	74
PT 100, PT 1000, Ni 1000, NTC, PTC	Screw terminals	2	MP 1x2 GDT+5V-Ad-Pg ST	97 00 32	75
	Screw terminals	2	MP RK GDT+5V-Ad-Pg	97 10 11	87
TTL	Screw terminals	4	MP 2x2 GDT+12V-Ad-Pg ST	97 00 26	74
	Screw terminals	2	MP 1x2 GDT+12V-Ad-Pg ST	97 00 33	75
	Screw terminals	2	MP RK GDT+12V-Ad-Pg	97 10 12	87
TTY 4 - 20 mA	Screw terminals	4	MP 2x2 GDT+24V-Ad-Pg ST	97 00 27	74
	Screw terminals	2	MP 1x2 GDT+24V-Ad-Pg ST	97 00 34	90
	Screw terminals	2	MP RK GDT+24V-Ad-Pg	97 10 13	87
	Screw terminals	2	MP RK 24V-Ad-Pg	97 10 34	90

Test Categories for SPDs in Information Technology acc. to table 3 of DIN EN 61643-21/VDE 0845-3-1: 2002

Category	Test type	Impulse voltage	Impuls current	Minimum number of impulses	Test for
C1	fast rising edge	0,5 kV or 1 kV (1,2/50 µs)	0,25 kA or 0,5 kA (8/20 µs)	300	Surge arrester
C2		2 kV, 4 kV or 10kV (1,2/50 µs)	1 kA, 2 kA or 5 kA (8/20 µs)	10	
C3		≥ 1 kV, 1 kV/µs	10A, 25 A or 100 A (10/1000 µs)	300	
D1	high energy	≥ 1 kV	0,5 kA, 1 kA or 2,5 kA (10/350 µs)	2	Lightning current combined arrester

Part 21: Product standard for surge protection devices for application in telecommunication and signal processing net works - performance requirements and test procedures.

According to the product standard DIN EN 61643-21 (VDE 0845 part 3-1:03-2002) all surge protection devices have to be tested during type tests with predefined minimum pulses according to the voltage and current pulses defined in table 3.

In doing so, the SPDs are classified into test categories with respect to their specification.

The category C represents disturbance pulses with steep rising edge and low energy level. The category D represents exposures to high energy levels, e.g. partial lightning currents.



Pluggable SPD with high discharge capability

MP 2x2 GDT ST / MP 1x2 GDT ST

Fully pluggable two-parts lightning current discharge arrester for signal lines. The protective module can be removed for test or maintenance purposes without changing the line impedance and therefore influencing the signal level. The base part can remain in the installation without manipulating or removing any wire.

- Protective circuit for 4 signal lines with common ground (MP2x2) and for 2 signal lines without reference to ground potential (MP1x2)
- Test standard: IEC 61643-21 / EN 61643-21
- Vibration and Shock according standard: DIN EN 60068-2-6 and DIN EN 60068-2-27
- Applicable at the boundaries LPZ 0B - 1 and higher
- Enclosure material: thermoplastic
- Space required for installation: 17.5 mm

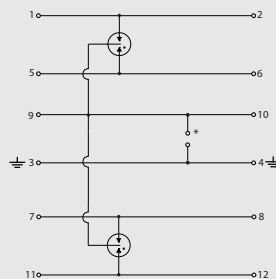

MP 2x2 GDT ST

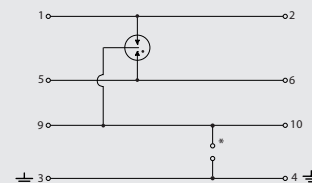

MP 1x2 GDT ST

Basic circuit diagram

MP2x2	2 Double lines		
	4 Single lines		
MP1x2	1 Double line		
	2 Single lines		
Technical Data	MP 2x2 GDT ST	MP 2x2 GDT ST-350	MP 1x2 GDT ST
Article-No.	97 00 07	97 00 08	97 00 10
IEC category/EN type	D1 / C2 / C1 / C3	D1 / C2 / C1 / C3	D1 / C2 / C1 / C3
Nominal voltage	UN 180 V	350 V	180 V
Max. continuous operating voltage (DC/AC)	Uc 180/120 V	350/255 V	180/120 V
Nominal current	IL 2 A	2 A	2 A
D1 lightning impulse current (10/350) per wire	Iimp 2,5 kA	2,5 kA	2,5 kA
C2 nominal discharge current (8/20 μs) total	I _{max} 20 kA	20 kA	20 kA
C2 nominal discharge current (8/20 μs) per line	I _n 10 kA	10 kA	10 kA
Protection level line-line at Iimp D1	Up ≤ 550 V	≤ 550 V	≤ 550 V
Protection level line-earth at Iimp D1	Up ≤ 550 V	≤ 550 V	≤ 550 V
Protection level line-line at 1 kV/μs C3	Up ≤ 500 V	≤ 500 V	≤ 500 V
Protection level line-earth at 1 kV/μs C3	Up ≤ 500 V	≤ 500 V	≤ 500 V
Series resistance per line	Rs 0 Ω	0 Ω	0 Ω
Max. operating frequency (-3 dB)	fG typ. 100 MHz	typ. 100 MHz	typ. 100 MHz
Conductor cross section (solid/stranded/AWG)	0.2-4.0/0.2-2.5 mm ² / 24-12	0.2-4.0/0.2-2.5 mm ² / 24-12	0.2-4.0/0.2-2.5 mm ² / 24-12
Operating temperature range	TU -40 - +80 °C	-40 - +80 °C	-40 - +80 °C
Inflammability class according to UL 94	V0	V0	V0
Degree of protection (IEC EN 60529)	IP 20	IP 20	IP 20

Accessories: Plug-in socket (Base)	for MP 2x2 GDT ST			for MP 1x2 GDT ST		
		MP Base 2x2	MP Base 2x2 GDT	MP Base 2x2 GND	MP Base 1x2	MP Base 1x2 GDT
Article-No.	97 00 03	97 00 04	97 00 92	97 00 97	97 00 98	97 00 94

Different base parts provide either direct or indirect earthing of the signal: The MP Base 2x2 (1x2) is not connected to 9/10 of DIN rail linked (galvanic insulation). The MP Base 2x2 (1x2) GDT has a gas discharge tube linked between the connectors 9/10 and the DIN

rail and earth connector. Therefore a galvanic insulation between the signal line and the earth connection (PE) can be reached. The MP Base 2x2 (1x2) GND is connected by a bridge to DIN rail (no galvanic insulation).





Pluggable SPD with high discharge capability and low protection level

MP 2x2 GDT/Ad-Ad ST / MP 1x2 GDT/Ad-Ad ST

Fully pluggable two-parts lightning current discharge arrester for signal lines. The protective module can be removed for test or maintenance purposes without changing the line impedance and therefore influencing the signal level. The base part can remain in the installation without manipulating or removing any wire.

- Protective circuit for 4 signal lines with common ground (MP2x2) and for 2 signal lines without reference to ground potential (MP1x2)
- Test standard: IEC 61643-21 / EN 61643-21
- Vibration and Shock according standard: DIN EN 60068-2-6 and DIN EN 60068-2-27
- Applicable at the boundaries LPZ 0B - 1 and higher
- Enclosure material: thermoplastic
- Space required for installation: 17.5 mm

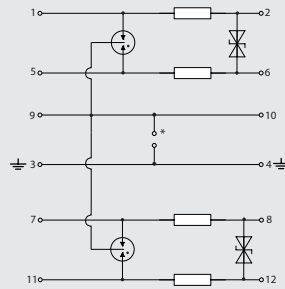

MP 2x2 GDT/Ad-Ad ST

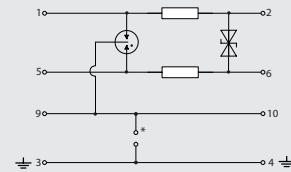

MP 1x2 GDT/Ad-Ad ST

Basic circuit diagram

MP2x2 2 Double lines 4 Single lines				
	MP 2x2 GDT+5V-Ad-Ad ST	MP 2x2 GDT+12V-Ad-Ad ST	MP 2x2 GDT+24V-Ad-Ad ST	MP 2x2 GDT+36V-Ad-Ad ST
Technical Data	MP 2x2 GDT+5V-Ad-Ad ST	MP 2x2 GDT+12V-Ad-Ad ST	MP 2x2 GDT+24V-Ad-Ad ST	MP 2x2 GDT+36V-Ad-Ad ST
Article-No.	97 00 11	97 00 12	97 00 13	97 00 14
IEC category/EN type	D1 / C2 / C1 / C3	D1 / C2 / C1 / C3	D1 / C2 / C1 / C3	D1 / C2 / C1 / C3
Nominal voltage	UN 5 V	12 V	24 V	36 V
Max. continuous operating voltage (DC/AC)	Uc 6/4 V	15/11 V	33/23 V	45/32 V
Nominal current	IL 0,5 A	0,5 A	0,5 A	0,5 A
D1 lightning impulse current (10/350) per wire	Iimp 2,5 kA	2,5 kA	2,5 kA	2,5 kA
C2 nominal discharge current (8/20 μs) total	I _{max} 20 kA	20 kA	20 kA	20 kA
C2 nominal discharge current (8/20 μs) per line	I _n 10 kA	10 kA	10 kA	10 kA
Protection level line-line at Iimp D1	Up ≤ 25 V	≤ 26 V	≤ 52 V	≤ 68 V
Protection level line-earth at Iimp D1	Up ≤ 550 V	≤ 550 V	≤ 550 V	≤ 550 V
Protection level line-line at 1 kV/μs C3	Up ≤ 10 V	≤ 19 V	≤ 45 V	≤ 58 V
Protection level line-earth at 1 kV/μs C3	Up ≤ 500 V	≤ 500 V	≤ 500 V	≤ 500 V
Series resistance per line	Rs 2,2 Ω	2,2 Ω	2,2 Ω	2,2 Ω
Max. operating frequency (-3 dB)	fG typ. 1,0 MHz	typ. 3,0 MHz	typ. 6,0 MHz	typ. 8,0 MHz
Conductor cross section (solid/stranded/AWG)	0.2-4.0/0.2-2.5 mm ² / 24-12	0.2-4.0/0.2-2.5 mm ² / 24-12	0.2-4.0/0.2-2.5 mm ² / 24-12	0.2-4.0/0.2-2.5 mm ² / 24-12
Operating temperature range	TU -40 - +80 °C	-40 - +80 °C	-40 - +80 °C	-40 - +80 °C
Inflammability class according to UL 94	V0	V0	V0	V0
Degree of protection (IEC EN 60529)	IP 20	IP 20	IP 20	IP 20

Accessories: Plug-in socket (Base) for MP 2x2-R			
	MP Base 2x2-R	MP Base 2x2-R GDT	MP Base 2x2-R GND
Article-No.	97 00 00	97 00 01	97 00 91

Different base parts provide either direct or indirect earthing of the signal: The MP Base 2x2-R is not connected to 9/10 of DIN rail linked (galvanic insulation). The MP Base 2x2-R GDT has a gas discharge tube linked between the connectors 9/10 and the DIN



rail and earth connector. Therefore a galvanic insulation between the signal line and the earth connection (PE) can be reached. The MP Base 2x2-R GND is connected by a bridge to DIN rail (no galvanic insulation).







SURGE PROTECTION FOR MEASURING SYSTEMS AND AUTOMATIC CONTROL DEVICES

PLUGGABLE SPD FOR MCR APPLICATIONS

MP2x2 2 Double lines 4 Single lines			
Technical Data	MP 2x2 GDT+48V-Ad-Ad ST	MP 2x2 GDT+60V-Ad-Ad ST	MP 2x2 GDT+170V-Ad-Ad ST
Article-No.	97 00 15	97 00 16	97 00 17
IEC category/EN type	D1 / C2 / C1 / C3	D1 / C2 / C1 / C3	D1 / C2 / C1 / C3
Nominal voltage	UN 48 V	60 V	170 V
Max. continuous operating voltage (DC/AC)	Uc 54/38 V	70/49 V	170/120 V
Nominal current	IL 0,5 A	0,5 A	0,5 A
D1 lightning impulse current (10/350) per wire	limp 2,5 kA	2,5 kA	2,5 kA
C2 nominal discharge current (8/20 μs) total	Imax 20 kA	20 kA	20 kA
C2 nominal discharge current (8/20 μs) per line	In 10 kA	10 kA	10 kA
Protection level line-line at limp D1	Up ≤ 80 V	≤ 110 V	≤ 270 V
Protection level line-earth at limp D1	Up ≤ 550 V	≤ 550 V	≤ 550 V
Protection level line-line at 1 kV/μs C3	Up ≤ 70 V	≤ 90 V	≤ 250 V
Protection level line-earth at 1 kV/μs C3	Up ≤ 500 V	≤ 500 V	≤ 500 V
Series resistance per line	Rs 2,2 Ω	2,2 Ω	2,2 Ω
Max. operating frequency (-3 dB)	fG typ. 10 MHz	typ. 12 MHz	typ. 25 MHz
Conductor cross section (solid/stranded/AWG)	0.2-4.0/0.2-2.5 mm ² / 24-12	0.2-4.0/0.2-2.5 mm ² / 24-12	0.2-4.0/0.2-2.5 mm ² / 24-12
Operating temperature range	TU -40 - +80 °C	-40 - +80 °C	-40 - +80 °C
Inflammability class according to UL 94	V0	V0	V0
Degree of protection (IEC EN 60529)	IP 20	IP 20	IP 20

MP1x2 1 Double line 2 Single lines				
Technical Data	MP 1x2 GDT+5V-Ad-Ad ST	MP 1x2 GDT+12V-Ad-Ad ST	MP 1x2 GDT+24V-Ad-Ad ST	MP 1x2 GDT+36V-Ad-Ad ST
Article-No.	97 00 18	97 00 19	97 00 20	97 00 21
IEC category/EN type	D1 / C2 / C1 / C3	D1 / C2 / C1 / C3	D1 / C2 / C1 / C3	D1 / C2 / C1 / C3
Nominal voltage	UN 5 V	12 V	24 V	36 V
Max. continuous operating voltage (DC/AC)	Uc 6/4 V	15/11 V	33/23 V	45/32 V
Nominal current	IL 0,5 A	0,5 A	0,5 A	0,5 A
D1 lightning impulse current (10/350) per wire	limp 2,5 kA	2,5 kA	2,5 kA	2,5 kA
C2 nominal discharge current (8/20 μs) total	Imax 20 kA	20 kA	20 kA	20 kA
C2 nominal discharge current (8/20 μs) per line	In 10 kA	10 kA	10 kA	10 kA
Protection level line-line at limp D1	Up ≤ 25 V	≤ 26 V	≤ 52 V	≤ 68 V
Protection level line-earth at limp D1	Up ≤ 550 V	≤ 550 V	≤ 550 V	≤ 550 V
Protection level line-line at 1 kV/μs C3	Up ≤ 10 V	≤ 19 V	≤ 45 V	≤ 58 V
Protection level line-earth at 1 kV/μs C3	Up ≤ 500 V	≤ 500 V	≤ 500 V	≤ 500 V
Series resistance per line	Rs 2,2 Ω	2,2 Ω	2,2 Ω	2,2 Ω
Max. operating frequency (-3 dB)	fG typ. 1,0 MHz	typ. 3,0 MHz	typ. 6,0 MHz	typ. 8,0 MHz
Conductor cross section (solid/stranded/AWG)	0.2-4.0/0.2-2.5 mm ² / 24-12	0.2-4.0/0.2-2.5 mm ² / 24-12	0.2-4.0/0.2-2.5 mm ² / 24-12	0.2-4.0/0.2-2.5 mm ² / 24-12
Operating temperature range	TU -40 - +80 °C	-40 - +80 °C	-40 - +80 °C	-40 - +80 °C
Inflammability class according to UL 94	V0	V0	V0	V0
Degree of protection (IEC EN 60529)	IP 20	IP 20	IP 20	IP 20

Dimension drawing, see pages 194 to 198

MP1x2 1 Double line 2 Single lines



Technical Data	MP 1x2 GDT+48V-Ad-Ad ST 97 00 22	MP 1x2 GDT+60V-Ad-Ad ST 97 00 23	MP 1x2 GDT+170V-Ad-Ad ST 97 00 24
IEC category/EN type	D1 / C2 / C1 / C3	D1 / C2 / C1 / C3	D1 / C2 / C1 / C3
Nominal voltage	UN 48 V	60 V	170 V
Max. continuous operating voltage (DC/AC)	Uc 54/38 V	70/49 V	170/120 V
Nominal current	IL 0,5 A	0,5 A	0,5 A
D1 lightning impulse current (10/350) per wire	limp 2,5 kA	2,5 kA	2,5 kA
C2 nominal discharge current (8/20 μs) total	Imax 20 kA	20 kA	20 kA
C2 nominal discharge current (8/20 μs) per line	In 10 kA	10 kA	10 kA
Protection level line-line at limp D1	Up ≤ 80 V	≤ 110 V	≤ 270 V
Protection level line-earth at limp D1	Up ≤ 550 V	≤ 550 V	≤ 550 V
Protection level line-line at 1 kV/μs C3	Up ≤ 70 V	≤ 90 V	≤ 250 V
Protection level line-earth at 1 kV/μs C3	Up ≤ 500 V	≤ 500 V	≤ 500 V
Series resistance per line	Rs 2,2 Ω	2,2 Ω	2,2 Ω
Max. operating frequency (-3 dB)	fG typ. 10 MHz	typ. 12 MHz	typ. 25 MHz
Conductor cross section (solid/stranded/AWG)	0.2-4.0/0.2-2.5 mm ² / 24-12	0.2-4.0/0.2-2.5 mm ² / 24-12	0.2-4.0/0.2-2.5 mm ² / 24-12
Operating temperature range	TU -40 - +80 °C	-40 - +80 °C	-40 - +80 °C
Inflammability class according to UL 94	V0	V0	V0
Degree of protection (IEC EN 60529)	IP 20	IP 20	IP 20

Accessories: Plug-in socket (Base) for MP 1x2 GDT	MP Base 1x2-R	MP Base 1x2-R GDT	MP Base 1x2-R GND
Article-No.	97 00 95	97 00 96	97 00 93



Different base parts provide either direct or indirect earthing of the signal: The MP Base 1x2-R is not connected to 9/10 of DIN rail linked (galvanic insulation). The MP Base 1x2-R GDT has a gas discharge tube linked between the connectors 9/10 and the DIN

rail and earth connector. Therefore a galvanic insulation between the signal line and the earth connection (PE) can be reached. The MP Base 1x2-R GND is connected by a bridge to DIN rail (no galvanic insulation).

Accessorie MP and DataPro series	EMV-FKL
Article-No.	26 09 90



EMC spring terminal for protected and unprotected side of Leutron Data or DataPro series



Pluggable SPD with high discharge capability and low protection level

MP 2x2 GDT/Ad-Pg ST / MP 1x2 GDT/Ad-Pg ST

Fully pluggable two-parts lightning current discharge arrester for signal lines. The protective module can be removed for test or maintenance purposes without changing the line impedance and therefore influencing the signal level. The base part can remain in the installation without manipulating or removing any wire.

- Protective circuit for 4 signal lines with common ground (MP2x2) and for 2 signal lines without reference to ground potential (MP1x2)
- Test standard: IEC 61643-21 / EN 61643-21
- Vibration and Shock according standard: DIN EN 60068-2-6 and DIN EN 60068-2-27
- Applicable at the boundaries LPZ 0B-1 and higher
- Enclosure material: thermoplastic
- Space required for installation: 17.5 mm

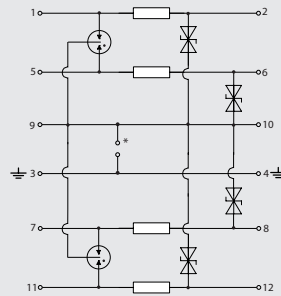

MP 2x2 GDT/Ad-Pg ST

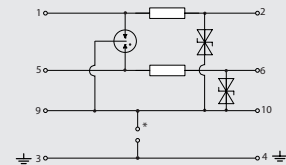

MP 1x2 GDT/Ad-Pg ST

Basic circuit diagram

MP2x2 2 Double lines 4 Single lines				
Technical Data	MP 2x2 GDT+5V-Ad-Pg ST	MP 2x2 GDT+12V-Ad-Pg ST	MP 2x2 GDT+24V-Ad-Pg ST	MP 2x2 GDT+36V-Ad-Pg ST
Article-No.	97 00 25	97 00 26	97 00 27	97 00 28
IEC category/EN type	D1 / C2 / C1 / C3	D1 / C2 / C1 / C3	D1 / C2 / C1 / C3	D1 / C2 / C1 / C3
Nominal voltage UN	5 V	12 V	24 V	36 V
Max. continuous operating voltage (DC/AC) Uc	6/4 V	15/11 V	33/23 V	45/32 V
Nominal current IL	0,5 A	0,5 A	0,5 A	0,5 A
D1 lightning impulse current (10/350) per wire Iimp	2,5 kA	2,5 kA	2,5 kA	2,5 kA
C2 nominal discharge current (8/20 μs) total Imax	20 kA	20 kA	20 kA	20 kA
C2 nominal discharge current (8/20 μs) per line In	10 kA	10 kA	10 kA	10 kA
Protection level line-line at Iimp D1 Up	≤ 29 V	≤ 50 V	≤ 102 V	≤ 135 V
Protection level line-earth at Iimp D1 Up	≤ 27 V	≤ 37 V	≤ 66 V	≤ 85 V
Protection level line-line at 1 kV/μs C3 Up	≤ 20 V	≤ 38 V	≤ 90 V	≤ 116 V
Protection level line-earth at 1 kV/μs C3 Up	≤ 10 V	≤ 19 V	≤ 45 V	≤ 58 V
Series resistance per line Rs	2,2 Ω	2,2 Ω	2,2 Ω	2,2 Ω
Max. operating frequency (-3 dB) fG	typ. 1,0 MHz	typ. 3,0 MHz	typ. 6,0 MHz	typ. 8,0 MHz
Conductor cross section (solid/stranded/AWG)	0.2-4.0/0.2-2.5 mm ² / 24-12	0.2-4.0/0.2-2.5 mm ² / 24-12	0.2-4.0/0.2-2.5 mm ² / 24-12	0.2-4.0/0.2-2.5 mm ² / 24-12
Operating temperature range TU	-40 - +80 °C	-40 - +80 °C	-40 - +80 °C	-40 - +80 °C
Inflammability class according to UL 94	V0	V0	V0	V0
Degree of protection (IEC EN 60529)	IP 20	IP 20	IP 20	IP 20

Accessories: Plug-in socket (Base) for MP 2x2 GDT			
	MP Base 2x2-R	MP Base 2x2-R GDT	MP Base 2x2-R GND
Article-No.	97 00 00	97 00 01	97 00 91

Different base parts provide either direct or indirect earthing of the signal: The MP Base 2x2-R is not connected to 9/10 of DIN rail linked (galvanic insulation). The MP Base 2x2-R GDT has a gas discharge tube linked between the connectors 9/10 and the DIN

rail and earth connector. Therefore a galvanic insulation between the signal line and the earth connection (PE) can be reached. The MP Base 2x2-R GND is connected by a bridge to DIN rail (no galvanic insulation).









Dimension drawing, see pages 194 to 198

SURGE PROTECTION FOR MEASURING SYSTEMS AND AUTOMATIC CONTROL DEVICES

PLUGGABLE SPD FOR MCR APPLICATIONS



MP2x2 2 Double lines 4 Single lines			
Technical Data	MP 2x2 GDT+48V-Ad-Pg ST	MP 2x2 GDT+60V-Ad-Pg ST	MP 2x2 GDT+170V-Ad-Pg ST
Article-No.	97 00 29	97 00 30	97 00 31
IEC category/EN type	D1 / C2 / C1 / C3	D1 / C2 / C1 / C3	D1 / C2 / C1 / C3
Nominal voltage	UN 48 V	60 V	170 V
Max. continuous operating voltage (DC/AC)	Uc 54/38 V	70/49 V	170/120 V
Nominal current	IL 0,5 A	0,5 A	0,5 A
D1 lightning impulse current (10/350) per wire	limp 2,5 kA	2,5 kA	2,5 kA
C2 nominal discharge current (8/20 μs) total	Imax 20 kA	20 kA	20 kA
C2 nominal discharge current (8/20 μs) per line	In 10 kA	10 kA	10 kA
Protection level line-line at limp D1	Up ≤ 160 V	≤ 220 V	≤ 520 V
Protection level line-earth at limp D1	Up ≤ 95 V	≤ 125 V	≤ 300 V
Protection level line-line at 1 kV/μs C3	Up ≤ 140 V	≤ 180 V	≤ 500 V
Protection level line-earth at 1 kV/μs C3	Up ≤ 70 V	≤ 90 V	≤ 250 V
Series resistance per line	Rs 2,2 Ω	2,2 Ω	2,2 Ω
Max. operating frequency (-3 dB)	fG typ. 10 MHz	typ. 12 MHz	typ. 25 MHz
Conductor cross section (solid/stranded/AWG)	0.2-4.0/0.2-2.5 mm ² / 24-12	0.2-4.0/0.2-2.5 mm ² / 24-12	0.2-4.0/0.2-2.5 mm ² / 24-12
Operating temperature range	TU -40 - +80 °C	-40 - +80 °C	-40 - +80 °C
Inflammability class according to UL 94	V0	V0	V0
Degree of protection (IEC EN 60529)	IP 20	IP 20	IP 20

MP1x2 1 Double line 2 Single lines				
Technical Data	MP 1x2 GDT+5V-Ad-Pg ST	MP 1x2 GDT+12V-Ad-Pg ST	MP 1x2 GDT+24V-Ad-Pg ST	MP 1x2 GDT+36V-Ad-Pg ST
Article-No.	97 00 32	97 00 33	97 00 34	97 00 35
IEC category/EN type	D1 / C2 / C1 / C3	D1 / C2 / C1 / C3	D1 / C2 / C1 / C3	D1 / C2 / C1 / C3
Nominal voltage	UN 5 V	12 V	24 V	36 V
Max. continuous operating voltage (DC/AC)	Uc 6/4 V	15/11 V	33/23 V	45/32 V
Nominal current	IL 0,5 A	0,5 A	0,5 A	0,5 A
D1 lightning impulse current (10/350) per wire	limp 2,5 kA	2,5 kA	2,5 kA	2,5 kA
C2 nominal discharge current (8/20 μs) total	Imax 20 kA	20 kA	20 kA	20 kA
C2 nominal discharge current (8/20 μs) per line	In 10 kA	10 kA	10 kA	10 kA
Protection level line-line at limp D1	Up ≤ 29 V	≤ 50 V	≤ 102 V	≤ 135 V
Protection level line-earth at limp D1	Up ≤ 27 V	≤ 37 V	≤ 66 V	≤ 85 V
Protection level line-line at 1 kV/μs C3	Up ≤ 20 V	≤ 38 V	≤ 90 V	≤ 116 V
Protection level line-earth at 1 kV/μs C3	Up ≤ 10 V	≤ 19 V	≤ 45 V	≤ 58 V
Series resistance per line	Rs 2,2 Ω	2,2 Ω	2,2 Ω	2,2 Ω
Max. operating frequency (-3 dB)	fG typ. 1,0 MHz	typ. 3,0 MHz	typ. 6,0 MHz	typ. 8,0 MHz
Conductor cross section (solid/stranded/AWG)	0.2-4.0/0.2-2.5 mm ² / 24-12	0.2-4.0/0.2-2.5 mm ² / 24-12	0.2-4.0/0.2-2.5 mm ² / 24-12	0.2-4.0/0.2-2.5 mm ² / 24-12
Operating temperature range	TU -40 - +80 °C	-40 - +80 °C	-40 - +80 °C	-40 - +80 °C
Inflammability class according to UL 94	V0	V0	V0	V0
Degree of protection (IEC EN 60529)	IP 20	IP 20	IP 20	IP 20

Dimension drawing, see pages 194 to 198



SURGE PROTECTION FOR MEASURING SYSTEMS AND AUTOMATIC CONTROL DEVICES

PLUGGABLE SPD FOR MCR APPLICATIONS

MP1x2 1 Double line 2 Single lines



Technical Data	MP 1x2 GDT+48V-Ad-Pg ST	MP 1x2 GDT+60V-Ad-Pg ST	MP 1x2 GDT+170V-Ad-Pg ST
Article-No.	97 00 36	97 00 37	97 00 38
IEC category/EN type	D1 / C2 / C1 / C3	D1 / C2 / C1 / C3	D1 / C2 / C1 / C3
Nominal voltage	UN 48 V	60 V	170 V
Max. continuous operating voltage (DC/AC)	Uc 54/38 V	70/49 V	170/120 V
Nominal current	IL 0,5 A	0,5 A	0,5 A
D1 lightning impulse current (10/350) per wire	Iimp 2,5 kA	2,5 kA	2,5 kA
C2 nominal discharge current (8/20 μs) total	I _{max} 20 kA	20 kA	20 kA
C2 nominal discharge current (8/20 μs) per line	I _n 10 kA	10 kA	10 kA
Protection level line-line at Iimp D1	Up ≤ 160 V	≤ 220 V	≤ 520 V
Protection level line-earth at Iimp D1	Up ≤ 95 V	≤ 125 V	≤ 300 V
Protection level line-line at 1 kV/μs C3	Up ≤ 140 V	≤ 180 V	≤ 500 V
Protection level line-earth at 1 kV/μs C3	Up ≤ 70 V	≤ 90 V	≤ 250 V
Series resistance per line	Rs 2,2 Ω	2,2 Ω	2,2 Ω
Max. operating frequency (-3 dB)	fG typ. 10 MHz	typ. 12 MHz	typ. 25 MHz
Conductor cross section (solid/stranded/AWG)	0.2-4.0/0.2-2.5 mm ² / 24-12	0.2-4.0/0.2-2.5 mm ² / 24-12	0.2-4.0/0.2-2.5 mm ² / 24-12
Operating temperature range	TU -40 - +80 °C	-40 - +80 °C	-40 - +80 °C
Inflammability class according to UL 94	V0	V0	V0
Degree of protection (IEC EN 60529)	IP 20	IP 20	IP 20

Accessories: Plug-in socket (Base) for MP 1x2 GDT

	MP Base 1x2-R	MP Base 1x2-R GDT	MP Base 1x2-R GND
Article-No.	97 00 95	97 00 96	97 00 93



Different base parts provide either direct or indirect earthing of the signal: The MP Base 1x2-R is not connected to 9/10 of DIN rail linked (galvanic insulation). The MP Base 1x2-R GDT has a gas discharge tube linked between the connectors 9/10 and the DIN

rail and earth connector. Therefore a galvanic insulation between the signal line and the earth connection (PE) can be reached. The MP Base 1x2-R GND is connected by a bridge to DIN rail (no galvanic insulation).

Accessorie MP and DataPro series

	EMV-FKL
Article-No.	26 09 90

EMC spring terminal for protected and unprotected side of Leutron Data or DataPro series

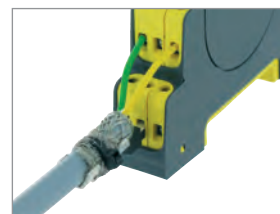

Dimension drawing, see pages 194 to 198



Pluggable SPD with high discharge capability and low protection level

MP 2x2 GDT/Ad-Ad-Pg ST / MP 1x2 GDT/Ad-Ad-Pg ST

Fully pluggable two-parts lightning current discharge arrester for signal lines. The protective module can be removed for test or maintenance purposes without changing the line impedance and therefore influencing the signal level. The base part can remain in the installation without manipulating or removing any wire.

- Protective circuit for 4 signal lines with common ground (MP2x2) and for 2 signal lines without reference to ground potential (MP1x2)
- Test standard: IEC 61643-21 / EN 61643-21
- Vibration and Shock according standard: DIN EN 60068-2-6 and DIN EN 60068-2-27
- Applicable at the boundaries LPZ 0B-2 and higher.
- Enclosure material: thermoplastic
- Space required for installation: 17.5 mm

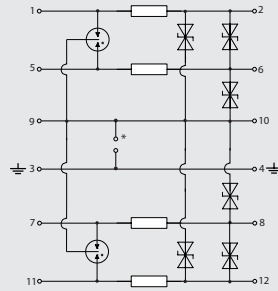

MP 2x2 GDT/Ad-Ad-Pg ST

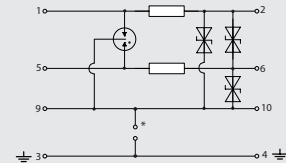

MP 1x2 GDT/Ad-Ad-Pg ST

Basic circuit diagram

MP2x2 2 Double lines 4 Single lines				
Technical Data	MP 2x2 GDT+5V-Ad-Ad-Pg ST	MP 2x2 GDT+12V-Ad-Ad-Pg ST	MP 2x2 GDT+24V-Ad-Ad-Pg ST	MP 2x2 GDT+36V-Ad-Ad-Pg ST
Article-No.	97 00 39	97 00 40	97 00 41	97 00 42
IEC category/EN type	D1 / C2 / C1 / C3	D1 / C2 / C1 / C3	D1 / C2 / C1 / C3	D1 / C2 / C1 / C3
Nominal voltage	UN 5 V	12 V	24 V	36 V
Max. continuous operating voltage (DC/AC)	Uc 6/4 V	15/11 V	33/23 V	45/32 V
Nominal current	IL 0,5 A	0,5 A	0,5 A	0,5 A
D1 lightning impulse current (10/350) per wire	Iimp 2,5 kA	2,5 kA	2,5 kA	2,5 kA
C2 nominal discharge current (8/20 µs) total	I _{max} 20 kA	20 kA	20 kA	20 kA
C2 nominal discharge current (8/20 µs) per line	I _n 10 kA	10 kA	10 kA	10 kA
Protection level line-line at Iimp D1	U _p ≤ 25 V	≤ 26 V	≤ 52 V	≤ 68 V
Protection level line-earth at Iimp D1	U _p ≤ 27 V	≤ 37 V	≤ 66 V	≤ 85 V
Protection level line-line at 1 kV/µs C3	U _p ≤ 10 V	≤ 19 V	≤ 45 V	≤ 58 V
Protection level line-earth at 1 kV/µs C3	U _p ≤ 10 V	≤ 19 V	≤ 45 V	≤ 58 V
Series resistance per line	R _s 2,2 Ω	2,2 Ω	2,2 Ω	2,2 Ω
Max. operating frequency (-3 dB)	f _G typ. 1,0 MHz	typ. 3,0 MHz	typ. 6,0 MHz	typ. 8,0 MHz
Conductor cross section (solid/stranded/AWG)	0.2-4.0/0.2-2.5 mm ² / 24-12	0.2-4.0/0.2-2.5 mm ² / 24-12	0.2-4.0/0.2-2.5 mm ² / 24-12	0.2-4.0/0.2-2.5 mm ² / 24-12
Operating temperature range	TU -40 - +80 °C	-40 - +80 °C	-40 - +80 °C	-40 - +80 °C
Inflammability class according to UL 94	V0	V0	V0	V0
Degree of protection (IEC EN 60529)	IP 20	IP 20	IP 20	IP 20

Accessories: Plug-in socket (Base) for MP 2x2 GDT	MP Base 2x2-R	MP Base 2x2-R GDT	MP Base 2x2-R GND
Article-No.	97 00 00	97 00 01	97 00 91

Different base parts provide either direct or indirect earthing of the signal: The MP Base 2x2-R is not connected to 9/10 of DIN rail linked (galvanic insulation). The MP Base 2x2-R GDT has a gas discharge tube linked between the connectors 9/10 and

the DIN rail and earth connector. Therefore a galvanic insulation between the signal line and the earth connection (PE) can be reached. The MP Base 2x2-R GND is connected by a bridge to DIN rail (no galvanic insulation).





Dimension drawing, see pages 194 to 198



SURGE PROTECTION FOR MEASURING SYSTEMS AND AUTOMATIC CONTROL DEVICES

PLUGGABLE SPD FOR MCR APPLICATIONS

MP2x2 2 Double lines 4 Single lines			
Technical Data	MP 2x2 GDT+48V-Ad-Ad-Pg ST	MP 2x2 GDT+60V-Ad-Ad-Pg ST	MP 2x2 GDT+170V-Ad-Ad-Pg ST
Article-No.	97 00 43	97 00 44	97 00 45
IEC category/EN type	D1 / C2 / C1 / C3	D1 / C2 / C1 / C3	D1 / C2 / C1 / C3
Nominal voltage	UN 48 V	60 V	170 V
Max. continuous operating voltage (DC/AC)	Uc 54/38 V	70/49 V	170/120 V
Nominal current	IL 0,5 A	0,5 A	0,5 A
D1 lightning impulse current (10/350) per wire	limp 2,5 kA	2,5 kA	2,5 kA
C2 nominal discharge current (8/20 μs) total	Imax 20 kA	20 kA	20 kA
C2 nominal discharge current (8/20 μs) per line	In 10 kA	10 kA	10 kA
Protection level line-line at limp D1	Up ≤ 80 V	≤ 110 V	≤ 270 V
Protection level line-earth at limp D1	Up ≤ 95 V	≤ 125 V	≤ 300 V
Protection level line-line at 1 kV/μs C3	Up ≤ 70 V	≤ 90 V	≤ 250 V
Protection level line-earth at 1 kV/μs C3	Up ≤ 70 V	≤ 90 V	≤ 250 V
Series resistance per line	Rs 2,2 Ω	2,2 Ω	2,2 Ω
Max. operating frequency (-3 dB)	fG typ. 10 MHz	typ. 12 MHz	typ. 25 MHz
Conductor cross section (solid/stranded/AWG)	0.2-4.0/0.2-2.5 mm ² / 24-12	0.2-4.0/0.2-2.5 mm ² / 24-12	0.2-4.0/0.2-2.5 mm ² / 24-12
Operating temperature range	TU -40 - +80 °C	-40 - +80 °C	-40 - +80 °C
Inflammability class according to UL 94	V0	V0	V0
Degree of protection (IEC EN 60529)	IP 20	IP 20	IP 20

MP1x2 1 Double line 2 Single lines				
Technical Data	MP 1x2 GDT+5V-Ad-Ad-Pg ST	MP 1x2 GDT+12V-Ad-Ad-Pg ST	MP 1x2 GDT+24V-Ad-Ad-Pg ST	MP 1x2 GDT+36V-Ad-Ad-Pg ST
Article-No.	97 00 46	97 00 47	97 00 48	97 00 49
IEC category/EN type	D1 / C2 / C1 / C3	D1 / C2 / C1 / C3	D1 / C2 / C1 / C3	D1 / C2 / C1 / C3
Nominal voltage	UN 5 V	12 V	24 V	36 V
Max. continuous operating voltage (DC/AC)	Uc 6/4 V	15/11 V	33/23 V	45/32 V
Nominal current	IL 0,5 A	0,5 A	0,5 A	0,5 A
D1 lightning impulse current (10/350) per wire	limp 2,5 kA	2,5 kA	2,5 kA	2,5 kA
C2 nominal discharge current (8/20 μs) total	Imax 20 kA	20 kA	20 kA	20 kA
C2 nominal discharge current (8/20 μs) per line	In 10 kA	10 kA	10 kA	10 kA
Protection level line-line at limp D1	Up ≤ 25 V	≤ 26 V	≤ 52 V	≤ 68 V
Protection level line-earth at limp D1	Up ≤ 27 V	≤ 37 V	≤ 66 V	≤ 85 V
Protection level line-line at 1 kV/μs C3	Up ≤ 10 V	≤ 19 V	≤ 45 V	≤ 58 V
Protection level line-earth at 1 kV/μs C3	Up ≤ 10 V	≤ 19 V	≤ 45 V	≤ 58 V
Series resistance per line	Rs 2,2 Ω	2,2 Ω	2,2 Ω	2,2 Ω
Max. operating frequency (-3 dB)	fG typ. 1,0 MHz	typ. 3,0 MHz	typ. 6,0 MHz	typ. 8,0 MHz
Conductor cross section (solid/stranded/AWG)	0.2-4.0/0.2-2.5 mm ² / 24-12	0.2-4.0/0.2-2.5 mm ² / 24-12	0.2-4.0/0.2-2.5 mm ² / 24-12	0.2-4.0/0.2-2.5 mm ² / 24-12
Operating temperature range	TU -40 - +80 °C	-40 - +80 °C	-40 - +80 °C	-40 - +80 °C
Inflammability class according to UL 94	V0	V0	V0	V0
Degree of protection (IEC EN 60529)	IP 20	IP 20	IP 20	IP 20

Dimension drawing, see pages 194 to 198



MP1x2 1 Double line 2 Single lines



Technical Data	MP 1x2 GDT+48V-Ad-Ad-Pg ST	MP 1x2 GDT+60V-Ad-Ad-Pg ST	MP 1x2 GDT+170V-Ad-Ad-Pg ST
Article-No.	97 00 50	97 00 51	97 00 52
IEC category/EN type	D1 / C2 / C1 / C3	D1 / C2 / C1 / C3	D1 / C2 / C1 / C3
Nominal voltage	UN 48 V	60 V	170 V
Max. continuous operating voltage (DC/AC)	Uc 54/38 V	70/49 V	170/120 V
Nominal current	IL 0,5 A	0,5 A	0,5 A
D1 lightning impulse current (10/350) per wire	limp 2,5 kA	2,5 kA	2,5 kA
C2 nominal discharge current (8/20 μs) total	Imax 20 kA	20 kA	20 kA
C2 nominal discharge current (8/20 μs) per line	In 10 kA	10 kA	10 kA
Protection level line-line at limp D1	Up ≤ 80 V	≤ 110 V	≤ 270 V
Protection level line-earth at limp D1	Up ≤ 95 V	≤ 125 V	≤ 300 V
Protection level line-line at 1 kV/μs C3	Up ≤ 70 V	≤ 90 V	≤ 250 V
Protection level line-earth at 1 kV/μs C3	Up ≤ 70 V	≤ 90 V	≤ 250 V
Series resistance per line	Rs 2,2 Ω	2,2 Ω	2,2 Ω
Max. operating frequency (-3 dB)	fG typ. 10 MHz	typ. 12 MHz	typ. 25 MHz
Conductor cross section (solid/stranded/AWG)	0.2-4.0/0.2-2.5 mm ² / 24-12	0.2-4.0/0.2-2.5 mm ² / 24-12	0.2-4.0/0.2-2.5 mm ² / 24-12
Operating temperature range	TU -40 - +80 °C	-40 - +80 °C	-40 - +80 °C
Inflammability class according to UL 94	V0	V0	V0
Degree of protection (IEC EN 60529)	IP 20	IP 20	IP 20

Accessories: Plug-in socket (Base) for MP 1x2 GDT	MP Base 1x2-R	MP Base 1x2-R GDT	MP Base 1x2-R GND
Article-No.	97 00 95	97 00 96	97 00 93



Different base parts provide either direct or indirect earthing of the signal: The MP Base 1x2-R is not connected to 9/10 of DIN rail linked (galvanic insulation). The MP Base 1x2-R GDT has a gas discharge tube linked between the connectors 9/10 and the DIN

rail and earth connector. Therefore a galvanic insulation between the signal line and the earth connection (PE) can be reached. The MP Base 1x2-R GND is connected by a bridge to DIN rail (no galvanic insulation).

Accessorie MP and DataPro series	EMV-FKL
Article-No.	26 09 90

EMC spring terminal for protected and unprotected side of Leutron Data or DataPro series.





Pluggable SPD for high frequency MCR applications

MP 2x2 HF ST / MP 1x2 HF ST

Fully pluggable two-parts combined surge arrester for signal lines for high frequency applications such as bus systems or video transmission. The protective module can be removed for test or maintenance purposes without changing the line impedance and therefore influencing the signal level. The base part can remain in the installation without manipulating or removing any wire.

- Max. operating frequency: 70 MHz
- Nominal current: 0,5 A
- Test standard: IEC 61643-21 / EN 61643-21
- Vibration and Shock according standard: DIN EN 60068-2-6 and DIN EN 60068-2-27
- Mounting on 35 mm DIN rail
- Enclosure material: thermoplastic
- Space required for installation: 17,5 mm
- Applicable at the boundaries LPZ OB - 1 and higher

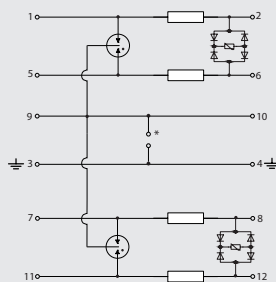

MP 2x2 HF ST

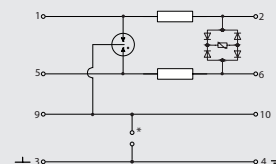

MP 1x2 HF ST

Basic circuit diagram

	MP2x2	2 Double lines	4 Single lines		MP1x2	1 Double line	2 Single lines
Technical Data		MP 2x2 5V-HF ST	MP 2x2 24V-HF ST		MP 1x2 5V-HF ST	MP 1x2 24V-HF ST	
Article-No.		97 10 50	97 10 51		97 10 52	97 10 53	
IEC category/EN type		D1 / C2 / C1 / C3	D1 / C2 / C1 / C3		D1 / C2 / C1 / C3	D1 / C2 / C1 / C3	
Nominal voltage	UN	5 V	24 V		5 V	24 V	
Max. continuous operating voltage (DC/AC)	Uc	6/4 V	33/23 V		6/4 V	33/23 V	
Nominal current	IL	0,5 A	0,5 A		0,5 A	0,5 A	
D1 lightning impulse current (10/350) per wire	Iimp	2,5 kA	2,5 kA		2,5 kA	2,5 kA	
C2 nominal discharge current (8/20 μs) total	I _{max}	20 kA	20 kA		20 kA	20 kA	
C2 nominal discharge current (8/20 μs) per line	I _n	10 kA	10 kA		10 kA	10 kA	
Protection level line-line at Iimp D1	Up	≤ 25 V	≤ 52 V		≤ 25 V	≤ 52 V	
Protection level line-earth at Iimp D1	Up	≤ 350 V	≤ 350 V		≤ 350 V	≤ 350 V	
Protection level line-line at 1 kV/μs C3	Up	≤ 10 V	≤ 45 V		≤ 10 V	≤ 45 V	
Protection level line-earth at 1 kV/μs C3	Up	≤ 450 V	≤ 450 V		≤ 450 V	≤ 450 V	
Series resistance per line	R _s	1,5 Ω	1,5 Ω		1,5 Ω	1,5 Ω	
Max. operating frequency (-3 dB)	f _G	typ. 70 MHz	typ. 70 MHz		typ. 70 MHz	typ. 70 MHz	
Conductor cross section (solid/stranded/AWG)	TU	0.2-4.0/0.2-2.5 mm ² / 24-12	0.2-4.0/0.2-2.5 mm ² / 24-12		0.2-4.0/0.2-2.5 mm ² / 24-12	0.2-4.0/0.2-2.5 mm ² / 24-12	
Operating temperature range	TU	-40 - +80 °C	-40 - +80 °C		-40 - +80 °C	-40 - +80 °C	
Inflammability class according to UL 94	V0	V0	V0		V0	V0	
Degree of protection (IEC EN 60529)	IP 20	IP 20	IP 20		IP 20	IP 20	

Accessories: Bases	for MP 2x2-HF ST			for MP 1x2-HF ST		
	MP Base 2x2-R HF	MP Base 2x2-R GDT HF	MP Base 2x2-R GND HF	MP Base 1x2-R HF	MP Base 1x2-R GDT HF	MP Base 1x2-R GND HF
Article-No.	97 00 99	97 01 00	97 01 01	97 01 02	97 01 03	97 01 04

Different base parts provide either direct or indirect earthing of the signal: The MP Base 2x2-R HF (1x2-R HF) is not connected to 9/10 of DIN rail linked (galvanic insulation). The MP Base 2x2-R HF (1x2-R HF) GDT has a gas discharge tube linked between the

connectors 9/10 and the DIN rail and earth connector. Therefore a galvanic insulation between the signal line and the earth connection (PE) can be reached. The MP Base 2x2-R HF (1x2-R HF) GND is connected by a bridge to DIN rail (no galvanic insulation).



Dimension drawing, see pages 194 to 198



MP 2x2-170 HF ST / MP 1x2-170 HF ST

Fully pluggable two-parts combined surge arrester for signal lines for high frequency applications such as bus systems or video transmission. The protective module can be removed for test or maintenance purposes without changing the line impedance and therefore influencing the signal level. The base part can remain in the installation without manipulating or removing any wire.

- Max. operating frequency: 170 MHz
- Nominal current: 1 A
- Test standard: IEC 61643-21 / EN 61643-21
- Vibration and Shock according standard: DIN EN 60068-2-6 and DIN EN 60068-2-27
- Mounting on 35 mm DIN rail
- Enclosure material: thermoplastic
- Space required for installation: 17.5 mm
- Applicable at the boundaries LPZ 0B - 1 and higher

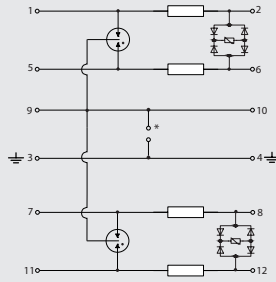

MP 2x2-170 HF ST

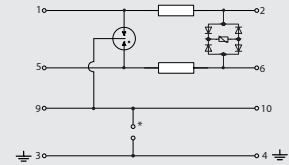

MP 1x2-170 HF ST

Basic circuit diagram

MP2x2 2 Double lines 4 Single lines MP1x2 1 Double line 2 Single lines				
Technical Data	MP 2x2 5V-170-HF ST	MP 2x2 24V-170-HF ST	MP 1x2 5V-170-HF ST	MP 1x2 24V-170-HF ST
Article-No.	97 10 54	97 10 55	97 10 56	97 10 57
IEC category/EN type	D1 / C2 / C1 / C3	D1 / C2 / C1 / C3	D1 / C2 / C1 / C3	D1 / C2 / C1 / C3
Nominal voltage	UN 5 V	24 V	5 V	24 V
Max. continuous operating voltage (DC/AC)	Uc 6/4 V	33/23 V	6/4 V	33/23 V
Nominal current	IL 1 A	1 A	1 A	1 A
D1 lightning impulse current (10/350) per wire	Iimp 2,5 kA	2,5 kA	2,5 kA	2,5 kA
C2 nominal discharge current (8/20 μs) total	I _{max} 20 kA	20 kA	20 kA	20 kA
C2 nominal discharge current (8/20 μs) per line	I _n 10 kA	10 kA	10 kA	10 kA
Protection level line-line at Iimp D1	Up ≤ 25 V	≤ 52 V	≤ 25 V	≤ 52 V
Protection level line-earth at Iimp D1	Up ≤ 350 V	≤ 350 V	≤ 350 V	≤ 350 V
Protection level line-line at 1 kV/μs C3	Up ≤ 10 V	≤ 45 V	≤ 10 V	≤ 45 V
Protection level line-earth at 1 kV/μs C3	Up ≤ 450 V	≤ 450 V	≤ 450 V	≤ 450 V
Series resistance per line	Rs 1,5 Ω	1,5 Ω	1,5 Ω	1,5 Ω
Max. operating frequency (-3 dB)	fG typ. 170 MHz	typ. 170 MHz	typ. 170 MHz	typ. 170 MHz
Conductor cross section (solid/stranded/AWG)	0.2-4.0/0.2-2.5 mm ² / 24-12	0.2-4.0/0.2-2.5 mm ² / 24-12	0.2-4.0/0.2-2.5 mm ² / 24-12	0.2-4.0/0.2-2.5 mm ² / 24-12
Operating temperature range	TU -40 - +80 °C	-40 - +80 °C	-40 - +80 °C	-40 - +80 °C
Inflammability class according to UL 94	V0	V0	V0	V0
Degree of protection (IEC EN 60529)	IP 20	IP 20	IP 20	IP 20

Accessories: Bases	for MP 2x2-170 HF ST			for MP 1x2-170 HF ST		
	MP Base 2x2-R HF	MP Base 2x2-R GDT HF	MP Base 2x2-R GND HF	MP Base 1x2-R HF	MP Base 1x2-R GDT HF	MP Base 1x2-R GND HF
Article-No.	97 00 99	97 01 00	97 01 01	97 01 02	97 01 03	97 01 04

Different base parts provide either direct or indirect earthing of the signal: The MP Base 2x2-R HF (1x2-R HF) is not connected to 9/10 of DIN rail linked (galvanic insulation). The MP Base 2x2-R HF (1x2-R HF) GDT has a gas discharge tube linked between the

connectors 9/10 and the DIN rail and earth connector. Therefore a galvanic insulation between the signal line and the earth connection (PE) can be reached. The MP Base 2x2-R HF (1x2-R HF) GND is connected by a bridge to DIN rail (no galvanic insulation).



Dimension drawing, see pages 194 to 198



One-piece SPD for MCR applications for high frequency

DataPro2x1-SDSL-Tr

Surge voltage arrester with a two-step circuit to protect two single wires in data and signal lines. The arrester is especially designed for 24 V SPS input lines. It is suited for high-frequency and very fast data transmission. The arrester is applicable at the LPZ transition point 0B-2 and higher. Alternatively, direct and indirect earthing is possible.

- High performance surge protector
- Lightning impulse current 5 kA (10/350 μs)
- Transfer rate 100 Mbit/s
- Max. nominal current 500 mA
- fG > 300 MHz

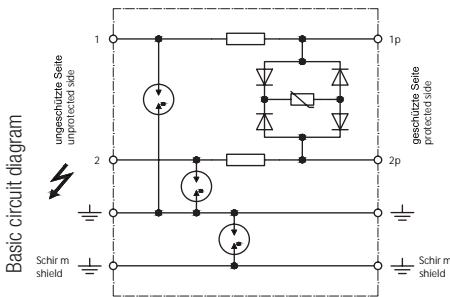

Technical Data	DataPro 2x1-SDSL-Tr	DataPro 2x1-24V-SDSL-Tr
Article-No.	24 00 18	24 00 24
Nominal voltage DC	UN 6 V=	24 V=
Nominal current	IL 0,5 A	0,5 A
C2 nominal discharge current (8/20 μs) total	Imax 20 kA	20 kA
C2 nominal discharge current (8/20 μs) per line	In 10 kA	10 kA
Protection level 1p-2p;1p,2p-PE (1kV/μs)	Up ≤ 0,6 kV	≤ 0,6 kV
Signal transmission rate	100 Mbit/s	100 Mbit/s
Max. operating frequency (-3 dB)	fG 300 MHz	300 MHz
Operating temperature range	TU - 25 - + 85 °C	- 25 - + 85 °C
Series resistance	0 Ω	0 Ω
Series inductance, typ.	L 0 μH	0 μH
Response time	tA ≤ 1 ns	≤ 1 ns
Max. conductor cross section	2.5mm ² solid or 1.5mm ² flexible with sleeve	2.5mm ² solid or 1.5mm ² flexible with sleeve
Degree of protection (IEC EN 60529)	IP 20	IP 20
Housing size W x H x D	17,5 x 87(90) x 58 mm	17,5 x 87(90) x 58 mm
Terminals	2,5 mm ²	2,5 mm ²
Mounting on	35 mm DIN DIN rail	35 mm DIN DIN rail

DataPro 4x1-SDSL-Tr

Surge voltage arrester with a two-step circuit to protect two pairs of wires or four single wires with signal common. High-resistance shield grounding via shield terminal possible.

- High performance surge protector
- Signal transmission rate 100 Mbit/s
- Max. nominal current 500 mA
- For fast dataline signals
- fG > 300 MHz

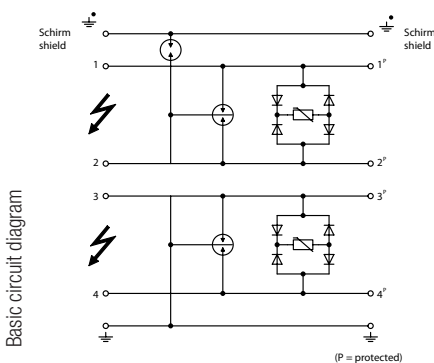

Technical Data	DataPro 4x1-SDSL-Tr
Article-No.	24 00 20
Nominal voltage DC	UN 6 V=
Nominal current	IL 0,5 A
C2 nominal discharge current (8/20 μs) total	Imax 20 kA
C2 nominal discharge current (8/20 μs) per line	In 10 kA
Protection level 1p-2p;1p,2p-PE (1kV/μs)	Up ≤ 0,6 kV
Signal transmission rate	100 Mbit/s
Max. operating frequency (-3 dB)	fG 300 MHz
Series resistance	0 Ω
Series inductance, typ.	L 0 μH
Response time	tA ≤ 1 ns
Terminals	2,5 mm ²
Mounting on	35 mm DIN rail,

Dimension drawing, see pages 194 to 198



DataPro-RS 485-Tr

SPD for RS 485 interface.

- Mounting on DIN rail 35 mm (DIN EN 50 022)

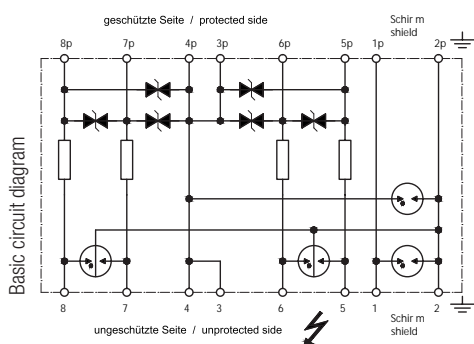

Technical Data		DP-RS 485-Tr
Article-No.		27 04 85
Nominal voltage DC	UN	5 V=
Max. continuous operating voltage DC	Uc	6 V=
Leakage current at Umax DC	IL	≤ 5 µA
Max. allowed operating current	IL	0,5 mA
Max. operating frequency (-3 dB)	fG	1000 kHz
Capacitance, line-earth	C	≤ 3 nF
DC resistance	R	1,8 Ω
Series inductance, typ.	L	10 µH
Protection level wire-wire	Up	≤ 8,5 V
Protection level (line-earth)	Up	≤ 600 V
Response time	tA	≤ 1 ns
Nominal discharge current (8/20µs)	In	20 kA
Max. conductor cross section		2.5mm ² solid or 1.5mm ² flexible with sleeve
Operating temperature range	TU	-25 - +85 °C
Enclosure material / colour		polycarbonate UL 94-V0/yellow
Casting compound		Polyurethan soft

Dimension drawing, see pages 194 to 198



One-piece SPD with high discharge capability

IsoProData-Tr

One-piece lightning current discharge arrester for signal lines with a discharge capability for use the at the building entry.

- Protection of one double or two single lines
- Applicable at the boundaries LPZ 0A - 1 and higher
- Test standard: IEC 61643-21 / EN 61643-21
- Space required for installation: 17,5 mm
- Mounting on 35 mm DIN rail
- Degree of protection according to IEC EN 60529: IP 20

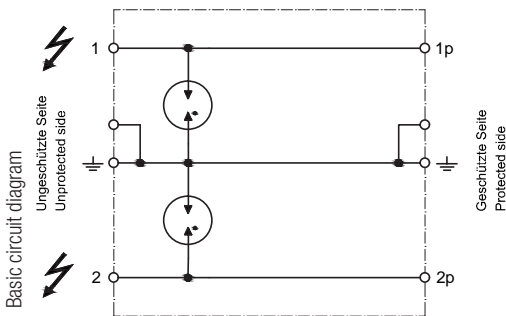

Technical Data		IsoProData-Tr
Article-No.		27 30 02
IEC category/EN type		D1 / C2 / C1 / C3
Nominal voltage DC	UN	150 V=
Max. continuous operating voltage DC	Uc	170 V=
Max. continuous operating voltage AC	Uc	120 V~
Nominal current	IL	1,5 A
Leakage current at Uc DC	IL	≤ 0.001 μA
Response time	tA	≤ 50 ns
C2 Nominal impulse discharge current (8/20)	In	20 kA
D1 Lightning impulse current (10/350) total	Itotal	10 kA
D1 lightning impulse current (10/350) per wire	Iimp	5 kA
Protection level, residual voltage line-earth at In resp. 1 kV/μs	Up	≤ 800 V
Capacitance, line-earth	C	< 0.005 nF
Insulation resistance	Risol	>10 GΩ
Operating temperature range	TU	-40 - +80 °C
Max. conductor cross section		2.5mm ² solid or 1.5mm ² flexible with sleeve
Installation dimensions (W × H × D)		17,5 x 87 x 58 mm
Enclosure material / colour		Polycarbonate UL 94-V0/yellow

MP RK GDT

Terminal blocks with integrated surge protection can optimize the used space in a control cabinet and at the same time provide high level protection for terminal equipment and devices.

- Protection of one double or two single lines
- Applicable at the boundaries LPZ 0B - 1 and higher
- Test standard: IEC 61643-21 / EN 61643-21
- Mounting on 35 mm DIN rail
- Space required for installation: 6,2 mm
- Earthing via DIN rail or connector

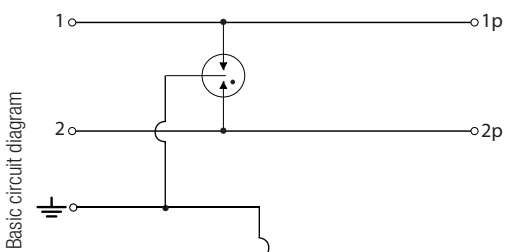

Technical Data		MP RK GDT
Article-No.		97 10 03
IEC category/EN type		C2 / C1 / C3
Nominal voltage	UN	180 V
Max. continuous operating voltage (DC/AC)	Uc	180/120 V
Nominal current	IL	2,0 A
C2 nominal discharge current (8/20 μs) total	I _{max}	10 kA
C2 nominal discharge current (8/20 μs) per line	I _n	5 kA
Protection level line-line at In C2	Up	≤ 500 V
Protection level line-earth at In C2	Up	≤ 500 V
Protection level line-line at 1 kV/μs C3	Up	≤ 500 V
Protection level line-earth at 1 kV/μs C3	Up	≤ 500 V
Series resistance per line	Rs	0 Ω
Max. operating frequency (-3 dB)	fG	typ. 100 MHz
Conductor cross section (solid/stranded/AWG)		0.2-4.0/0.2-2.5 mm ² / 24-12
Operating temperature range	TU	-40 - +80 °C
Inflammability class according to UL 94		V0
Degree of protection (IEC EN 60529)		IP 20
Enclosure material / colour		PA6 / yellow

Dimension drawing, see pages 194 to 198



One-piece SPD with high discharge capability and low protection level

MP RK GDT/Ad-Ad-Pg / MP RK GDT/Ad-Ad / MP RK GDT/Ad-Pg

Terminal blocks with integrated surge protection can optimize the used space in a control cabinet and at the same time provide high level protection for terminal equipment and devices.

- Protective circuit for 2 signal lines with common ground (Ad-Ad-Pg)
- Protective circuit for 2 signal lines without reference to ground potential (Ad-Ad)
- Applicable at the boundaries LPZ 0B - 2 and higher
- Test standard: IEC 61643-21 / EN 61643-21
- Mounting on 35 mm DIN rail
- Space required for installation: 6,2 mm
- Earthing via DIN rail or connector

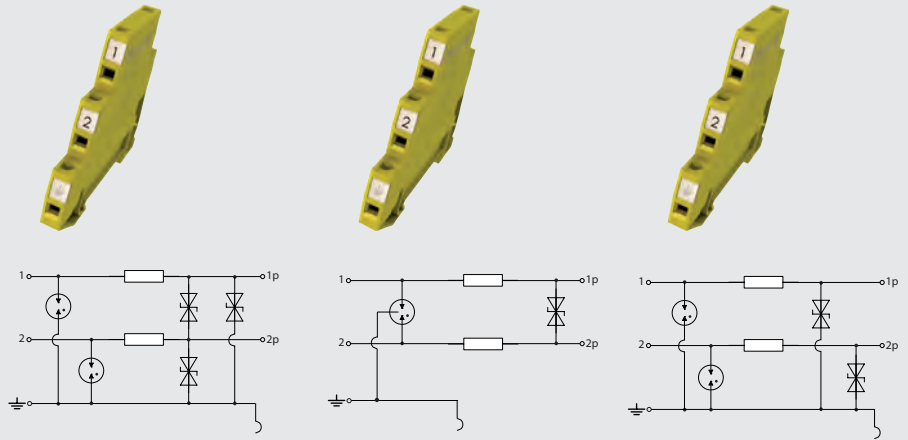

MP RK GDT/Ad-Ad-Pg

MP RK GDT/Ad-Ad

MP RK GDT/Ad-Pg

Basic circuit diagram

Technical Data	MP RK GDT+5V-Ad-Ad-Pg	MP RK GDT+12V-Ad-Ad-Pg	MP RK GDT+24V-Ad-Ad-Pg	MP RK GDT+36V-Ad-Ad-Pg
Article-No.	97 10 18	97 10 19	97 10 20	97 10 21
IEC category/EN type	C2 / C1 / C3	C2 / C1 / C3	C2 / C1 / C3	C2 / C1 / C3
Nominal voltage UN	5 V	12 V	24 V	36 V
Max. continuous operating voltage (DC/AC) Uc	6/4 V	15/11 V	33/23 V	45/32 V
Nominal current IL	0,5 A	0,5 A	0,5 A	0,5 A
C2 nominal discharge current (8/20 μs) total Imax	10 kA	10 kA	10 kA	10 kA
C2 nominal discharge current (8/20 μs) per line In	5 kA	5 kA	5 kA	5 kA
Protection level line-line at In C2 Up	≤ 13 V	≤ 25 V	≤ 59 V	≤ 75 V
Protection level line-earth at In C2 Up	≤ 13 V	≤ 25 V	≤ 59 V	≤ 75 V
Protection level line-line at 1 kV/μs C3 Up	≤ 10 V	≤ 19 V	≤ 45 V	≤ 58 V
Protection level line-earth at 1 kV/μs C3 Up	≤ 10 V	≤ 19 V	≤ 45 V	≤ 58 V
Series resistance per line Rs	2,2 Ω	2,2 Ω	2,2 Ω	2,2 Ω
Max. operating frequency (-3 dB) fG	typ. 1 MHz	typ. 3,0 MHz	typ. 6,0 MHz	typ. 8,0 MHz
Conductor cross section (solid/stranded/AWG)	0.2-4.0/0.2-2.5 mm ² / 24-12	0.2-4.0/0.2-2.5 mm ² / 24-12	0.2-4.0/0.2-2.5 mm ² / 24-12	0.2-4.0/0.2-2.5 mm ² / 24-12
Operating temperature range TU	-40 - +80 °C	-40 - +80 °C	-40 - +80 °C	-40 - +80 °C
Inflammability class according to UL 94	V0	V0	V0	V0
Degree of protection (IEC EN 60529)	IP 20	IP 20	IP 20	IP 20
Enclosure material / colour	PA6 / yellow	PA6 / yellow	PA6 / yellow	PA6 / yellow

Dimension drawing, see pages 194 to 198



SURGE PROTECTION FOR MEASURING SYSTEMS AND AUTOMATIC CONTROL DEVICES

ONE-PIECE SPD FOR MCR APPLICATIONS

Technical Data	MP RK GDT+48V-Ad-Ad-Pg	MP RK GDT+60V-Ad-Ad-Pg	MP RK GDT+170V-Ad-Ad-Pg
Article-No.	97 10 22	97 10 23	97 10 24
IEC category/EN type	C2 / C1 / C3	C2 / C1 / C3	C2 / C1 / C3
Nominal voltage	UN 48 V	60 V	170 V
Max. continuous operating voltage (DC/AC)	Uc 54/38 V	70/49 V	170/120 V
Nominal current	IL 0,5 A	0,5 A	0,5 A
C2 nominal discharge current (8/20 μs) total	I _{max} 10 kA	10 kA	10 kA
C2 nominal discharge current (8/20 μs) per line	I _n 5 kA	5 kA	5 kA
Protection level line-line at I _n C2	U _p ≤ 90 V	≤ 120 V	≤ 320 V
Protection level line-earth at I _n C2	U _p ≤ 90 V	≤ 120 V	≤ 320 V
Protection level line-line at 1 kV/μs C3	U _p ≤ 70 V	≤ 90 V	≤ 250 V
Protection level line-earth at 1 kV/μs C3	U _p ≤ 70 V	≤ 90 V	≤ 250 V
Series resistance per line	R _s 2,2 Ω	2,2 Ω	2,2 Ω
Max. operating frequency (-3 dB)	f _G typ. 10 MHz	typ. 12 MHz	typ. 25 MHz
Conductor cross section (solid/stranded/AWG)	0.2-4.0/0.2-2.5 mm ² / 24-12	0.2-4.0/0.2-2.5 mm ² / 24-12	0.2-4.0/0.2-2.5 mm ² / 24-12
Operating temperature range	TU -40 - +80 °C	-40 - +80 °C	-40 - +80 °C
Inflammability class according to UL 94	V0	V0	V0
Degree of protection (IEC EN 60529)	IP 20	IP 20	IP 20
Enclosure material / colour	PA6 / yellow	PA6 / yellow	PA6 / yellow

Technical Data	MP RK GDT+5V-Ad-Ad	MP RK GDT+12V-Ad-Ad	MP RK GDT+24V-Ad-Ad	MP RK GDT+36V-Ad-Ad
Article-No.	97 10 04	97 10 05	97 10 06	97 10 07
IEC category/EN type	C2 / C1 / C3	C1 / C2 / C3	C2 / C1 / C3	C2 / C1 / C3
Nominal voltage	UN 5 V	12 V	24 V	36 V
Max. continuous operating voltage (DC/AC)	Uc 6/4 V	15/11 V	33/23 V	45/32 V
Nominal current	IL 0,5 A	0,5 A	0,5 A	0,5 A
C2 nominal discharge current (8/20 μs) total	I _{max} 10 kA	10 kA	10 kA	10 kA
C2 nominal discharge current (8/20 μs) per line	I _n 5 kA	5 kA	5 kA	5 kA
Protection level line-line at I _n C2	U _p ≤ 13 V	≤ 25 V	≤ 59 V	≤ 75 V
Protection level line-earth at I _n C2	U _p ≤ 500 V	≤ 500 V	≤ 500 V	≤ 500 V
Protection level line-line at 1 kV/μs C3	U _p ≤ 10 V	≤ 19 V	≤ 45 V	≤ 58 V
Protection level line-earth at 1 kV/μs C3	U _p ≤ 500 V	≤ 500 V	≤ 500 V	≤ 500 V
Series resistance per line	R _s 2,2 Ω	2,2 Ω	2,2 Ω	2,2 Ω
Max. operating frequency (-3 dB)	f _G typ. 1 MHz	typ. 3,0 MHz	typ. 6,0 MHz	typ. 8,0 MHz
Conductor cross section (solid/stranded/AWG)	0.2-4.0/0.2-2.5 mm ² / 24-12	0.2-4.0/0.2-2.5 mm ² / 24-12	0.2-4.0/0.2-2.5 mm ² / 24-12	0.2-4.0/0.2-2.5 mm ² / 24-12
Operating temperature range	TU -40 - +80 °C	-40 - +80 °C	-40 - +80 °C	-40 - +80 °C
Inflammability class according to UL 94	V0	V0	V0	V0
Degree of protection (IEC EN 60529)	IP 20	IP 20	IP 20	IP 20
Enclosure material / colour	PA6 / yellow	PA6 / yellow	PA6 / yellow	PA6 / yellow

Accessories MP terminal block	
Article-No.	MP RK-AB 97 10 02

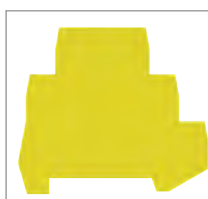

Cover block terminal of MP series

Dimension drawing, see pages 194 to 198

SURGE PROTECTION FOR MEASURING SYSTEMS AND AUTOMATIC CONTROL DEVICES

ONE-PIECE SPD FOR MCR APPLICATIONS



Technical Data	MP RK GDT+48V-Ad-Ad	MP RK GDT+60V-Ad-Ad	MP RK GDT+170V-Ad-Ad
Article-No.	97 10 08	97 10 09	97 10 10
IEC category/EN type	C2 / C1 / C3	C1 / C2 / C3	C1 / C2 / C3
Nominal voltage	UN 48 V	60 V	170 V
Max. continuous operating voltage (DC/AC)	Uc 54/38 V	70/49 V	170/120 V
Nominal current	IL 0,5 A	0,5 A	0,5 A
C2 nominal discharge current (8/20 μs) total	I _{max} 10 kA	10 kA	10 kA
C2 nominal discharge current (8/20 μs) per line	I _n 5 kA	5 kA	5 kA
Protection level line-line at I _n C2	U _p ≤ 90 V	≤ 120 V	≤ 320 V
Protection level line-earth at I _n C2	U _p ≤ 500 V	≤ 500 V	≤ 500 V
Protection level line-line at 1 kV/μs C3	U _p ≤ 70 V	≤ 90 V	≤ 250 V
Protection level line-earth at 1 kV/μs C3	U _p ≤ 500 V	≤ 500 V	≤ 500 V
Series resistance per line	R _s 2,2 Ω	2,2 Ω	2,2 Ω
Max. operating frequency (-3 dB)	f _G typ. 10 MHz	typ. 12 MHz	typ. 25 MHz
Conductor cross section (solid/stranded/AWG)	0.2-4.0/0.2-2.5 mm ² / 24-12	0.2-4.0/0.2-2.5 mm ² / 24-12	0.2-4.0/0.2-2.5 mm ² / 24-12
Operating temperature range	TU -40 - +80 °C	-40 - +80 °C	-40 - +80 °C
Inflammability class according to UL 94	V0	V0	V0
Degree of protection (IEC EN 60529)	IP 20	IP 20	IP 20
Enclosure material / colour	PA6 / yellow	PA6 / yellow	PA6 / yellow

Technical Data	MP RK GDT+5V-Ad-Pg	MP RK GDT+12V-Ad-Pg	MP RK GDT+24V-Ad-Pg	MP RK GDT+36V-Ad-Pg
Article-No.	97 10 11	97 10 12	97 10 13	97 10 14
IEC category/EN type	C1 / C2 / C3	C1 / C2 / C3	C2 / C1 / C3	C1 / C2 / C3
Nominal voltage	UN 5 V	12 V	24 V	36 V
Max. continuous operating voltage (DC/AC)	Uc 6/4 V	15/11 V	33/23 V	45/32 V
Nominal current	IL 0,5 A	0,5 A	0,5 A	0,5 A
C2 nominal discharge current (8/20 μs) total	I _{max} 10 kA	10 kA	10 kA	10 kA
C2 nominal discharge current (8/20 μs) per line	I _n 5 kA	5 kA	5 kA	5 kA
Protection level line-line at I _n C2	U _p ≤ 26 V	≤ 50 V	≤ 118 V	≤ 150 V
Protection level line-earth at I _n C2	U _p ≤ 13 V	≤ 25 V	≤ 59 V	≤ 75 V
Protection level line-line at 1 kV/μs C3	U _p ≤ 20 V	≤ 38 V	≤ 90 V	≤ 116 V
Protection level line-earth at 1 kV/μs C3	U _p ≤ 10 V	≤ 19 V	≤ 45 V	≤ 58 V
Series resistance per line	R _s 2,2 Ω	2,2 Ω	2,2 Ω	2,2 Ω
Max. operating frequency (-3 dB)	f _G typ. 1 MHz	typ. 3,0 MHz	typ. 6,0 MHz	typ. 8,0 MHz
Conductor cross section (solid/stranded/AWG)	0.2-4.0/0.2-2.5 mm ² / 24-12	0.2-4.0/0.2-2.5 mm ² / 24-12	0.2-4.0/0.2-2.5 mm ² / 24-12	0.2-4.0/0.2-2.5 mm ² / 24-12
Operating temperature range	TU -40 - +80 °C	-40 - +80 °C	-40 - +80 °C	-40 - +80 °C
Inflammability class according to UL 94	V0	V0	V0	V0
Degree of protection (IEC EN 60529)	IP 20	IP 20	IP 20	IP 20
Enclosure material / colour	PA6 / yellow	PA6 / yellow	PA6 / yellow	PA6 / yellow

Dimension drawing, see pages 194 to 198



SURGE PROTECTION FOR MEASURING SYSTEMS AND AUTOMATIC CONTROL DEVICES

ONE-PIECE SPD FOR MCR APPLICATIONS

Technical Data	MP RK GDT+48V-Ad-Pg	MP RK GDT+60V-Ad-Pg	MP RK GDT+170V-Ad-Pg
Article-No.	97 10 15	97 10 16	97 10 17
IEC category/EN type	C1 / C2 / C3	C1 / C2 / C3	C1 / C2 / C3
Nominal voltage	UN 48 V	60 V	170 V
Max. continuous operating voltage (DC/AC)	Uc 54/38 V	70/49 V	170/120 V
Nominal current	IL 0,5 A	0,5 A	0,5 A
C2 nominal discharge current (8/20 μs) total	Imax 10 kA	10 kA	10 kA
C2 nominal discharge current (8/20 μs) per line	In 5 kA	5 kA	5 kA
Protection level line-line at In C2	Up ≤ 180 V	≤ 240 V	≤ 600 V
Protection level line-earth at In C2	Up ≤ 90 V	≤ 120 V	≤ 320 V
Protection level line-line at 1 kV/μs C3	Up ≤ 140 V	≤ 180 V	≤ 500 V
Protection level line-earth at 1 kV/μs C3	Up ≤ 70 V	≤ 90 V	≤ 250 V
Series resistance per line	Rs 2,2 Ω	2,2 Ω	2,2 Ω
Max. operating frequency (-3 dB)	fG typ. 10 MHz	typ. 12 MHz	typ. 25 MHz
Conductor cross section (solid/stranded/AWG)	0.2-4.0/0.2-2.5 mm ² / 24-12	0.2-4.0/0.2-2.5 mm ² / 24-12	0.2-4.0/0.2-2.5 mm ² / 24-12
Operating temperature range	TU -40 - +80 °C	-40 - +80 °C	-40 - +80 °C
Inflammability class according to UL 94	V0	V0	V0
Degree of protection (IEC EN 60529)	IP 20	IP 20	IP 20
Enclosure material / colour	PA6 / yellow	PA6 / yellow	PA6 / yellow

Accessories MP terminal block	
Article-No.	MP RK-AB 97 10 02

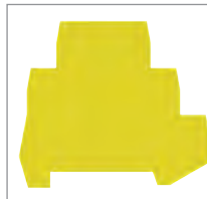

Cover block terminal of MP series

Dimension drawing, see pages 194 to 198



One-piece SPD with low protection level for MCR applications

MP RK/Ad-Ad / MP RK/Ad-Pg / MP RK/Ad-Ad-Pg

Terminal blocks with integrated surge protection can optimize the used space in a control cabinet and at the same time provide high level protection for terminal equipment and devices.

- Protective circuit for 2 signal lines without reference to ground potential (line-line)
- Protective circuit for 2 signal lines with common ground (line-earth)
- Applicable at the boundaries LPZ 1 - 2 and higher
- Test standard: IEC 61643-21 / EN 61643-21
- Mounting on 35 mm DIN rail
- Space required for installation: 6,2 mm
- Earthing via DIN rail or connector

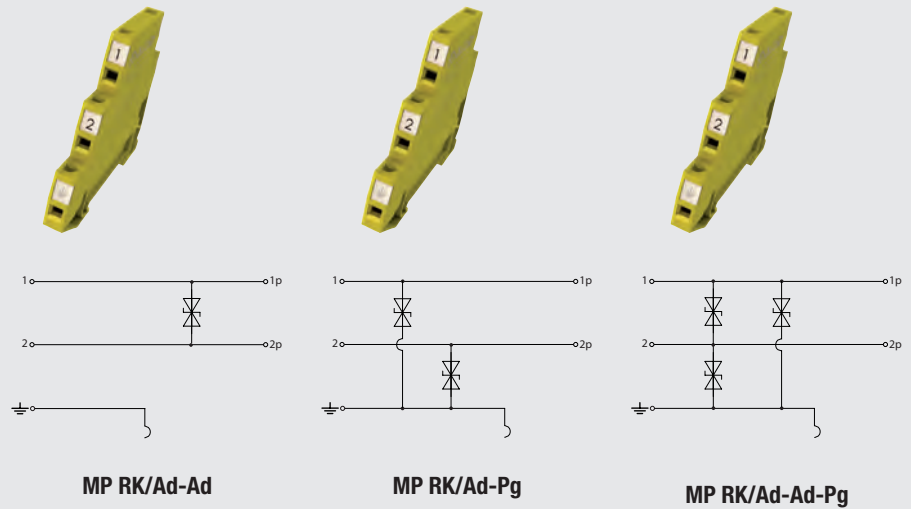

Basic circuit diagram

Technical Data	MP RK 5V-Ad-Ad	MP RK 12V-Ad-Ad	MP RK 24V-Ad-Ad	MP RK 36V-Ad-Ad
Article-No.	97 10 25	97 10 26	97 10 27	97 10 28
IEC category/EN type	C1 / C3	C1 / C3	C1 / C3	C1 / C3
Nominal voltage	UN 5 V	12 V	24 V	36 V
Max. continuous operating voltage (DC/AC)	Uc 6/4 V	15/11 V	33/23 V	45/32 V
Nominal current	IL 2,0 A	2,0 A	2,0 A	2,0 A
C1 Nominal discharge current (8/20) total	In 0,8 kA	0,8 kA	0,6 kA	0,4 kA
C1 Nominal discharge current (8/20) per wire	In 0,4 kA	0,4 kA	0,3 kA	0,2 kA
Protection level line-line at In C1	Up ≤ 13 V	≤ 25 V	≤ 48 V	≤ 70 V
Protection level line-line at 1 kV/μs C3	Up ≤ 10 V	≤ 19 V	≤ 45 V	≤ 58 V
Series resistance per line	Rs 0 Ω	0 Ω	0 Ω	0 Ω
Max. operating frequency (-3 dB)	fG typ. 1,0 MHz	typ. 3,0 MHz	typ. 6,0 MHz	typ. 8,0 MHz
Conductor cross section (solid/stranded/AWG)	0.2-4.0/0.2-2.5 mm ² / 24-12	0.2-4.0/0.2-2.5 mm ² / 24-12	0.2-4.0/0.2-2.5 mm ² / 24-12	0.2-4.0/0.2-2.5 mm ² / 24-12
Operating temperature range	TU -40 - +80 °C	-40 - +80 °C	-40 - +80 °C	-40 - +80 °C
Inflammability class according to UL 94	V0	V0	V0	V0
Degree of protection (IEC EN 60529)	IP 20	IP 20	IP 20	IP 20
Enclosure material / colour	PA6 / yellow	PA6 / yellow	PA6 / yellow	PA6 / yellow
Installation width	6,2 mm	6,2 mm	6,2 mm	6,2 mm
Mounting on	35 mm DIN rail (EN 60715)	35 mm DIN rail (EN 60715)	35 mm DIN rail (EN 60715)	35 mm DIN rail (EN 60715)

Dimension drawing, see pages 194 to 198



SURGE PROTECTION FOR MEASURING SYSTEMS AND AUTOMATIC CONTROL DEVICES

ONE-PIECE SPD FOR MCR APPLICATIONS

Technical Data	MP RK 48V-Ad-Ad	MP RK 60V-Ad-Ad	MP RK 170V-Ad-Ad
Article-No.	97 10 29	97 10 30	97 10 31
IEC category/EN type	C1 / C3	C1 / C3	C1 / C3
Nominal voltage	UN 48 V	60 V	170 V
Max. continuous operating voltage (DC/AC)	Uc 54/38 V	70/49 V	170/120 V
Nominal current	IL 2,0 A	2,0 A	2,0 A
C1 Nominal discharge current (8/20) total	In 0,3 kA	0,24 kA	0,2 kA
C1 Nominal discharge current (8/20) per wire	In 0,15 kA	0,12 kA	0,1 kA
Protection level line-line at In C1	Up ≤ 90 V	≤ 110 V	≤ 300 V
Protection level line-line at 1 kV/μs C3	Up ≤ 70 V	≤ 90 V	≤ 250 V
Series resistance per line	Rs 0 Ω	0 Ω	0 Ω
Max. operating frequency (-3 dB)	fG typ. 10 MHz	typ. 12 MHz	typ. 25 MHz
Conductor cross section (solid/stranded/AWG)	0.2-4.0/0.2-2.5 mm ² / 24-12	0.2-4.0/0.2-2.5 mm ² / 24-12	0.2-4.0/0.2-2.5 mm ² / 24-12
Operating temperature range	TU -40 - +80 °C	-40 - +80 °C	-40 - +80 °C
Inflammability class according to UL 94	V0	V0	V0
Degree of protection (IEC EN 60529)	IP 20	IP 20	IP 20
Enclosure material / colour	PA6 / yellow	PA6 / yellow	PA6 / yellow
Installation width	6,2 mm	6,2 mm	6,2 mm
Mounting on	35 mm DIN rail (EN 60715)	35 mm DIN rail (EN 60715)	35 mm DIN rail (EN 60715)

Technical Data	MP RK 5V-Ad-Pg	MP RK 12V-Ad-Pg	MP RK 24V-Ad-Pg	MP RK 36V-Ad-Pg
Article-No.	97 10 32	97 10 33	97 10 34	97 10 35
IEC category/EN type	C1 / C3	C1 / C3	C1 / C3	C1 / C3
Nominal voltage	UN 5 V	12 V	24 V	36 V
Max. continuous operating voltage (DC/AC)	Uc 6/4 V	15/11 V	33/23 V	45/32 V
Nominal current	IL 2,0 A	2,0 A	2,0 A	2,0 A
C1 Nominal discharge current (8/20) total	In 0,8 kA	0,8 kA	0,6 kA	0,4 kA
C1 Nominal discharge current (8/20) per wire	In 0,4 kA	0,4 kA	0,3 kA	0,2 kA
Protection level line-line at In C1	Up ≤ 26 V	≤ 50 V	≤ 96 V	≤ 140 V
Protection level line-earth at In C1	Up ≤ 13 V	≤ 25 V	≤ 48 V	≤ 70 V
Protection level line-line at 1 kV/μs C3	Up ≤ 20 V	≤ 38 V	≤ 90 V	≤ 116 V
Protection level line-earth at 1 kV/μs C3	Up ≤ 10 V	≤ 19 V	≤ 45 V	≤ 58 V
Series resistance per line	Rs 0 Ω	0 Ω	0 Ω	0 Ω
Max. operating frequency (-3 dB)	fG typ. 1,0 MHz	typ. 3,0 MHz	typ. 6,0 MHz	typ. 8,0 MHz
Conductor cross section (solid/stranded/AWG)	0.2-4.0/0.2-2.5 mm ² / 24-12	0.2-4.0/0.2-2.5 mm ² / 24-12	0.2-4.0/0.2-2.5 mm ² / 24-12	0.2-4.0/0.2-2.5 mm ² / 24-12
Operating temperature range	TU -40 - +80 °C	-40 - +80 °C	-40 - +80 °C	-40 - +80 °C
Inflammability class according to UL 94	V0	V0	V0	V0
Degree of protection (IEC EN 60529)	IP 20	IP 20	IP 20	IP 20
Enclosure material / colour	PA6 / yellow	PA6 / yellow	PA6 / yellow	PA6 / yellow

Accessories MP terminal block	
Article-No.	MP RK-AB 97 10 02

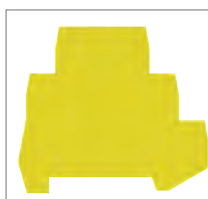

Cover block terminal of MP series

Dimension drawing, see pages 194 to 198

SURGE PROTECTION FOR MEASURING SYSTEMS AND AUTOMATIC CONTROL DEVICES

ONE-PIECE SPD FOR MCR APPLICATIONS



Technical Data	MP RK 48V-Ad-Pg	MP RK 60V-Ad-Pg	MP RK 170V-Ad-Pg
Article-No.	97 10 36	97 10 37	97 10 38
IEC category/EN type	C1 / C3	C1 / C3	C1 / C3
Nominal voltage	UN 48 V	60 V	170 V
Max. continuous operating voltage (DC/AC)	Uc 54/38 V	70/49 V	170/120 V
Nominal current	IL 2,0 A	2,0 A	2,0 A
C1 Nominal discharge current (8/20) total	In 0,3 kA	0,24 kA	0,2 kA
C1 Nominal discharge current (8/20) per wire	In 0,15 kA	0,12 kA	0,1 kA
Protection level line-line at In C1	Up ≤ 180 V	≤ 220 V	≤ 600 V
Protection level line-earth at In C1	Up ≤ 90 V	≤ 110 V	≤ 300 V
Protection level line-line at 1 kV/μs C3	Up ≤ 140 V	≤ 180 V	≤ 500 V
Protection level line-earth at 1 kV/μs C3	Up ≤ 70 V	≤ 90 V	≤ 250 V
Series resistance per line	Rs 0 Ω	0 Ω	0 Ω
Max. operating frequency (-3 dB)	fG typ. 10 MHz	typ. 12 MHz	typ. 25 MHz
Conductor cross section (solid/stranded/AWG)	0.2-4.0/0.2-2.5 mm ² / 24-12	0.2-4.0/0.2-2.5 mm ² / 24-12	0.2-4.0/0.2-2.5 mm ² / 24-12
Operating temperature range	TU -40 - +80 °C	-40 - +80 °C	-40 - +80 °C
Inflammability class according to UL 94	V0	V0	V0
Degree of protection (IEC EN 60529)	IP 20	IP 20	IP 20
Enclosure material / colour	PA6 / yellow	PA6 / yellow	PA6 / yellow

Technical Data	MP RK 5V-Ad-Ad-Pg	MP RK 12V-Ad-Ad-Pg	MP RK 24V-Ad-Ad-Pg	MP RK 36V-Ad-Ad-Pg
Article-No.	97 10 39	97 10 40	97 10 41	97 10 42
IEC category/EN type	C1 / C3	C1 / C3	C1 / C3	C1 / C3
Nominal voltage	UN 5 V	12 V	24 V	36 V
Max. continuous operating voltage (DC/AC)	Uc 6/4 V	15/11 V	33/23 V	45/32 V
Nominal current	IL 2,0 A	2,0 A	2,0 A	2,0 A
C1 Nominal discharge current (8/20) total	In 0,8 kA	0,8 kA	0,6 kA	0,4 kA
C1 Nominal discharge current (8/20) per wire	In 0,4 kA	0,4 kA	0,3 kA	0,2 kA
Protection level line-line at In C1	Up ≤ 13 V	≤ 25 V	≤ 48 V	≤ 70 V
Protection level line-earth at In C1	Up ≤ 13 V	≤ 25 V	≤ 48 V	≤ 70 V
Protection level line-line at 1 kV/μs C3	Up ≤ 10 V	≤ 19 V	≤ 45 V	≤ 58 V
Protection level line-earth at 1 kV/μs C3	Up ≤ 10 V	≤ 19 V	≤ 45 V	≤ 58 V
Series resistance per line	Rs 0 Ω	0 Ω	0 Ω	0 Ω
Max. operating frequency (-3 dB)	fG typ. 1,0 MHz	typ. 3,0 MHz	typ. 6,0 MHz	typ. 8,0 MHz
Conductor cross section (solid/stranded/AWG)	0.2-4.0/0.2-2.5 mm ² / 24-12	0.2-4.0/0.2-2.5 mm ² / 24-12	0.2-4.0/0.2-2.5 mm ² / 24-12	0.2-4.0/0.2-2.5 mm ² / 24-12
Operating temperature range	TU -40 - +80 °C	-40 - +80 °C	-40 - +80 °C	-40 - +80 °C
Inflammability class according to UL 94	V0	V0	V0	V0
Degree of protection (IEC EN 60529)	IP 20	IP 20	IP 20	IP 20
Enclosure material / colour	PA6 / yellow	PA6 / yellow	PA6 / yellow	PA6 / yellow

Dimension drawing, see pages 194 to 198



SURGE PROTECTION FOR MEASURING SYSTEMS AND AUTOMATIC CONTROL DEVICES

ONE-PIECE SPD FOR MCR APPLICATIONS

Technical Data	MP RK 48V-Ad-Ad-Pg	MP RK 60V-Ad-Ad-Pg	MP RK 170V-Ad-Ad-Pg
Article-No.	97 10 43	97 10 44	97 10 45
IEC category/EN type	C1 / C3	C1 / C3	C1 / C3
Nominal voltage	UN 48 V	60 V	170 V
Max. continuous operating voltage (DC/AC)	Uc 54/38 V	70/49 V	170/120 V
Nominal current	IL 2,0 A	2,0 A	2,0 A
C1 Nominal discharge current (8/20) total	In 0,3 kA	0,24 kA	0,2 kA
C1 Nominal discharge current (8/20) per wire	In 0,15 kA	0,12 kA	0,1 kA
Protection level line-line at In C1	Up ≤ 90 V	≤ 110 V	≤ 300 V
Protection level line-earth at In C1	Up ≤ 90 V	≤ 110 V	≤ 300 V
Protection level line-line at 1 kV/μs C3	Up ≤ 70 V	≤ 90 V	≤ 250 V
Protection level line-earth at 1 kV/μs C3	Up ≤ 70 V	≤ 90 V	≤ 250 V
Series resistance per line	Rs 0 Ω	0 Ω	0 Ω
Max. operating frequency (-3 dB)	fG typ. 10 MHz	typ. 12 MHz	typ. 25 MHz
Conductor cross section (solid/stranded/AWG)	0.2-4.0/0.2-2.5 mm ² / 24-12	0.2-4.0/0.2-2.5 mm ² / 24-12	0.2-4.0/0.2-2.5 mm ² / 24-12
Operating temperature range	TU -40 - +80 °C	-40 - +80 °C	-40 - +80 °C
Inflammability class according to UL 94	V0	V0	V0
Degree of protection (IEC EN 60529)	IP 20	IP 20	IP 20
Enclosure material / colour	PA6 / yellow	PA6 / yellow	PA6 / yellow

Accessories MP terminal block	
	MP RK-AB
Article-No.	97 10 02

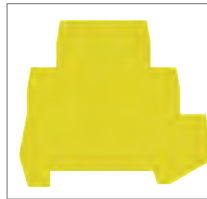

Cover block terminal of MP series

Dimension drawing, see pages 194 to 198



MSR-M20

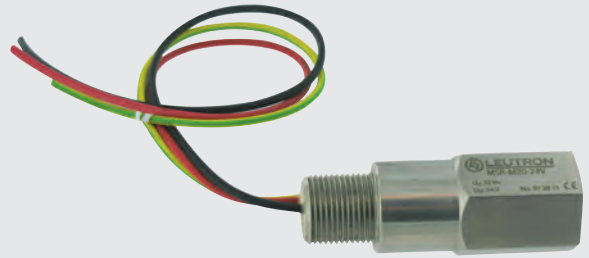

The protection device is a unique unit providing a level of protection for field-mounted transmitters that is far in excess of the optional transient protection facilities available from the transmitter manufacturers - without involving any additional wiring, conduit modifications or other expensive extras.

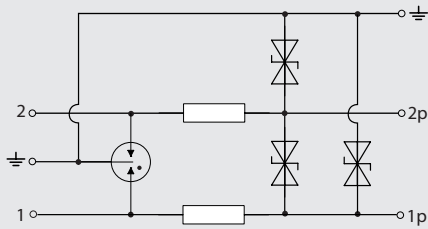

Basic circuit diagram



- Applicable at the LPZ transition point OB-2 and higher
- Easy mounting directly
- Highest protection level with inline installation
- Low impedance series connection avoids signal degradation of the loop
- Intrinsically safe and flameproof
- Test standard: IEC 61643-21 / EN 61643-21
- Earthing via metal housing

		
Technical Data	MSR-M20-24V	MSR-M20-24V-Fine
Article-No.	97 20 11	97 20 12
IEC category/EN type	D1 / C2 / C1 / C3	D1 / C2 / C1 / C3
Nominal voltage	UN 24 V	24 V
Max. continuous operating voltage DC	Uc 32 V=	32 V=
Nominal current	IL 1,5 A	1,5 A
D1 lightning impulse current (10/350) per wire	Iimp 1,0 kA	1,0 kA
C2 nominal discharge current (8/20 μs) total	I _{max} 10 kA	10 kA
Protection level line-line at In C2	Up -	≤ 65 V
Protection level line-earth at In C2	Up -	≤ 65 V
Series resistance per line	Rs 0,5 Ω	0,5 Ω
Capacitance wire-wire	C ≤ 400 pF	≤ 400 pF
Capacitance line-earth	C ≤ 20 pF	≤ 20 pF
Max. operating frequency Ad-Ad	fG 14 MHz	14 MHz
Operating temperature range	TU -40 - +80 °C	-40 - +80 °C
Terminal input/output	screw/line 1,5 mm ²	screw/line 1,5 mm ²
Conductor cross section single wire	0,08-2,5 mm ²	0,08-2,5 mm ²
Conductor cross section fine stranded	0,08-1,5 mm ²	0,08-1,5 mm ²
Length of connecting line	200 mm	200 mm

Dimension drawing, see pages 194 to 198

COMPREHENSIVE PROTECTION OF ALL COMMUNICATION NETWORKS

For an unobstructed data transmission it is vital to protect the communication networks against surge voltages. Leutron's products reliably protect server rooms, workstations, IT and telephone installations against surge voltages – protection concepts for large-scale as well as for small installations are offered.

Leutron offers an optimum protection for the communication networks of its clients.

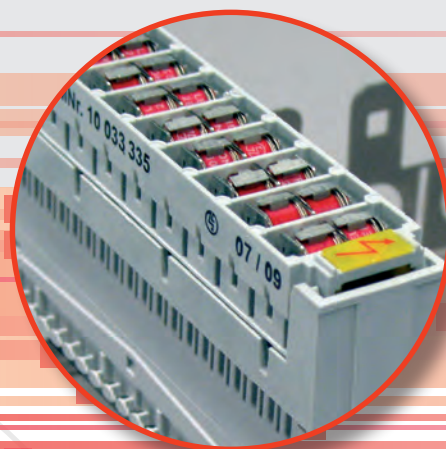
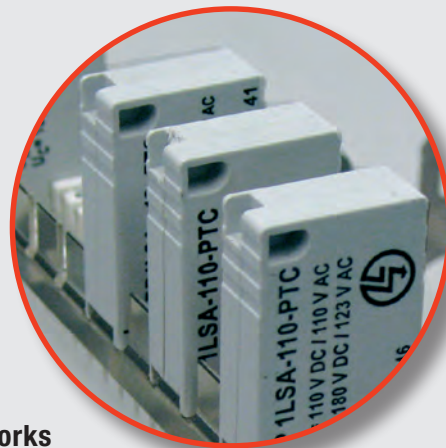

ENHANCED AVAILABILITY IN COMPLEX COMMUNICATION ENVIRONMENTS:

- All-purpose protection devices for all communication networks due to different interfaces and various bandwidths (up to 10 G Ethernet)
- The overvoltage is limited to non-hazardous values with protection levels adapted to the protection-needing equipment
- Plug-and-play units for IT installations improve the operational availability



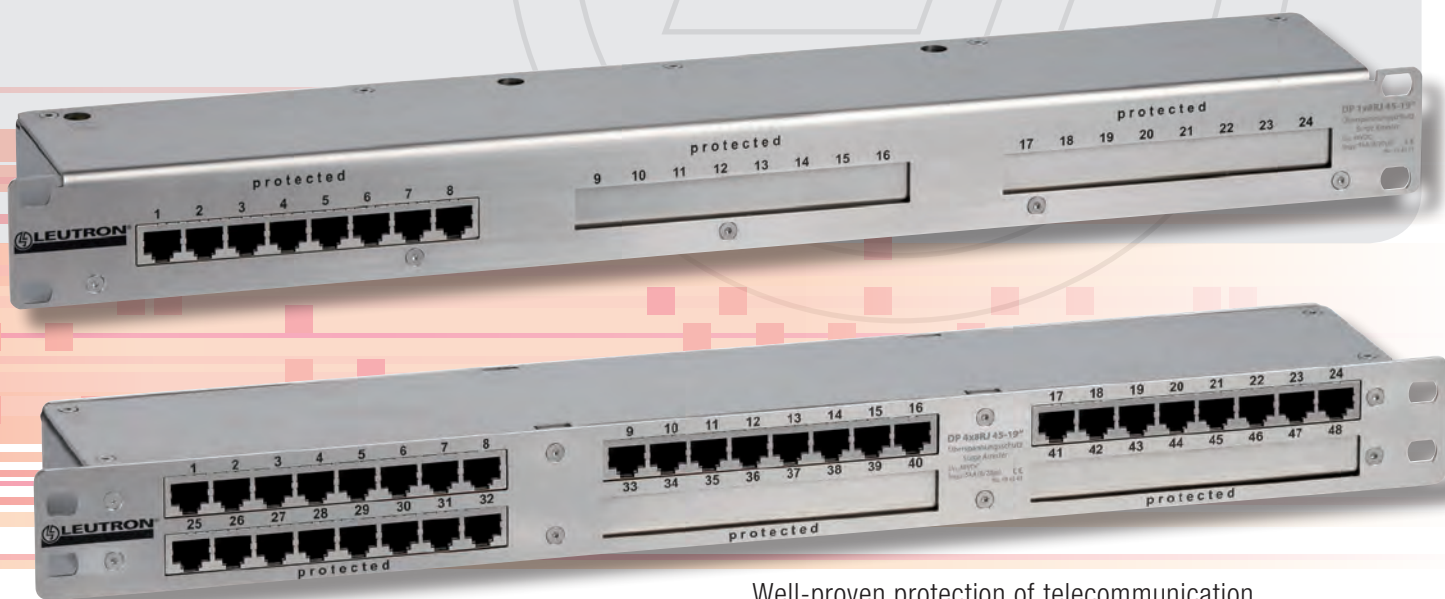

Well-proven protection of telecommunication installations – scalable in size and layout

SURGE PROTECTION FOR INFORMATION TECHNOLOGY AND TELECOMMUNICATION INSTALLATIONS

PROTECTION OF DATA NETWORKS, E.G. ETHERNET AND LAN

RJ45 socket for different interfaces

Suitable for PoE (Power over Ethernet)

Mounting on rail

Protection for LAN up to Cat. 6 (Gbit Ethernet)

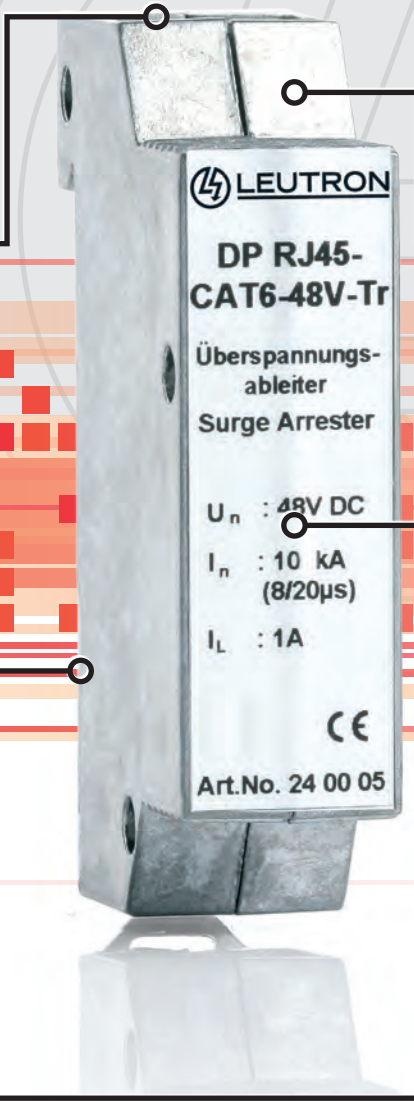

LEUTRON

DP RJ45-CAT6-48V-Tr

Überspannungsableiter
Surge Arrester

U_n : 48V DC
 I_n : 10 kA (8/20µs)
 I_L : 1A

CE

Art.No. 24 00 05

Art.No. 24 00 05

LE

CE

U_n : 48V

(8/20µs)

I_n : 10kA

I_L : 1A



SSCT (LSA) MOUNTING TECHNOLOGY

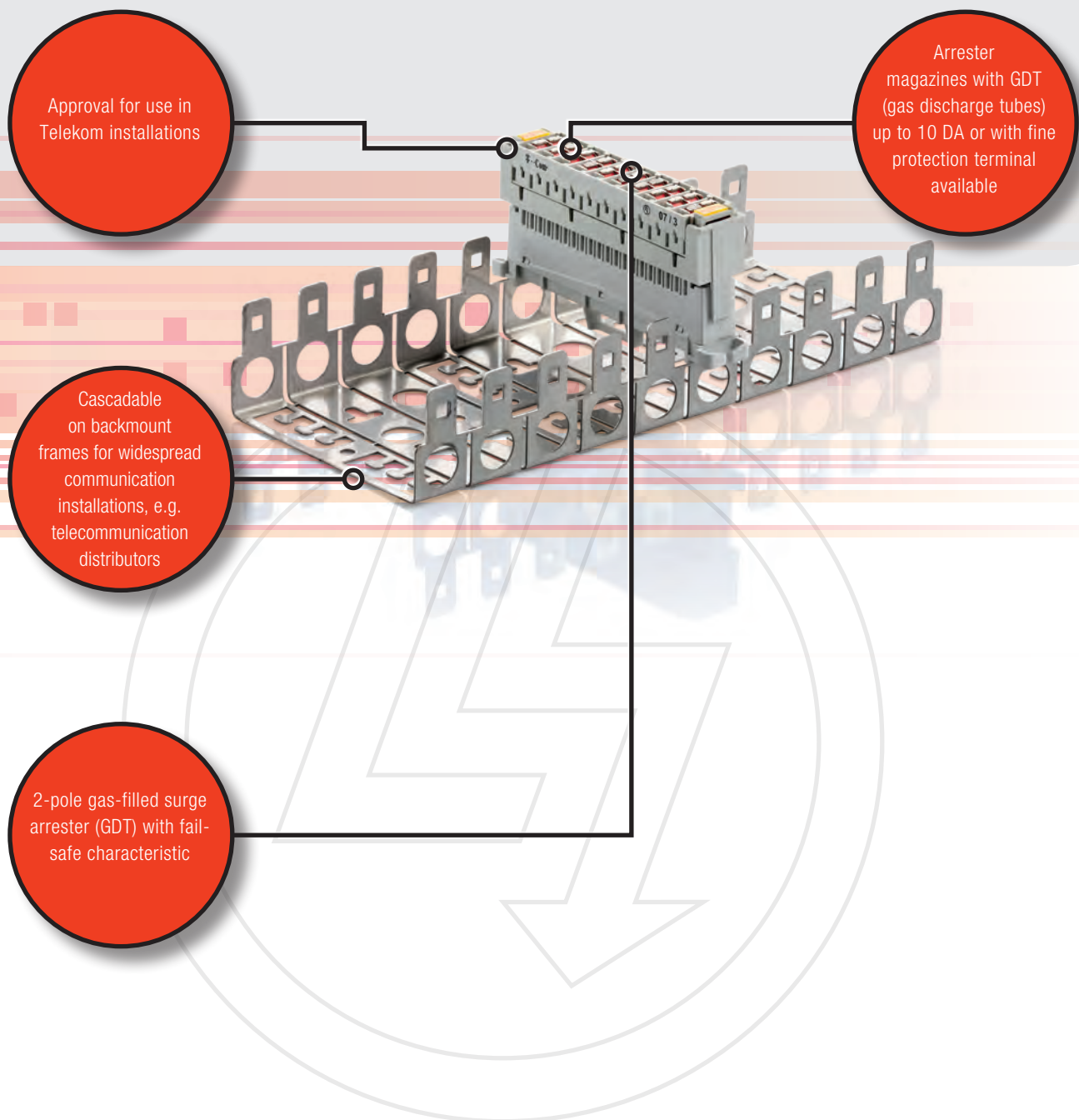



DataPro RJ45-CAT6

Compact surge protective module for the protection of data networks, and network devices such as hubs, switches, server and desktop computer. The adaptor plug style provides an easy application in cable ducts or directly at the terminal equipment.

- Suitable for Cat. 6 / class E applications (up to Gbit Ethernet)
- Applicable at the boundaries LPZ 0B - 2 and higher
- Test standard: IEC 61643-21 / EN 61643-21
- All 8 signal lines (4 pair of wires) are protected simultaneously.
- RJ45 SPD for PoE (Power over Ethernet)
- Mounting on 35 mm DIN rail

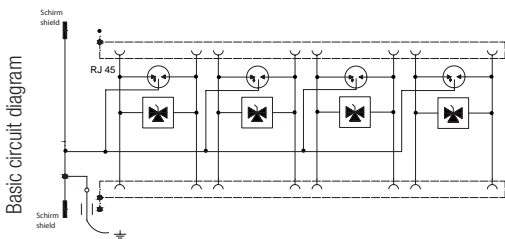

Technical Data	DP RJ45-CAT6-48V-Tr
Article-No.	24 00 05
IEC category/EN type	C2 / C1 / C3
Nominal voltage DC	UN 48 V=
Max. continuous operating voltage DC	Uc 48 V
Operating current	IL 1.000 mA
C2 nominal discharge current line-line	In 0,15 kA
C2 nominal discharge current (8/20 μs) total	Imax 10 kA
Protection level at In (line-line)	Up 150 V
Protection level at In (line-earth)	Up 550 V
Max. frequency	fG 250 MHz
Response time	tA 1 ns
Terminal input/output	RJ 45, shielded
Degree of protection (IEC EN 60529)	IP 20
Housing material	Metall

DataPro-RJ45-48V-Tr

Compact surge protective module for the protection of data networks, and network devices such as hubs, switches, server and desktop computer. The adaptor plug style provides an easy application in cable ducts or directly at the terminal equipment.

- Suitable for Cat. 5 / class E applications (up to Gbit Ethernet)
- Applicable at the boundaries LPZ 1 - 2 and higher
- Test standard: IEC 61643-21 / EN 61643-21
- All 8 signal lines (4 pair of wires) are protected simultaneously.
- RJ45 SPD for PoE (Power over Ethernet)
- Mounting on 35 mm DIN rail

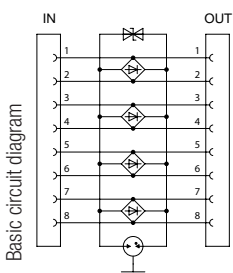

Technical Data	DP RJ45-48V-Tr
Article-No.	23 90 00
IEC category/EN type	C2 / C1 / C3
Nominal voltage DC	UN 48 V=
Nominal voltage DC	Uc 57 V
Protection level at In (8/20)	Up ≤ 600 V
Protection level at 1 kV/μs	Up ≤ 550 V
Max. frequency	fG 100 MHz
Terminal input/output	RJ 45, shielded
Degree of protection (IEC EN 60529)	IP 20
Operating temperature range	-40 - +80°C

Dimension drawing, see pages 194 to 198



DataPro-1xRJ45-PoE-Alu

Compact surge protective module for the protection of data networks, and network devices such as hubs, switches, server and desktop computer. The adaptor plug style provides an easy application in cable ducts or directly at the terminal equipment.

- Suitable for Cat. 5 / class E applications (up to Gbit Ethernet)
- Applicable at the boundaries LPZ 0B - 2 and higher
- Test standard: IEC 61643-21 / EN 61643-21
- Compatible to 10Base T / 100Base T
- RJ45 SPD for PoE (Power over Ethernet)
- All 8 signal lines (4 pair of wires) are protected simultaneously.

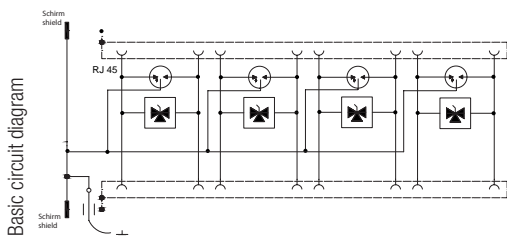

Technical Data	DP 1xRJ45-PoE-Alu
Article-No.	24 00 21
IEC category/EN type	C2 / C1 / C3
Nominal voltage DC	UN 48 V=
Max. continuous operating voltage DC	Uc 60 V
Operating current	IL 650 mA
Nominal discharge current (8/20 μs) line-line	In 0,5 kA
Nominal discharge current (8/20) line-earth	In 2,0 kA
Protection level line-line at 1 kV/μs C3	Up ≤ 180 V
Protection level line-Pg at 1 kV/μs C3	Up ≤ 600 V
Max. frequency	fG ≤ 100 MHz
Terminal input/output	RJ 45, shielded
Degree of protection (IEC EN 60529)	IP 20
Housing material	Metall

DataPro RJ45 (f/f)

Compact surge protective module for the protection of data networks, and network devices such as hubs, switches, server and desktop computer. The adaptor plug style provides an easy application in cable ducts or directly at the terminal equipment.

- Suitable for Cat. 5 / class E applications (up to Gbit Ethernet)
- Applicable at the boundaries LPZ 0B - 2 and higher
- Test standard: IEC 61643-21 / EN 61643-21
- Compatible to 10Base T / 100Base T
- All 8 signal lines (4 pair of wires) are protected simultaneously.

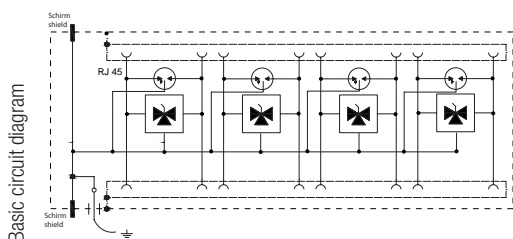

Technical Data	DP RJ45 f/f
Article-No.	24 00 11
IEC category/EN type	C2 / C1 / C3
Nominal voltage DC	UN 6 V=
Max. continuous operating voltage DC	Uc 8 V=
C2 Nominal discharge current (8/20)	In 2,5 kA
Protection level at In (8/20)	Up 35 V
Max. frequency	fG 100 MHz
Operating temperature range	TU -40 - +80 °C
Terminal input/output	RJ 45, shielded
Degree of protection (IEC EN 60529)	IP 20
Housing material	Metall

Dimension drawing, see pages 194 to 198



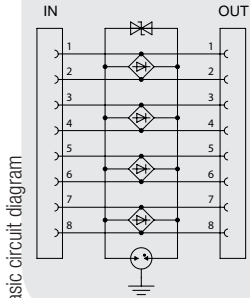

DataPro x8RJ45-19"

Compact surge protective module in 19" housing with only 1 HE (45 mm) for the protection of data networks and network devices such as hubs, switches, server and desktop computer. Easy installation and wiring in all 19" distribution and server racks possible.





Basic circuit diagram

- Applicable at the boundaries LPZ 1 - 2 and higher
- Fully shielded 19" housing can be equipped with up to 48 RJ45 protection ports.
- Suitable for Cat. 5 / class D applications (up to Gbit Ethernet)
- Compatible to 10Base T / 100Base T
- Test standard: IEC 61643-21 / EN 61643-21
- Additional modules for the protection of up to 48 ports can be installed optionally
- All 8 signal lines (4 pair of wires) are protected simultaneously.

				
Technical Data	DP 1x8RJ45-19"	DP 2x8RJ45-19"	DP 3x8RJ45-19"	DP 4x8RJ45-19"
Article-No.	19 40 13	19 40 23	19 40 33	19 40 43
IEC category/EN type	C2 / C1 / C3	C2 / C1 / C3	C2 / C1 / C3	C2 / C1 / C3
Nominal voltage DC	UN 6 V=	6 V=	6 V=	6 V=
Max. continuous operating voltage DC	Uc 8,1 V=	8,1 V=	8,1 V=	8,1 V
Nominal current per line	IL 100 mA	100 mA	100 mA	100 mA
C1 nominal discharge current (8/20µs) per line	In 200 A	200 A	200 A	200 A
C2 Total discharge current (8/20) line-earth (PE)	Imax 2,5 kA	2,5 kA	2,5 kA	2,5 kA
C1 protection level line-line at In	Up ≤ 45 V	≤ 45 V	≤ 45 V	≤ 45 V
C1 protection level line-PE at In	Up ≤ 350 V	≤ 350 V	≤ 350 V	≤ 350 V
C3 protection level line-line at 1kV/µs	Up ≤ 40 V	≤ 40 V	≤ 40 V	≤ 40 V
C3 protection level line-PE at 1kV/µs	Up ≤ 350 V	≤ 350 V	≤ 350 V	≤ 350 V
Response time Line-Line/Line-shield	tA < 1 ns	< 1 ns	< 1 ns	< 1 ns
Response time Line-PE / PE-shield	tA < 100 ns	< 100 ns	< 100 ns	< 100 ns
Max. frequency	fG 100 MHz	100 MHz	100 MHz	100 MHz
Operating temperature range	TU -40 - +80 °C	-40 - +80 °C	-40 - +80 °C	-40 - +80 °C
Terminal input/output	8 x RJ 45, shielded	16 x RJ 45, shielded	24 x RJ 45, shielded	32 x RJ 45, shielded
Degree of protection (IEC EN 60529)	IP 20	IP 20	IP 20	IP 20
Housing material	stainless steel	stainless steel	stainless steel	stainless steel

Dimension drawing, see pages 194 to 198



		
Technical Data	DP 5x8RJ45-19"	DP 6x8RJ45-19"
Article-No.	19 40 53	19 40 63
IEC category/EN type	C2 / C1 / C3	C2 / C1 / C3
Nominal voltage DC	UN 6 V=	6 V=
Max. permissible rated direct voltage	Uc 8,1 V	8,1 V
Nominal current per line	IL 100 mA	100 mA
C1 nominal discharge current (8/20µs) per line	In 200 A	200 A
C2 Total discharge current (8/20) line-earth (PE)	Imax 2,5 kA	2,5 kA
C1 protection level line-line at In	Up ≤ 45 V	≤ 45 V
C1 protection level line-PE at In	Up ≤ 350 V	≤ 350 V
C3 protection level line-line at 1kV/µs	Up ≤ 40 V	≤ 40 V
C3 protection level line-PE at 1kV/µs	Up ≤ 350 V	≤ 350 V
Response time Line-Line/Line-shield	tA < 1 ns	< 1 ns
Response time Line-PE / PE-shield	tA < 100 ns	< 100 ns
Max. frequency	fG 100 MHz	100 MHz
Operating temperature range	TU -40 - +80 °C	-40 - +80 °C
Terminal input/output	40 x RJ 45, shielded	48 x RJ 45, shielded
Degree of protection (IEC EN 60529)	IP 20	IP 20
Housing material	stainless steel	stainless steel



DataPro-8xRJ45-6V-WG

Compact surge protective module in a wall housing for the protection of data networks and network devices such as hubs, switches, server and desktop computer.

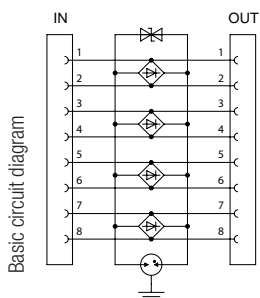
- Applicable at the boundaries LPZ 1 - 2 and higher
- RJ45 wall housing for eight ports
- Suitable for Cat. 5 / class D applications (up to Gbit Ethernet)
- Compatible to 10Base T / 100Base T
- Test standard: IEC 61643-21 / EN 61643-21
- All 8 signal lines (4 pair of wires) are protected simultaneously.



Dimension drawing, see pages 194 to 198

		
Technical Data	DP 8xRJ45-6V-WG	DP-8xRJ45-6x6V/2x48V-WG
Article-No.	19 40 50	19 40 51
IEC category/EN type	C2 / C1 / C3	C2 / C1 / C3
Nominal voltage DC	UN 6 V=	6 x 6 / 2 x 48 V=
Max. continuous operating voltage DC	Uc 8,1 V=	8,1 V=
Nominal current per line	IL 100 mA	100 mA
C1 nominal discharge current (8/20µs) per line	In 200 A	200 A
C2 Total discharge current (8/20) line-PE	Imax 2,5 kA	2,5 kA
C1 protection level line-line at In	Up ≤ 45 V	≤ 76 V
C1 protection level line-PE at In	Up ≤ 350 V	≤ 243 V
C3 protection level line-line at 1kV/µs	Up ≤ 40 V	≤ 146 V
C3 protection level line-PE at 1kV/µs	Up ≤ 350 V	≤ 243 V
Response time Line-Line/Line-shield	tA ≤ 1 ns	≤ 1 ns
Response time Line-PE / PE-shield	tA < 100 ns	< 100 ns
Max. frequency	fG 100 MHz	100 MHz
Operating temperature range	TU -40 - +80 °C	-40 - +80 °C
Terminal input/output	8 x RJ 45, shielded	8 x RJ 45, shielded
Degree of protection (IEC EN 60529)	IP 20	IP 20
Housing material	stainless steel	stainless steel



DataPro-ISDN-aP

Overvoltage protection for RJ45 for ISDN S0 interface.

- For ISDN interfaces
- Applicable at the boundaries LPZ 0B - 2 and higher
- RJ45 socket
- 2-stage, (5-point) coarse and fine protective circuit
- Without coding
- Test standard: IEC 61643-21 / EN 61643-21

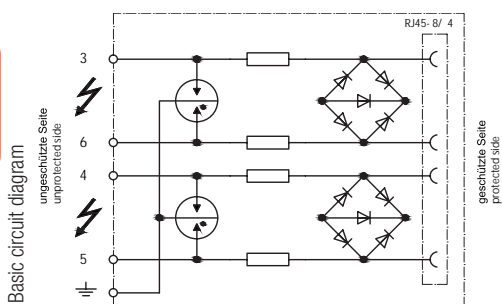

Technical Data	DataPro ISDN-aP
Article-No.	24 00 13
IEC category/EN type	C2 / C1 / C3
Nominal voltage DC	UN 50 V=
Max. continuous operating voltage DC	Uc ± 6,2 V=
Nominal current	IL 1,5 A
C2 nominal discharge current (8/20)	In 5 kA
Protection level at In (line-line)	Up ≤ 36 V
Protection level at In (line-earth)	Up ≤ 460 V
Response time	tA ≤ 500/≤ 100 ns
Insertion loss in a 100 Ω system, typical	0.1 dB up to 10 MHz
Max. frequency (-3 dB)	fG 80 MHz
Capacitance/1 MHz, typ.	C ≤ 25/ ≤ 15 pF
Operating temperature range	TU -40 - +80 °C
Type of connection	screw-type terminals / RJ45
Degree of protection (IEC EN 60529)	IP 20

DataPro-TAE/NFN-aP

Surge protective device in a housing for surface mounting for the protection of analog telecommunication wires such as analog TAE or DSL interfaces.

- For analog telephone lines
- Fax, modem, answering machine
- Emergency dialling devices
- Applicable at the boundaries LPZ 0B - 2 and higher
- TAE connector, code NFN
- Standard of the Deutsche Telekom
- Test standard: IEC 61643-21 / EN 61643-21
- 2-stage, (5-point) coarse and fine protective circuit

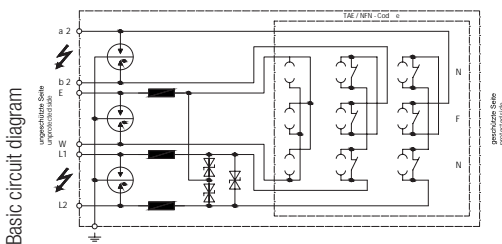

Technical Data	DataPro-TAE/NFN-aP
Article-No.	24 00 04
IEC category/EN type	C2 / C1 / C3
Nominal voltage DC	UN 60 V=
Max. continuous operating voltage DC	Uc 185 V=
Nominal current	IL 1,5 A
C2 nominal discharge current (8/20 μs) total	In 5 kA
Protection level at In (line-line)	Up ≤ 300 V
Protection level at In (line-earth)	Up ≤ 450 V
Response time (Line-Line)/(Line-Earth)	tA ≤ 10 / ≤ 50 ns
Max. frequency (3 dB)	fG 1,5 MHz
Resistance per path	R 1 Ω
Operating temperature range	TU -40 - +80 °C
Type of connection	Screw-type terminal/TAE
Degree of protection (IEC EN 60529)	IP 20

Dimension drawing, see pages 194 to 198



- LSA surge voltage magazines with 10 or 20 gas-filled surge arresters (coarse protection)
- Applicable at the LPZ transition point OA-1 and higher, depending on type
- The magazines can be connected to both the connection and the disconnection module

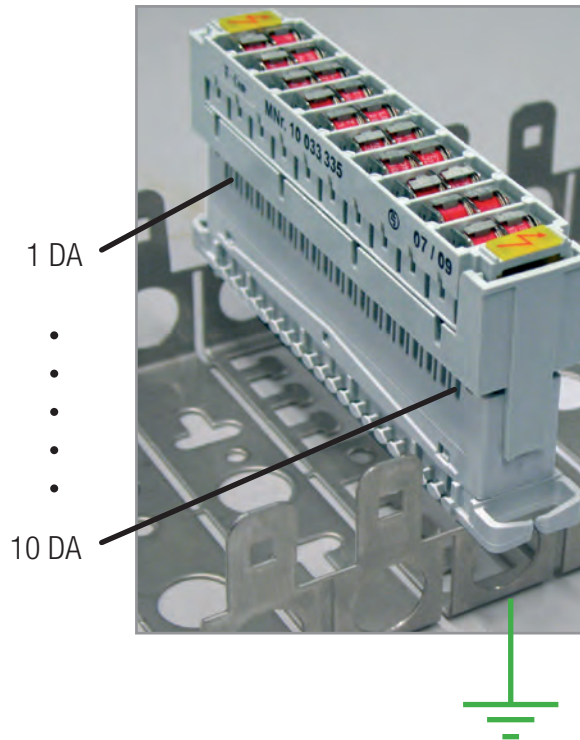
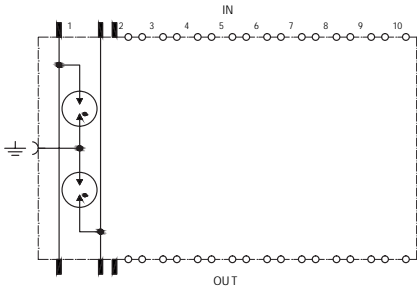

- Surge voltage protection connector (coarse and fine protection) DP 1LSA or DP 10LSA to equip the LSA disconnection module (white) of the construction form 2
- Applicable at the LPZ transition point OA-1 and higher, depending on type
- The surge voltage protection connectors are only pluggable to the disconnection module
- Earthing by a grounding bar, which is connected to the backmount frame via the disconnection module.

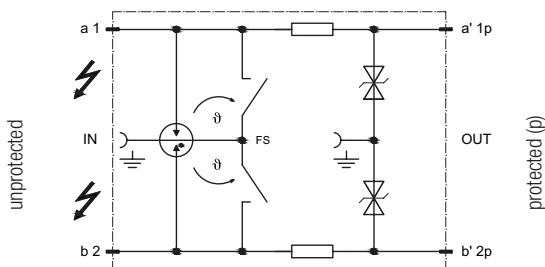

example: DP 1LSA-12

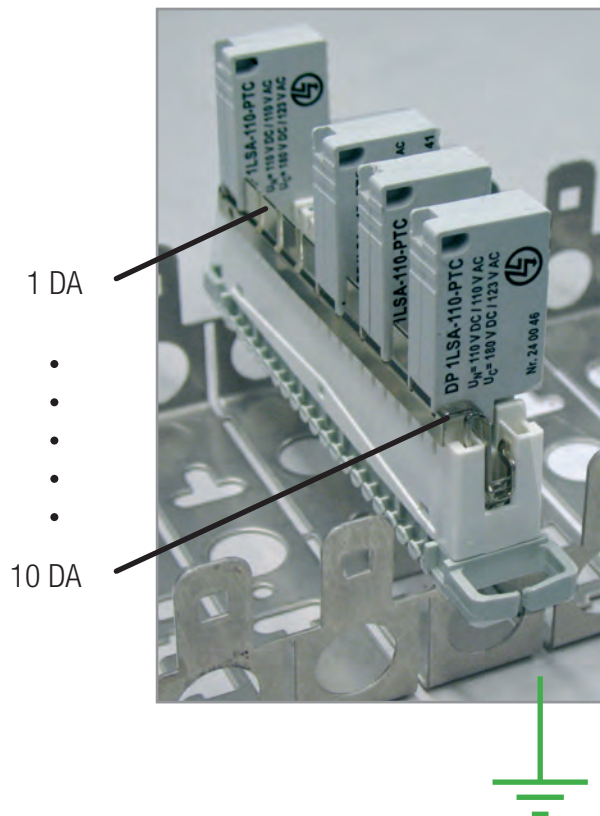



SPD according to test category D1+C2

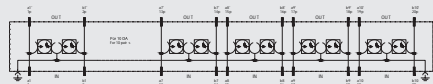
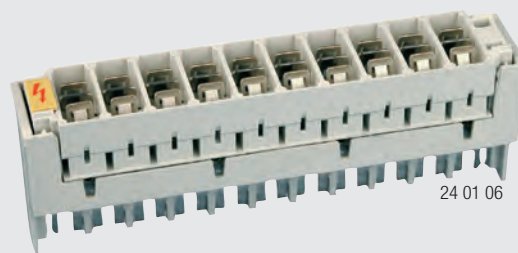

TelPro LSA 2/10-2E 8x6

LSA surge voltage protection for two-electrode arresters (8x6 mm) for LSA (IDC) connection and disconnection modules.

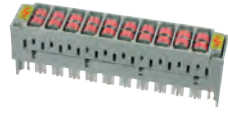

- Empty and filled magazines
- Magazines are fitted with 20 gas-filled surge arresters (GDT) each
- Integrated fail-safe function (24 01 14)

Basic circuit diagram

				
Technical Data	TelPro LSA 2/10-2E 8x6	TelPro LSA-2EH90-10kA	TelPro LSA-2EH230-10kA	TelPro LSA-2EH230F-10kA
Article-No.	24 01 06	24 01 17	24 01 13	24 01 14
Nominal DC sparkover voltage	UagN - V=	90 V=	230 V=	230 V=
Impulse sparkover voltage at 1 kV/μs	Uas - V	< 550 V	< 650 V	< 650 V
Nominal alternating discharge current	Iwn - A	10 A	10 A	10 A
D1 lightning impulse current (10/350)	Iimp - kA	2,5 kA	2,5 kA	2,5 kA
C2 Nominal discharge current (8/20)	In - kA	10 kA	10 kA	10 kA
C3 protection level line-PE at 1kV/μs	Up - V	≤ 550 V	≤ 650 V	≤ 650 V
Capacitance, line-earth	C - nF	≤ 1,5 at 1MHz nF	≤ 1,5 pF at 1MHz nF	≤ 1,5 pF at 1MHz nF
Operating temperature range	TU -40 - +80 °C	-40 - +80 °C	-40 - +80 °C	-40 - +80 °C

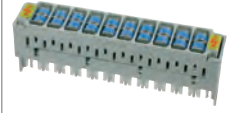
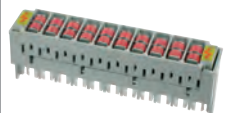
		
Technical Data	TelPro LSA-2EL230-20kA	TelPro LSA-2EH350-10kA
Article-No.	24 01 15	24 01 16
Nominal DC sparkover voltage	UagN 230 V=	350 V=
Impulse sparkover voltage at 1 kV/μs	Uas < 550 V	< 800 V
Nominal alternating discharge current	Iwn 20 A	20 A
D1 lightning impulse current (10/350)	Iimp 5 kA	2,5 kA
C2 Nominal discharge current (8/20)	In 20 kA	10 kA
C3 protection level line-PE at 1kV/μs	Up ≤ 550 V	≤ 800 V
Capacitance, line-earth	C ≤ 1,5 pF at 1MHz nF	≤ 1,5 at 1MHz nF
Operating temperature range	TU -40 - +80 °C	-40 - +80 °C

Dimension drawing, see pages 194 to 198

SPD according to test category D1+C2

TelPro LSA 2/10-3E 8x13

LSA surge voltage protection for three-electrode arresters (8x13 mm or 8x10 mm) for LSA (IDC) connection and disconnection modules.

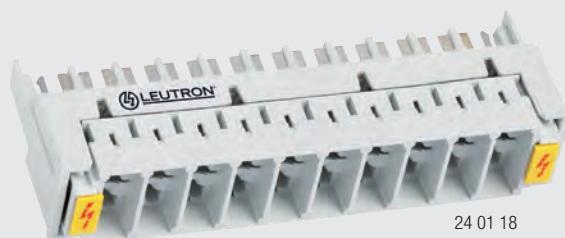

24 01 18

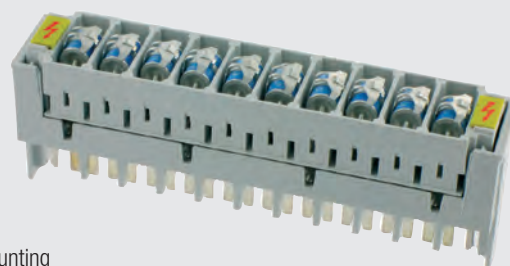





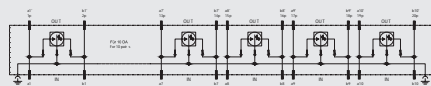

24 01 25

Basic circuit diagram

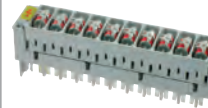

- Surge protective devices for LSA mounting
- Magazines are fitted with 10 gas-filled surge arrester (GDT) each
- Integrated fail-safe function (24 01 23, 24 01 25, 24 01 27)
- Operating temperature range: -40 - +80 °C

				
Technical Data	TelPro LSA 2/10-3E 8x13	TelPro LSA-3EH90E-10kA	TelPro LSA-3EH90F1E-10kA	TelPro LSA 2/10-3EH230E-10kA
Article-No.	24 01 18	24 01 26	24 01 27	24 01 19
Nominal DC sparkover voltage	UagN - V=	90 V=	90 V=	230 V=
Impulse sparkover voltage at 1 kV/μs	Uas - V	< 550 V	< 550 V	< 650 V
Nominal alternating discharge current	Iwn - A	10 A	10 A	10 A
D1 lightning impulse current (10/350) gesamt	Itotal - kA	5 kA	5 kA	5 kA
D1 lightning impulse current (10/350 μs) per line	Iimp - kA	2,5 kA	2,5 kA	2,5 kA
C2 nominal discharge current (8/20 μs) total	Imax - kA	10 kA	10 kA	10 kA
C2 Nominal discharge current (8/20) per line	In - kA	5 kA	5 kA	5 kA
C3 protection level line-line at 1kV/μs	Up - V	≤ 450 V	≤ 500 V	≤ 500 V
C3 protection level line-PE at 1kV/μs	Up - V	≤ 450 V	≤ 500 V	≤ 500 V
Capacitance, line-earth	C - nF	≤ 1,5 at 1MHz nF	≤ 1,5pF at 1MHz nF	≤ 1,5 at 1MHz nF

			
Technical Data	TelPro LSA-3EH230F1E-10kA	TelPro LSA-3EL230E-20kA	TelPro LSA-3EL230F1E-20kA
Article-No.	24 01 23	24 01 24	24 01 25
Nominal DC sparkover voltage	UagN 230 V=	230 V=	230 V=
Impulse sparkover voltage at 1 kV/μs	Uas < 650 V	< 550 V	< 550 V
Nominal alternating discharge current	Iwn 10 A	20 A	20 A
D1 lightning impulse current (10/350)	Itotal 5 kA	10 kA	10 kA
D1 lightning impulse current (10/350) per line	Iimp 2,5 kA	5 kA	5 kA
C2 nominal discharge current (8/20) total	Imax 10 kA	20 kA	20 kA
C2 Nominal discharge current (8/20) per line	In 5 kA	10 kA	10 kA
C3 protection level line-line at 1kV/μs	Up ≤ 500 V	≤ 500 V	≤ 500 V
C3 protection level line-PE at 1kV/μs	Up ≤ 500 V	≤ 500 V	≤ 500 V
Capacitance, line-earth	C ≤ 1,5 at 1MHz nF	≤ 1,5 at 1MHz nF	≤ 1,5 at 1MHz nF

Dimension drawing, see pages 194 to 198



Magazine for HVT 71

MTH and MTL series



The surge protection magazines of series MTH and MTL are fitted with high quality gas discharge tubes. They are available in variations of 90 V ac and 230 V ac executions.

They are designed specially for HVT 71 application of Siemens main distribution in telecom and data line systems.

The integrated fail-safe behaviour protects against dangerous ac influences.



- impulse current resistance 10/ 20 kA per line
- Stable functioning
- Magazines are fitted with 10 gas-filled surge arrester (GDT) each
- Long service life
- For 5 double lines

				without fig.
Technical Data	MTH 90	MTH 230	MTL 90	MTL 230
Article-No.	95 15 00	95 15 01	95 15 02	95 15 03
Nominal DC sparkover voltage at 100 V/s	U _{agN} 90 V DC	230 V DC	90 V DC	230 V DC
Tolerance of V _{sdCN}	± 20%	± 20%	± 20%	± 20%
Impulse sparkover voltage, typ. value at 100 V/μs	U _{as} < 450 V DC	< 500 V DC	< 450 V DC	< 500 V DC
Impulse sparkover voltage, typ. value at 1 kV/μs	U _{as} < 550 V DC	< 650 V DC	< 550 V DC	< 650 V DC
Nominal impulse discharge current (8/20)GDT/magazine	I _n 10 / 5 kA	10 / 5 kA	20 / 5 kA	20 / 5 kA
Max. impulse discharge current (8/20) GDT/magazine	I _{max} 12 / 7,5 kA	12 / 7,5 kA	25 / 7,5 kA	25 / 7,5 kA
Alternating discharge current 9 cycles, 50Hz GDT	I _w 65 A	65 A	100 A	100 A
Nominal alternating discharge current	I _{wN} 5 A	5 A	5 A	5 A
Glow voltage (average at 10 mA)	U _{gl} ~ 60 V	~ 60 V	~ 60 V	~ 60 V
Arc - voltage at 1 A	U _{bo} ~ 15 V	~ 15 V	~ 15 V	~ 15 V
Max. Operating current magazine	I _L 2 A	2 A	2 A	2 A
Insulation resistance GDT/magazine	R _{is} > 10 A	> 10 A	> 10 A	> 10 A
Capacitance at 1 MHz GDT	C < 1,5 GΩ	< 1,5 GΩ	< 1,5 GΩ	< 1,5 GΩ
Climatic category / Relative humidity (DIN IEC 60068-1)	40/90/21, 10%...95% rh			
Operating temperature range	TU -40 - +90 °C	-40 - +90 °C	-40 - +90 °C	-40 - +90 °C
Net weight / pc	ca. 45 g	ca. 45 g	ca. 45 g	ca. 45 g
Dimensions (L x W x H)	ca. 95,8 mm x 48,6 mm x 9 mm			
Material magazine	up to 160°C solid plastic (PBF Crastin), increased with glass fiber			
Fitted GDT:	10x 2EH 90	10x 2EH 230	10x 2EL 90	10x 2EL 230

Dimension drawing, see pages 194 to 198



SPD according to test category D1+C2

TelPro LSA 2/10-2E 8x20

LSA surge voltage protection for two-electrode arresters (8x20 mm) for LSA (IDC) connection and disconnection modules.



Basic circuit diagram

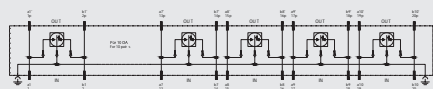

- Surge protective devices for LSA mounting
- Magazine sind mit je 20 ÜsAg bestückt
- Integrated fail-safe function

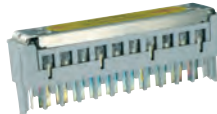
		without fig.	without fig.	
Technical Data	TelPro LSA 2/10-2E 8x20	TelPro LSA-2EY90-20kA	TelPro LSA 2EY230-20kA	TelPro LSA-2EY350-20kA
Article-No.	24 01 28	24 01 31	24 01 29	24 01 32
Nominal DC sparkover voltage	U _{agN} - V=	90 V=	230 V=	350 V=
Impulse sparkover voltage at 1 kV/μs	U _{as} - V	< 550 V	< 550 V	< 700 V
Nominal alternating discharge current	I _{wn} - A	20 A	20 A	20 A
D1 lightning impulse current (10/350 μs)	I _{imp} - kA	5 kA	5 kA	5 kA
C2 Nominal discharge current (8/20)	I _n - kA	20 kA	20 kA	20 kA
C3 protection level line-PE at 1kV/μs	U _p - V	≤ 550 V	≤ 550 V	≤ 700 V
Capacitance, line-earth	C - nF	≤ 1,5 at 1MHz nF	≤ 1,5 at 1MHz nF	≤ 1,5 at 1MHz nF
Operating temperature range	TU -40 - +80 °C	-40 - +80 °C	-40 - +80 °C	-40 - +80 °C

Dimension drawing, see pages 194 to 198



SPD according to test category C2+C1

DataPro 1LSA / DataPro 1LSA-PTC / DataPro 1LSA-T110FS-PTC

Surge voltage and surge current protection for communication and data transmission lines. Protection connector (1DA) with surge current protection via PTC thermistors, for analogue, ISDN and ADSL lines. Integrated coarse and fine protection and fail-safe contact.

- Execution of various voltage
- PTC-execution: Surge current protection via PTC thermistors
- PTC-execution: Suitable for DC and AC application
- Two-step, coarse and fine protection
- Fail-safe thermal overload protection
- Grounding via connector or LSA backmount frame

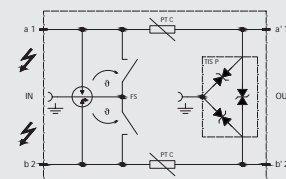
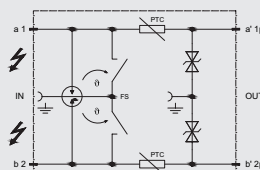
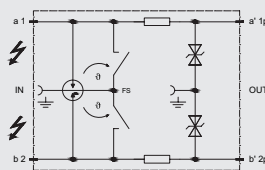

DataPro 1LSA

DataPro 1LSA-PTC

DataPro 1LSA-T110FS-PTC

Basic circuit diagram

Technical Data	DP 1LSA-5	DP 1LSA-12	DP 1LSA-15	DP 1LSA-24
Article-No.	24 00 31	24 00 32	24 00 33	24 00 34
Nominal voltage DC	UN 5 V=	12 V=	15 V=	24 V=
Max. continuous operating voltage DC	Uc 6 V=	14 V=	19 V=	29 V=
Nominal alternating voltage	UN 3 V~	8 V~	12 V~	15 V~
Max. continuous operating voltage AC	Uc 4 V~	10 V~	12 V~	20 V~
Nom. Operating current at 25° C	IL 150 mA	150 mA	150 mA	100 mA
C2 Nominal discharge current (8/20)	In 5 kA	5 kA	5 kA	5 kA
Max. impulse discharge current (8/20)	Imax 10 kA	10 kA	10 kA	10 kA
Protection level at In (line-PG)	Up ≤ 15 V	≤ 28 V	≤ 40 V	≤ 60 V
Residual voltage at 1 kV/μs (line-PG)	Ures ≤ 12 V	≤ 22 V	≤ 31 V	≤ 46 V
Response time	tA ≤ 1 ns	≤ 1 ns	≤ 1 ns	≤ 1 ns
Capacitance, line-earth	C ≤ 4,5 nF	≤ 2,5 nF	≤ 2 nF	≤ 1,4 nF
Series impedance per line at 25°C	R 10 Ω	15 Ω	22 Ω	27 Ω
Max. transmission frequency	fg 1,6 MHz	2,4 MHz	3,1 MHz	4,2 MHz
Grounding/Earthing	via grounding bar and isolation unit on LSA backmount frame			
Operating temperature range	TU -40 - +80 °C	-40 - +80 °C	-40 - +80 °C	-40 - +80 °C
Enclosure material / colour	Thermoplastic (POCAN) UL 94 V0, grey			

Dimension drawing, see pages 194 to 198

SURGE PROTECTION FOR INFORMATION TECHNOLOGY AND TELECOMMUNICATION

SURGE PROTECTIVE DEVICES FOR LSA MOUNTING



Technical Data	DP 1LSA-30	DP 1LSA-48	DP 1LSA-60	DP 1LSA-110
Article-No.	24 00 36	24 00 37	24 00 38	24 00 39
Nominal voltage DC	UN 30 V=	48 V=	60 V=	110 V=
Max. continuous operating voltage DC	Uc 33 V=	80 V=	100 V=	180 V=
Nominal alternating voltage	UN 21 V~	24 V~	48 V~	110 V~
Max. continuous operating voltage AC	Uc 23 V~	56 V~	70 V~	123 V~
Nom. Operating current at 25° C	IL 100 mA	150 mA	150 mA	150 mA
C2 Nominal discharge current (8/20)	In 5 kA	5 kA	5 kA	5 kA
Max. impulse discharge current (8/20)	Imax 10 kA	10 kA	10 kA	10 kA
Protection level at In (line-PG)	Up ≤ 70 V	≤ 240 V	≤ 300 V	≤ 600 V
Residual voltage at 1 kV/μs (line-PG)	Ures ≤ 54 V	≤ 130 V	≤ 180 V	≤ 230 V
Response time	tA ≤ 1 ns	≤ 25 ns	≤ 25 ns	≤ 25 ns
Capacitance, line-earth	C ≤ 1 nF	≤ 300 nF	≤ 250 nF	≤ 100 nF
Series impedance per line at 25°C	R 27 Ω	4,7 Ω	4,7 Ω	4,7 Ω
Max. transmission frequency	fg 4,5 MHz	5 MHz	5 MHz	10 MHz
Grounding/Earthing	via grounding bar and isolation unit on LSA backmount frame			
Operating temperature range	TU -40 - +80 °C	-40 - +80 °C	-40 - +80 °C	-40 - +80 °C
Enclosure material / colour	Thermoplastic (POCAN) UL 94 V0, grey			

Technical Data	DP 1LSA-5-PTC	DP 1LSA-12-PTC	DP 1LSA-15-PTC	DP 1LSA-24-PTC
Article-No.	24 00 40	24 00 41	24 00 42	24 00 43
Nominal voltage DC	UN 5 V=	12 V=	15 V=	24 V=
Max. continuous operating voltage DC	Uc 6 V=	14 V=	19 V=	29 V=
Nominal alternating voltage	UN 3 V~	8 V~	12 V~	15 V~
Max. continuous operating voltage AC	Uc 4 V~	10 V~	12 V~	20 V~
Nom. Operating current at 25° C	IL 150 mA	150 mA	150 mA	150 mA
C2 Nominal discharge current (8/20)	In 5 kA	5 kA	5 kA	5 kA
Max. impulse discharge current (8/20)	Imax 10 kA	10 kA	10 kA	10 kA
Protection level at In (line-PG)	Up ≤ 15 V	≤ 28 V	≤ 40 V	≤ 60 V
Residual voltage at 1 kV/μs (line-PG)	Ures ≤ 12 V	≤ 22 V	≤ 31 V	≤ 46 V
Response time	tA ≤ 1 ns	≤ 1 ns	≤ 1 ns	≤ 1 ns
Thermal overload protection	Thermal fail-safe (short-circuit spring) and PTC			
Capacitance, line-earth	C ≤ 4,5 nF	≤ 2,5 nF	≤ 2 nF	≤ 1,4 nF
Series impedance per line at 25°C	R 9 - 11 Ω	9 - 11 Ω	9 - 11 Ω	9 - 11 Ω
Max. transmission frequency	fg 1,6 MHz	2,4 MHz	3,1 MHz	4,2 MHz
Grounding/Earthing	via grounding bar and isolation unit on LSA backmount frame			
Operating temperature range	TU -40 - +80 °C	-40 - +80 °C	-40 - +80 °C	-40 - +80 °C
Enclosure material / colour	Thermoplastic (POCAN) UL 94 V0, grey			

Dimension drawing, see pages 194 to 198



SURGE PROTECTION FOR INFORMATION TECHNOLOGY AND TELECOMMUNICATION

SURGE PROTECTIVE DEVICES FOR LSA MOUNTING

Technical Data	DP 1LSA-48-PTC	DP 1LSA-60-PTC	DP 1LSA-110-PTC	DP 1LSA-T110FS-PTC
Article-No.	24 00 44	24 00 45	24 00 46	24 00 48
Nominal voltage DC	UN 48 V=	60 V=	110 V=	110 V=
Max. continuous operating voltage DC	Uc 80 V=	100 V=	180 V=	180 V=
Nominal alternating voltage	UN 24 V~	48 V~	110 V~	110 V~
Max. continuous operating voltage AC	Uc 56 V~	70 V~	123 V~	123 V~
Nom. Operating current at 25° C	IL 150 mA	150 mA	150 mA	150 mA
C2 Nominal discharge current (8/20)	In 5 kA	5 kA	5 kA	5 kA
Max. impulse discharge current (8/20)	I _{max} 10 kA	10 kA	10 kA	10 kA
Protection level at I _n (line-PG)	U _p ≤ 240 V	≤ 300 V	≤ 600 V	≤ 300 V
Residual voltage at 1 kV/μs (line-PG)	U _{res} ≤ 130 V	≤ 180 V	≤ 230 V	≤ 300 V
Response time	t _A ≤ 25 ns	≤ 25 ns	≤ 25 ns	≤ 5 ns
Thermal overload protection	Thermal fail-safe (short-circuit spring) and PTC			
Capacitance, line-earth	C ≤ 300 nF	≤ 250 nF	≤ 100 nF	≤ 60 pF
Series impedance per line at 25° C	R 9 - 11 Ω	9 - 11 Ω	9 - 11 Ω	9 - 11 Ω
Max. transmission frequency	f _g 5 MHz	5 MHz	10 MHz	> 20 MHz
Grounding/Earthing	via grounding bar and isolation unit on LSA backmount frame			
Operating temperature range	TU -40 - +80 °C	-40 - +80 °C	-40 - +80 °C	-40 - +80 °C
Enclosure material / colour	via grounding bar and isolation unit on LSA backmount frame			

DataPro 1LSA-180FS

Lightning and surge protection for telephone installations. Pluggable module for LSA (IDC) disconnection modules. Surge voltage protection connector for 1 DA, for ADSL, ISDN UK0 or a/b lines, with fail-safe contact.

Basic circuit diagram

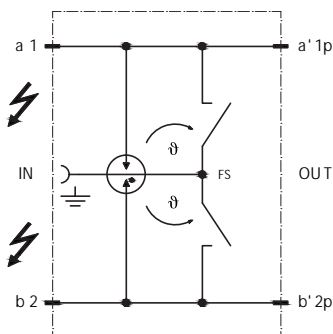

Technical Data	DP 1LSA-180FS	DP 1LSA-TK180FS
Article-No.	24 00 47	24 00 49
Nominal voltage DC	UN 110 V=	110 V=
Max. continuous operating voltage DC	Uc 180 V=	180 V=
Max. continuous operating voltage AC	Uc 127 V~	127 V~
Nominal DC sparkover voltage at 100V/s	U _{agN} 230 (±20%) V=	230 ±20% V=
C3 Protection level at 1 kV/μs (line-earth)	U _p ≤450 V	≤ 600 V
Nom. Operating current at 25° C	IL 150 mA	1000 mA
C2 Nominal discharge current (8/20)	In 5 kA	5 kA
Max. impulse discharge current (8/20)	I _{max} 10 kA	10 kA
Alternating discharge current 9 cycles, 50 Hz	I _w 50 A	40 A
Response time Ad1 - Ad2-PG	t _A ≤ 50 ns	≤ 50 ns
Self-capacitance line-earth at 1MHz	C ≤ 3 pF	≤ 5 pF
Max. transmission frequency	f _g 50 MHz	> 30 MHz
Thermal overload protection	Thermal fail-safe (short-circuit spring)	
Grounding/Earthing	via grounding bar and isolation unit on LSA backmount frame	
Operating temperature range	TU -40 - +80 °C	-40 - +80 °C
Enclosure material / colour	Thermoplastic (POCAN) UL 94 V0, grey	

Dimension drawing, see pages 194 to 198





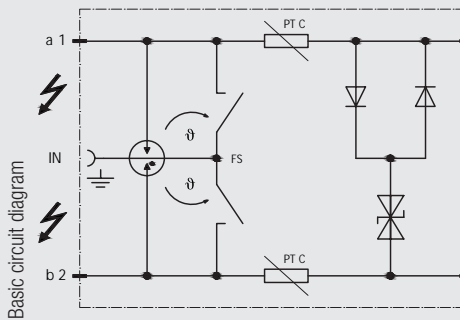

SPD according to test category C2+C1

DP 1LSA-CxxFS-PTC

Surge voltage protector for data and signal lines in measuring systems and automatic control devices. Surge voltage protection connector for 1 DA with surge current protection via PTC thermistors and fail-safe contact for higher frequency transmission range for measuring systems and automatic control devices, for LSA (IDC) disconnection modules.



- Surge current protection via PTC thermistors
- High impulse discharge current of 10 kA (8/20)
- Suitable for DC and AC application

				
Technical Data	DP 1LSA-C5FS-PTC	DP 1LSA-C12FS-PTC	DP 1LSA-C15FS-PTC	DP 1LSA-C24FS-PTC
Article-No.	24 00 63	24 00 64	24 00 65	24 00 66
Nominal voltage DC	UN 5 V=	12 V=	15 V=	24 V=
Max. continuous operating voltage DC	UC 6 V=	14 V=	19 V=	29 V=
Nominal alternating voltage	UN o.A. V~	8 V~	12 V~	15 V~
Max. continuous operating voltage AC	UC o.A. V~	10 V~	12 V~	20 V~
Nom. Operating current at 25° C	IL 150 mA	150 mA	150 mA	150 mA
C2 Nominal discharge current (8/20)	In 5 kA	5 kA	5 kA	5 kA
Max. impulse discharge current (8/20)	Imax 10 kA	10 kA	10 kA	10 kA
Protection level at In (line-line)	Up ≤ 11 V	≤ 22 V	≤ 31 V	≤ 46 V
Protection level at In (line-PG)	Up ≤ 600 V	≤ 600 V	≤ 600 V	≤ 600 V
Response time a-b	tA ≤ 1 ns	≤ 1 ns	≤ 1 ns	≤ 1 ns
Response time a, b to PG	100 ns	< 100 ns	< 100 ns	< 100 ns
Transversal Capacitance	C ≤ 30 pF	≤ 30 pF	≤ 30 pF	≤ 30 pF
Series impedance per line at 25°C	R 9 - 11 Ω	9 - 11 Ω	9 - 11 Ω	9 - 11 Ω
Max. transmission frequency	fg ≤ 30 MHz	≤ 30 MHz	≤ 30 MHz	≤ 30 MHz
Thermal overload protection	Thermal fail-safe (short-circuit spring) and PTC			
Grounding/Earthing	via grounding bar and isolation unit on LSA backmount frame			
Operating temperature range	TU -40 - +80 °C	-40 - +80 °C	-40 - +80 °C	-40 - +80 °C

Dimension drawing, see pages 194 to 198



SURGE PROTECTION FOR INFORMATION TECHNOLOGY AND TELECOMMUNICATION

SURGE PROTECTIVE DEVICES FOR LSA MOUNTING



Technical Data	DP 1LSA-C48FS-PTC	DP 1LSA-C60FS-PTC
Article-No.	24 00 61	24 00 62
Nominal voltage DC	UN 48 V=	60 V=
Max. continuous operating voltage DC	Uc 80 V=	100 V=
Nominal alternating voltage	UN 24 V~	48 V~
Max. continuous operating voltage AC	Uc 56 V~	70 V~
Nom. Operating current at 25° C	IL 150 mA	150 mA
C2 Nominal discharge current (8/20)	In 5 kA	5 kA
Max. impulse discharge current (8/20)	Imax 10 kA	10 kA
Protection level at In (line-line)	Up ≤ 130 V	≤ 180 V
Protection level at In (line-PG)	Up ≤ 600 V	≤ 600 V
Response time a-b	tA ≤ 25 ns	≤ 25 ns
Response time a, b zu PG	< 100 ns	<100 ns
Transversal Capacitance	C ≤ 30 pF	≤ 30 pF
Series impedance per line at 25°C	R 9 - 11 Ω	9 - 11 Ω
Max. transmission frequency	fg ≤ 30 MHz	≤ 30 MHz
Thermal overload protection	Thermal fail-safe (short-circuit spring) and PTC	
Grounding/Earthing	via grounding bar and isolation unit on LSA backmount frame	
Operating temperature range	TU -40 - +80 °C	-40 - +80 °C

Dimension drawing, see pages 194 to 198



SPD according to test category C2+C1

DataPro 10LSA



Pluggable surge arrester for telecommunication lines with 10 pair of wires (DA) for LSA (IDC) disconnection modules.

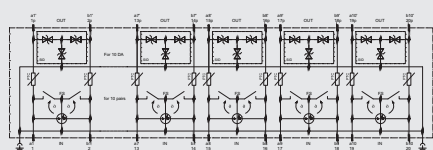

Basic circuit diagram



- Surge arrester for telecommunications
- Protection for up to 10 pair of wires (DA)
- Integrated coarse and fine protection
- Surge voltage protection against longitudinal and transverse voltages

			
Technical Data	DP 10LSA-12V	DP 10LSA-24V	DP 10LSA-110
Article-No.	24 00 25	24 00 27	24 01 40
Nominal voltage DC	UN 12 V=	24 V=	110 V=
Max. continuous operating voltage DC	Uc 14 V=	29 V=	180 V=
Max. continuous operating voltage AC	Uc 10 V~	21 V~	
Residual voltage at 1kV/μs	Ures ≤ 22 V	≤ 46 V	≤ 250 V
Nom. Operating current at 25° C	IL 150 mA	150 mA	145 mA
C2 Nominal discharge current (8/20)	In 5 kA	5 kA	5 kA
Max. impulse discharge current (8/20)	Imax 10 kA	10 kA	10 kA
Protection level at In	Up ≤ 28 V	≤ 60 V	220 V
Response time	tA ≤ 1 ns	≤ 1 ns	< 1 ns
Thermal fail-safe response time at 230VAC/23A and ambient temperature 25°C	TA ≤ 2 s	≤ 2 s	<2 s
Capacitance, line-earth	C < 2,5 nF	< 1,4 nF	< 0,1 nF
Serial inductive impedance at 25°C	L 47 μH	47 μH	47 μH
Series impedance per line at 25°C	R 15 Ω	27 Ω	3-6 Ω
Max. transmission frequency	fg < 2,4 MHz	≤ 4,2 MHz	≤ 1,2 MHz
Grounding/Earthing	LSA backmount frame		
Operating temperature range	TU -40 - +80 °C	-40 - +80 °C	-40 - +80 °C
Enclosure material / colour	Thermoplast: grau oder gelb		

Dimension drawing, see pages 194 to 198



SPD according to test category C2+C1

DataPro 10LSA-PTC

Pluggable surge arrester for telecommunication lines with 10 pair of wires (DA) for LSA (IDC) disconnection modules.

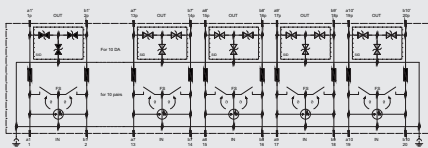
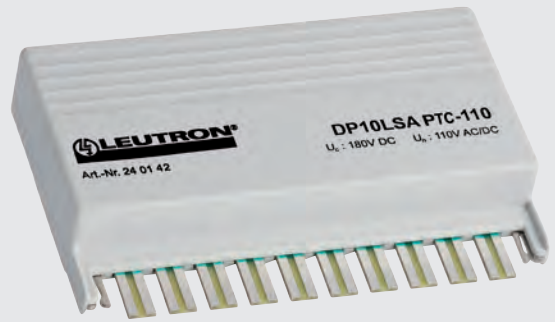

Basic circuit diagram

- Surge arrester for telecommunications
 - Protection for up to 10 pair of wires (DA)
 - Integrated coarse and fine protection
- Surge voltage protection against longitudinal and transverse voltages
 - Surge current protection via PTC thermistors

Technical Data	DP 10LSA-PTC-12V	DP 10LSA-PTC-24V	DP 10LSA-PTC 110
Article-No.	24 00 26	24 00 28	24 01 42
Nominal voltage DC	UN 12 V=	24 V=	110 V=
Max. continuous operating voltage DC	Uc 14 V=	29 V=	180 V=
Max. continuous operating voltage AC	Uc 10 V~	21 V~	180 V~
Residual voltage 1kV/μs	Ures ≤ 22 V	≤ 46 V	≤ 250 V
Nom. Operating current at 25° C	IL 150 mA	150 mA	145 mA
C2 Nominal discharge current (8/20)	In 5 kA	5 kA	5 kA
Max. impulse discharge current (8/20)	Imax 10 kA	10 kA	10 kA
Protection level at In	Up ≤ 28 V	≤ 60 V	220 V
Response time	tA ≤ 1 ns	≤ 1 ns	≤ 1 ns
Capacitance, line-earth	C < 2,5 nF	< 1,4 nF	< 0,1 nF
Series impedance per line at 25°C	R 9 - 11 Ω	9 - 11 Ω	9 - 11 Ω
Max. transmission frequency	fg < 2,4 MHz	≤ 4,2 MHz	≤ 2 MHz
Operating temperature range	TU -40 - +80 °C	-40 - +80 °C	-40 - +80 °C
Thermal overload protection	Thermal fail-safe (short-circuit spring) and PTC		
Dimensions (L x W x H)	110 x 22 x 72 mm	110 x 22 x 72 mm	110 x 22 x 72 mm
Grounding/Earthing	via grounding bar and isolation unit on LSA backmount frame		
Enclosure material / colour	Thermoplastic: grey or yellow		

Dimension drawing, see pages 194 to 198

Accessories for LSA Technology

LSA Connection Module

Each module can hold 10 DA at the cable and allocation side for a permanent connection. LSA magazines filled with gas-filled surge arresters can be plugged in. The connection module is grey.

- Corresponds with IEC 60352-4 and DIN 41611-6
- Wiring with two wires of same diameter is possible
- Amply dimensioned elastic arrangement of the wiring

	
Technical Data	LSA 2/10-AN
Article-No.	24 01 00
Withstand voltage	2 kV
Volume resistance	< 10 mΩ
Conductor diameter, solid wire	0,4-0,8 AWG 26-20 mm
Insulation resistance	Ris 5x 10.000 MΩ
External diameter of insulation	0,7-1,5 mm

LSA Disconnection Module

Each module can hold 10 DA at the cable and allocation side. To be equipped with surge voltage protection connectors (coarse and fine protection) DP 1LSA or DP 10LSA. Applicable at the LPZ transition point 1-2 and higher. The disconnection module is white.

	
Technical Data	LSA 2/10-TR
Article-No.	24 01 02
Withstand voltage	2 kV
Volume resistance	< 10 mΩ
Insulation resistance	Ris 5x 10.000 MΩ
Conductor diameter	0,4 -0,8 mm
External diameter of insulation	0,7-1,5 mm

Further LSA parts



LSA 2/10-ER38-rot (Art.No. 24 01 04)
LSA ground module to connect 38 earthing connectors and shields.



LSA 2/10-ES (Art.No. 24 01 33)
Pluggable grounding rail: For 10DA connection modules serving as connection between LSA backmount frame and 1 DA surge voltage (+surge current) protection connector Installation: Plug into front connection modules, bonding to ground via LSA backmount frame



LSA 2/10 KS-120 (Art.No.24 01 36)
LSA edge protection profile for backmount frame (plastic)



LSA 2/10 KSR (Art.No. 24 01 08)
LSA 2/10 hinged label holder (plastic)



LSA DIN ADAPT (Art.No. 24 01 37)
LSA 2/10 DIN rail adapter. Adapter metal line with M5 screw thread (without screw). Used to fix backmount frame or connection modules onto 35 mm DIN rails..



LSA 2/10-MW10-25/22 (Art.No.24 01 10)
LSA backmount frame 10 x 10DA (modular) stainless metal. Plug space for 10 pcs of LSA 2/10 10DA connection modules 25 mm grid / depth 22 mm, easily detachable upon individual requirements, available up to a size of 78 connection modules.



LSA 2/10 AD (Art.No.24 01 09)
Magazine cover for protection against dust and unwanted contact; Transparent for visual inspection of the arrester Magazin

Product	LSA 2/10 KSR	LSA 2/10 AD	LSA 2/10-MW10-25/22	LSA DIN ADAPT	LSA 2/10 KS-120	LSA 2/10-ES	LSA 2/10-ER38-rot
Article-No.	24 01 08	24 01 09	24 01 10	24 01 37	24 01 36	24 01 33	24 01 04

Dimension drawing, see pages 194 to 198

EVERYTHING FOR THE PROTECTION OF TRANSMISSION AND RECEIVING SYSTEMS

Due to an expansion of its product range Leutron now offers devices that cover all established interfaces and frequency ranges. Transmitting and receiving systems with broadband and narrowband signals up to 6 GHz as well as base stations for mobile communications and broadcasting systems can be protected. The protective devices combine a very low protection level with an optimum transmission of the wanted signal.

Special solutions for uncommon interfaces are available on request.



FAULT-FREE TRANSMITTING AND RECEIVING OPERATION:

- Protective devices with gas-filled surge protectors, impedance-adjusted for frequency ranges up to 6 GHz – simultaneous transmission of a DC supply voltage possible
- Protective devices for radio installations with narrowband signals with Lambda/4 Stubline technology. This results in a high damping of the interfering noise, whilst the wanted signal is transmitted without disturbance



High-quality protective devices for base stations for mobile communications with high capacity of absorbing interference energy.

SURGE PROTECTION FOR TRANSMITTING AND RECEIVING SYSTEMS

AERIAL SYSTEM PROTECTION THROUGH LAMBDA/4 STUBLINE

Applications for different installation types:

- GSM and UMTS installations
- Tri-band systems
- Terrestrial trunked radio (TETRA)

Versions for N and DIN
7/16 connectors

High damping values

Bandpass filter, adjusted
to the application





SURGE PROTECTION FOR COAXIAL INTERFACES

Versions for different interfaces:

- BNC connectors
- FME connectors
- SMA connectors
- N connectors
- DIN 7/16 connectors

Protection
for different
voltage levels

Versions up to 6 GHz
available

Mounting on mounting
plate or as adapter plug/
socket





BNC connector

DataPro Koax-8V-BNC

Lightning and surge protection for coaxial signal lines with BNC connector for the use at the building entry.

- High performance surge protector
- Applicable at the building entry at the boundaries LPZ 0A-1 and higher
- For video surveillance cameras
- Connector according to IEC 61169-8
- Grounding via connected earthing wire 0.75 mm², L=ca.30 mm
- Test standard: IEC 61643-21 / EN 61643-21

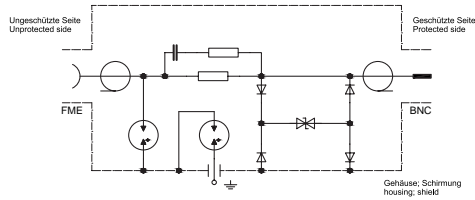

Basic circuit diagram

DataPro Koax BNC

Surge protection device for coaxial signal lines with BNC connectors and very high frequencies. The discharge current arrester can be mounted in and earthed in a mounting plate.

- Surge protection device for extremely high frequencies up to 6 GHz
- Applicable at the boundaries LPZ 0B - 1 and higher
- Connector according to IEC 61169-8
- Earthing via metal housing
- Test standard: IEC 61643-21 / EN 61643-21

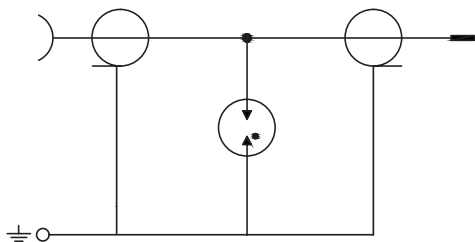

Basic circuit diagram



Technical Data	DataPro Koax-8V-BNC	DataPro Koax-8V-BNC-75 Ohm
Article-No.	54 43 46	54 43 40
IEC category/EN type	D1 / C2 / C1 / C3	D1 / C2 / C1 / C3
Plug connector	BNC (m/f)	BNC (m/f)
Max. continuous operating voltage DC	Uc 8 V=	8 V=
Max. power	0,7 W	0,7 W
Longitudinal impedance per wire	Z 10 Ω	10 Ω
Surge impedance	Z 50 Ω	75 Ω
Response time fine protection	tA ≤ 2 ns	≤ 2 ns
C2 nominal discharge current (8/20)	In 5 kA	5 kA
Max. impulse discharge current (8/20)	Imax 10 kA	10 kA
D1 lightning impulse current (10/350)	Iimp 1 kA	1 kA
C2 protection level line-shield at In	Up ≤ 20 V	≤ 20 V
C3 protection level line-shield at 1kV/μs	Up ≤ 13 V	≤ 13 V
C3 protection level line-shield-PE at 1kV/μs	Up ≤ 600 V	≤ 600 V
Frequency range	f0 0 - 60 MHz	0 - 60 MHz
Return loss	bei 40 kHz: > 20 dB	bei 40 kHz: > 20 dB
Operating temperature range	TU -25 - +85 °C	-25 - +85 °C
Degree of protection (IEC EN 60529)	IP 20	IP 20



Technical Data	DP Koax BNC 50 Ohm
Article-No.	54 43 30
IEC category/EN type	C2 / C1 / C3
Plug connector	BNC (m/f)
Surge impedance	Z 50 Ω
Frequency range	f0 0 - 6000 MHz
Return loss	≥ 20 dB
Breakdown voltage (100V/s)	150 - 250 V
C2 nominal discharge current (8/20 μs)	In 5 kA
Max. impulse discharge current (8/20)	Imax 10 kA
Max. transmission capacity	25 W
Operating temperature range	TU -40 - +85 °C
Degree of protection (IEC EN 60529)	IP 67

Dimension drawing, see pages 194 to 198

SMA connector

AntPro 5,8GHz-SMA

For coaxial signal lines with SMA connectors. Because of the high frequency range up to 6 GHz the device is to be applied also by WLAN and similar application.

- Surge protection device for extremely high frequencies up to 6 GHz
- Applicable at the boundaries LPZ 0B - 1 and higher
- Connector according to IEC 61169-8
- Earthing via metal housing
- Test standard: IEC 61643-21 / EN 61643-21
- Mounting with angle bracket or in mounting plate possible
- Second version with inverse polarity (inner conductor is socket instead of plug)

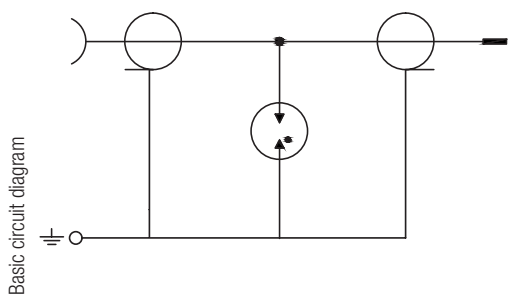

Technical Data	AntPro 5,8GHz-SMA	AntPro 5,8GHz-R-SMA
Article-No.	04 58 00	04 58 02
IEC category/EN type	C2 / C1 / C3	C2 / C1 / C3
Plug connector	SMA (m/f)	R-SMA (f/m)
Surge impedance	Z 50 Ω	50 Ω
Frequency range	f0 0 - 6000 MHz	0 - 6000 MHz
Return loss	≥ 20 dB	≥ 20 dB
Breakdown voltage (100V/s)	150 - 250 V	150 - 250 V
C2 nominal discharge current (8/20) In	5 kA	5 kA
Max. impulse discharge current (8/20)	10 kA	10 kA
Max. transmission capacity	25 W	25 W
Operating temperature range	TU -40 - +85 °C	-40 - +85 °C



FME connector

DataPro FME-AD

Surge voltage protection for sensitive GSM modems with FME antenna connector. The set contains an discharge current arrester with SMA connector and a frequency range up to 6 GHz and adapters for FME connectors.

- Surge protection device for extremely high frequencies up to 6 GHz
- Applicable at the boundaries LPZ 0B - 1 and higher
- Test standard: IEC 61643-21 / EN 61643-21
- Second version with inverse polarity (inner conductor is socket instead of plug)

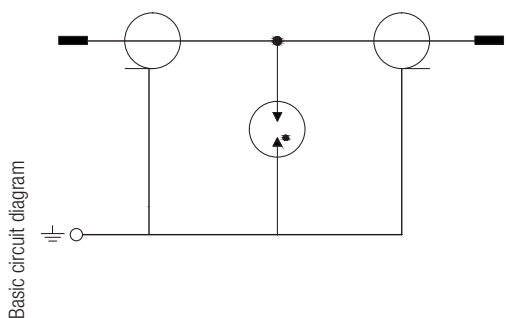

Technical Data	DP FME-AD
Article-No.	16 05 20
IEC category/EN type	C2 / C1 / C3
Plug connector	FME (m/m)
Surge impedance	Z 50 Ω
Frequency range	f0 0 - 6000 MHz
Return loss	≥ 20 dB
Breakdown voltage (100V/s)	150 - 250 V
C2 nominal discharge current (8/20 μs) In	5 kA
Max. impulse discharge current (8/20) Imax	10 kA
Max. transmission capacity	25 W
Operating temperature range	TU -40 - +80 °C



Dimension drawing, see pages 194 to 198





AntPro Lambda/4 N

Surge protective device in maintenance-free Lambda/4 style with band-pass filter characteristic. Therefore a very good transmission characteristic combined with high attenuation of the disturbances can be reached. Remote antenna power supply is not possible because of the short-circuit characteristic for low-frequency signals.

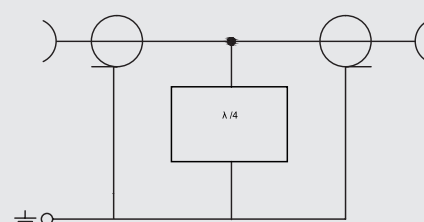
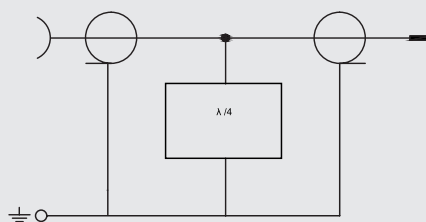
- High performance Lambda/4 Stubline for antenna protection without interruption of the useful signal
- Suitable for TETRA and GSM installations
- Applicable at the building entry at the boudaries LPZ 0A-1 and higher
- Connector according to IEC 61169-16
- Test standard: IEC 61643-21 / EN 61643-21



Basic circuit diagram

		without fig.	without fig.		without fig.
Technical Data	AntPro Lambda/4 N 0.51GHz	AntPro Lambda/4 N 0.8GHz	AntPro Lambda/4 N 2.0GHz	AntPro Lambda/4 N 0.51GHz (f/f)	AntPro Lambda/4 N 2.0GHz (f/f)
Article-No.	04 00 20	04 00 22	04 00 23	04 00 21	04 00 24
IEC category/EN type	D1 / C2 / C1 / C3	D1 / C2 / C1 / C3	D1 / C2 / C1 / C3	D1 / C2 / C1 / C3	D1 / C2 / C1 / C3
Plug connector	N (m/f)	N (m/f)	N (m/f)	N (f/f)	N (f/f)
Surge impedance Z	50 Ω	50 Ω	50 Ω	50 Ω	50 Ω
Frequency range f ₀	380 - 512 MHz	800 - 900 MHz	1700 - 2300 MHz	380 - 512 MHz	1700 - 2300 MHz
Return loss	< - 23 dB	< - 23 dB	< - 20,5 dB	< - 23 dB	< - 20,5 dB
Insertion loss	< 0,1 dB	< 0,1 dB	< 0,1 dB	< 0,1 dB	< 0,1 dB
Max. impulse discharge current (8/20) I _{max}	min. 50 kA	min. 50 kA	min. 50 kA	min. 50 kA	min. 50 kA
Vertical resistance inner conductor R	≤ 1,5 mΩ	≤ 1,5 mΩ	≤ 1,5 mΩ	≤ 1,5 mΩ	≤ 1,5 mΩ
Vertical resistance outer conductor R	≤ 1 mΩ	≤ 1 mΩ	≤ 1 mΩ	≤ 1 mΩ	≤ 1 mΩ
Operating temperature range TU	-30 - +100 °C	-30 - +100 °C	-30 - +100 °C	-30 - +100 °C	-30 - +100 °C
Degree of protection (IEC EN 60529)	IP 67	IP 67	IP 67	IP 67	IP 67

Dimension drawing, see pages 194 to 198



AntPro Lambda/4 7/16 TRI

Surge protective device in maintenance-free Lambda/4 style with band-pass filter characteristic. Therefore a very good transmission characteristic combined with high attenuation of the disturbances can be reached. Remote antenna power supply is not possible because of the short-circuit characteristic for low-frequency signals.

- High performance Lambda/4 Stubline for antenna protection without interruption of the useful signal
- Suitable for 800/900 MHz and 1800/1900 MHz-GSM and UMTS systems
- Connector according to IEC 61169-4
- Applicable at the building entry at the boudaries LPZ OA-1 and higher
- Test standard: IEC 61643-21 / EN 61643-21

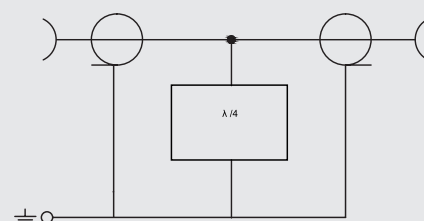
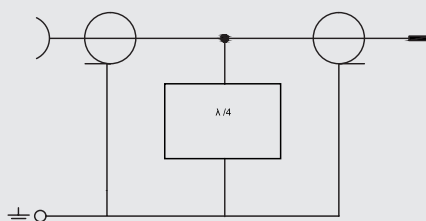

Basic circuit diagram

		without fig.	
Technical Data	AntPro Lambda/4 7/16 TRI	AntPro Lambda/4 7/16 TRI (f/f)	AntPro Lambda 7/16 0.42GHz
Article-No.	04 00 30	04 00 31	04 04 25
IEC category/EN type	D1 / C2 / C1 / C3	D1 / C2 / C1 / C3	D1 / C2 / C1 / C3
Plug connector	DIN 7/16 (m/f)	DIN 7/16 (f/f)	DIN 7/16 (f/f)
Surge impedance	Z 50 Ω	50 Ω	50 Ω
Frequency range	f0 806 - 960 / 1710 - 2200 MHz	806 - 960 / 1710 - 2200 MHz	380 - 512 MHz
Return loss	typ.: <-23dB / 806-859 MHz; <-27dB / 860-960 MHz; <-27dB / 1710-1990 MHz; <-23 dB / 2000-2200 MHz		< -23 dB
Insertion loss	< 0,1 dB	< 0,1 dB	< 0,1 dB
Max. impulse discharge current (8/20)	I _{max} min. 50 kA	min. 50 kA	min. 50 kA
Max. transmission capacity	W ≤ 1,8 kW / 1 GHz	W ≤ 1,8 kW / 1 GHz	5000 W
Vertical resistance inner conductor	R ≤ 0,4 mΩ	≤ 0,4 mΩ	≤ 0,4 mΩ
Vertical resistance outer conductor	R ≤ 0,2 mΩ	≤ 0,2 mΩ	≤ 0,2 mΩ
Operating temperature range	TU -55 - +150 °C	-55 - +150 °C	-55 - +150 °C
Degree of protection (IEC EN 60529)	IP 67	IP 67	IP 67

Dimension drawing, see pages 194 to 198



DataPro Koax 7/16

DataPro Koax 7/16 was developed for the coarse protection of highly sensitive RF amplifiers with DIN 7/16 connectors such as amplifiers for GSM antenna systems.

- High performance surge arrester for broad-band applications with frequency ranges from DC up to 2.5 GHz
- Applicable at the boundaries LPZ 0B - 1 and higher
- Connector according to IEC 61169-4
- Test standard: IEC 61643-21 / EN 61643-21
- Mounting with angle bracket or in mounting plate possible

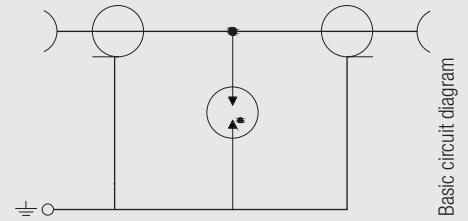
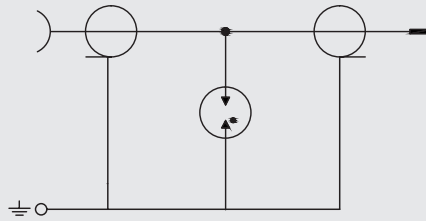

Basic circuit diagram

		
Technical Data	DP Koax 7/16	DP Koax 7/16 (f/f)
Article-No.	10 10 00	10 10 01
IEC category/EN type	C2 / C1 / C3	C2 / C1 / C3
Plug connector	DIN 7/16 (m/f)	DIN 7/16 (f/f)
Surge impedance	Z 50 Ω	50 Ω
Frequency range	f0 0 - 2500 MHz	0 - 2500 MHz
Return loss	typ.: 1GHz - 32dB; 2GHz - 23dB; 2,2GHz - 23dB; 2,5GHz - 20dB; 2,7GHz - 17 dB	
Insertion loss	typ.: 2,2GHz <0,1dB; 2,5GHz <0,2 dB	
DC spark-over voltage	230 V	230 V
C2 nominal discharge current (8/20 μs)	I _n 15 kA	15 kA
Max. impulse discharge current (8/20)	I _{max} 20 kA	20 kA
Insulation resistance	R _{isol} ≥ 10 GΩ	≥ 10 GΩ
Vertical resistance inner conductor	R ≤ 0,4 mΩ	≤ 0,4 mΩ
Vertical resistance outer conductor	R ≤ 0,2 mΩ	≤ 0,2 mΩ
Operating temperature range	TU -55 - +155 °C	-55 - +155 °C
Degree of protection (IEC EN 60529)	IP 67	IP 67

Dimension drawing, see pages 194 to 198





AntPro Koax-GSM-N/230

AntPro Koax-GSM-N was designed for the coarse protection of highly sensitive electronic HF amplifiers, e.g., for GSM aerial systems with GSM aerial cable RG213/U (max. 180 W at max. 1 GHz, Ø 10.5 mm).

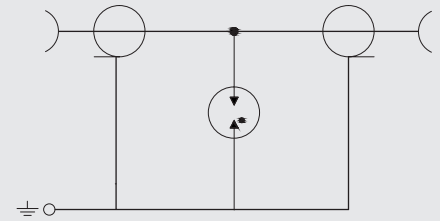
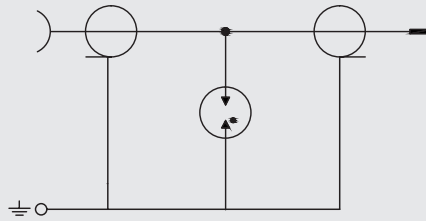
- High performance surge arrester for broadband applications with frequency ranges from DC up to 2.5 GHz.
- Applicable at the boundaries LPZ OB - 1 and higher
- Connector according to IEC 61169-8
- Test standard: IEC 61643-21 / EN 61643-21
- The f/f version can be mounted in a mounting plate or with an angle bracket.



Basic circuit diagram

		
Technical Data	AntPro Koax-GSM-N/230	AntPro Koax-GSM-N-230(f/f)
Article-No.	04 00 01	04 00 04
IEC category/EN type	C2 / C1 / C3	C2 / C1 / C3
Plug connector	N (m/f)	N (f/f)
Surge impedance	Z 50 Ω	50 Ω
Frequency range	f0 0 - 2500 MHz	0 - 2500 MHz
Return loss	dBtyp.: 1GHz: 30 dB/2,5 GHz: 23	
Insertion loss	dBtyp.: 1GHz<0,1dB/2,5 GHz<0,2	
DC spark-over voltage	230 V	230 V
C2 nominal discharge current (8/20 μs)	I _n 15 kA	15 kA
Max. impulse discharge current (8/20)	I _{max} 20 kA	20 kA
Insulation resistance	R _{isol} ≥ 5 GΩ	≥ 5 GΩ
Vertical resistance inner conductor	R ≤ 2 mΩ	≤ 2 mΩ
Vertical resistance outer conductor	R ≤ 0,5 mΩ	≤ 0,5 mΩ
Operating temperature range	TU -30 - +100 °C	-30 - +100 °C
Degree of protection (IEC EN 60529)	IP 67	IP 67

Accessories	
Product	MW-AntPro
Article-No.	17 01 66



Assembly bracket for AntPro devices

Dimension drawing, see pages 194 to 198





AntPro 6GHz-N

The devices are medium sized, precision, weatherproof connectors supplied with a screw coupling. Special design techniques for this series of connectors have resulted in excellent levels of performance with regard to return loss (VSWR) and intermodulation distortion.

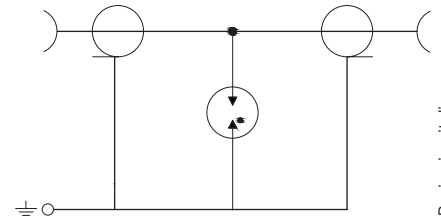
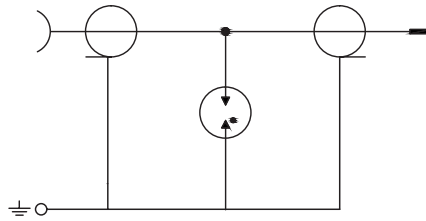
- N surge suppressor with gas discharge arrester
- Recommended coupling torque: 4-6 Nm



Basic circuit diagram

		
Technical Data	AntPro 6GHz-N(m/f)	AntPro 6GHz-N(f/f)
Article-No.	04 00 10	04 00 11
IEC category/EN type	C2 / C1 / C3	C2 / C1 / C3
Plug connector	N (m/f)	N (f/f)
Surge impedance	Z 50 Ω	50 Ω
Frequency range	f0 0 - 6000 MHz	0 - 6000 MHz
Return loss	≥ -20 dB	≥ -20 dB
Insertion loss rate at 1 and 3GHz/6GHz	IL ≤ 0.1 / 0.2 dB	≤ 0.1 / 0.2 dB
Nominal DC sparkover voltage at 100V/s	UagN 150-250 V=	150-250 V=
C2 nominal discharge current (8/20 μs)	In 5/10 kA	5/10 kA
Protection level at 1kV/μs	Up ≤ 600 V	≤ 600 V
Insulation resistance	Risol ≥ 5 GΩ	≥ 5 GΩ
Vertical resistance inner conductor	R ≤ 1.5 mΩ	≤ 1.5 mΩ
Vertical resistance outer conductor	R ≤ 1.0 mΩ	≤ 1.0 mΩ
Operating temperature range	TU -40 - +85 °C	-40 - +85 °C
Voltage resistance at 50 Hz	Umax 2.5 kVeff	2.5 kVeff
Response time at 1kV/μs	tA < 50 ns	< 50 ns
Max. aerial capacity (permanent HF capacity at VSWR = 1.1) Pmax	25 W	25 W
Capacitance, typ. asym. inner-conductor/earth	C ≤ 1.5 pF	≤ 1.5 pF
Degree of protection (IEC EN 60529)	IP 67	IP 67

Accessories	
Product	MW-AntPro
Article-No.	17 01 66



Assembly bracket for AntPro devices

Dimension drawing, see pages 194 to 198

TV/Radio connector

DataPro-SAT and Radio/TV

Surge protection device for radio and television equipment for the use directly at the building entry.

- High performance antenna protection
- Applicable at the building entry at the boundaries LPZ 0A-1 and higher
- Equipped with GDT surge voltage protector
- Easy installation
- Test standard: IEC 61643-21 / EN 61643-21
- F connector (acc. to IEC 60169-24)

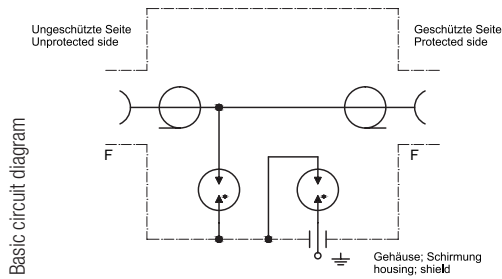

Technical Data	DataPro-SAT	DataPro-Radio/TV
Article-No.	21 00 20	21 00 30
IEC category/EN type	D1 / C2 / C1 / C3	D1 / C2 / C1 / C3
Plug connector	F connector	TV/Radio connector (acc. to IEC 60169-2)
Max. permissible rated direct voltage	Uc 75 V	75 V
Nominal current	IN 4 A	4 A
D1 lightning impulse current (10/350)	Iimp 2,5 kA	2,5 kA
C2 nominal discharge current (8/20 μs)	In 10 kA	10 kA
Protection level at 1kV/μs	Up 600 V	600 V
Impedance	Z 75 Ω	75 Ω
Insertion loss	fE 4 dB	4 dB
Frequency range	f0 0 - 2.150 MHz	0 - 862 MHz
Response time	tA ≤ 100 ns	≤100 ns
Operating temperature range	TU -40 - +80 °C	-40 - +80 °C
Degree of protection (IEC EN 60529)	IP 20	IP 20
Installation dimensions (W × H × D)	40 x 44 x 22 mm	40 x 44 x 42 mm
Mounting type	wall mounting	wall mounting

FILTER WITH INTEGRATED SURGE PROTECTION

For protection against overvoltages and harmonics Leutron offers EMC filters which are combined with a surge protection. These devices suppress harmonics and transient surges, hence, allowing equipment to operate smoothly even in high-interference environments. With the enhancement of its product range Leutron now offers protective devices for the area of measuring systems and automatic control, thus covering the complete field of industrial applications.

Leutron guarantees reliable signals due to EMC filters.

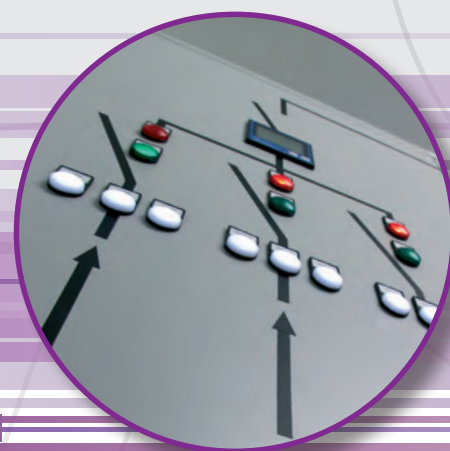
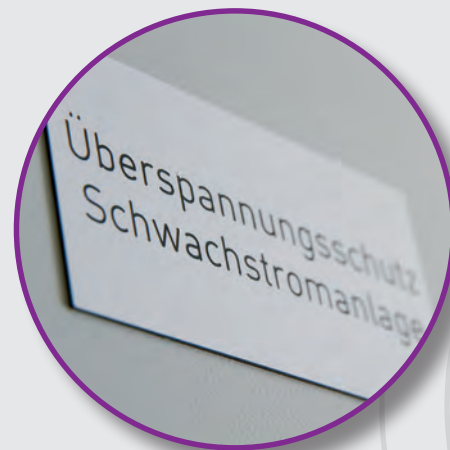

EMC FILTERS COMBINED WITH HARMONIZED SURGE PROTECTION:

- Protection against transient overvoltages and harmonics
- Leakage-current free
- Low residual voltages mean reduced stress for the system to be protected
- Outstanding differential-mode and common-mode damping of the filters

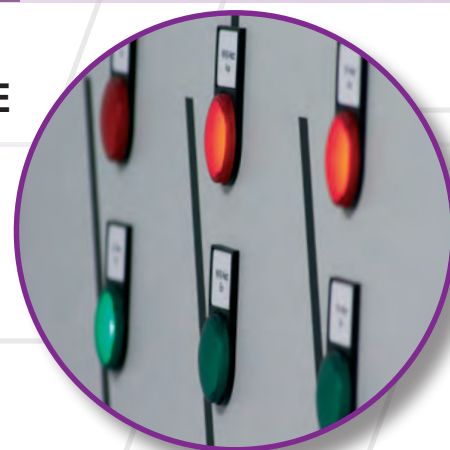



The EMC filters convince with their compact construction and the optimally harmonised protection components filter and surge protection.

EMC FILTERS WITH INTEGRATED SURGE PROTECTION

FILTERS WITH INTEGRATED SURGE PROTECTION UP TO 200 A

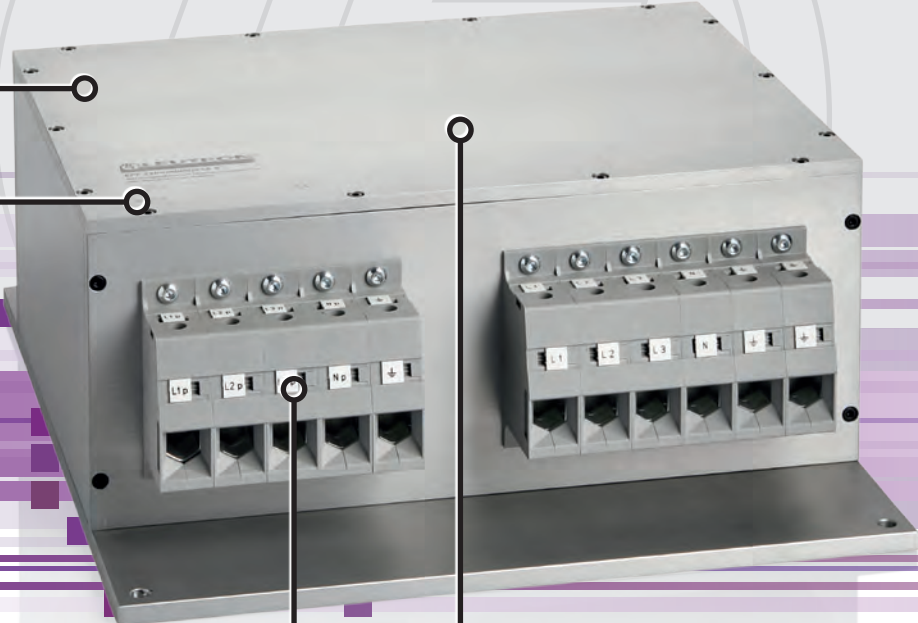

Robust and shielded design

Versions up to a nominal current of 200 A available

For one phase and three phase mains supplies

Harmonics filter, combined with surge protection



FILTERS WITH INTEGRATED SURGE PROTECTION FOR MEASURING AND CONTROL EQUIPMENT

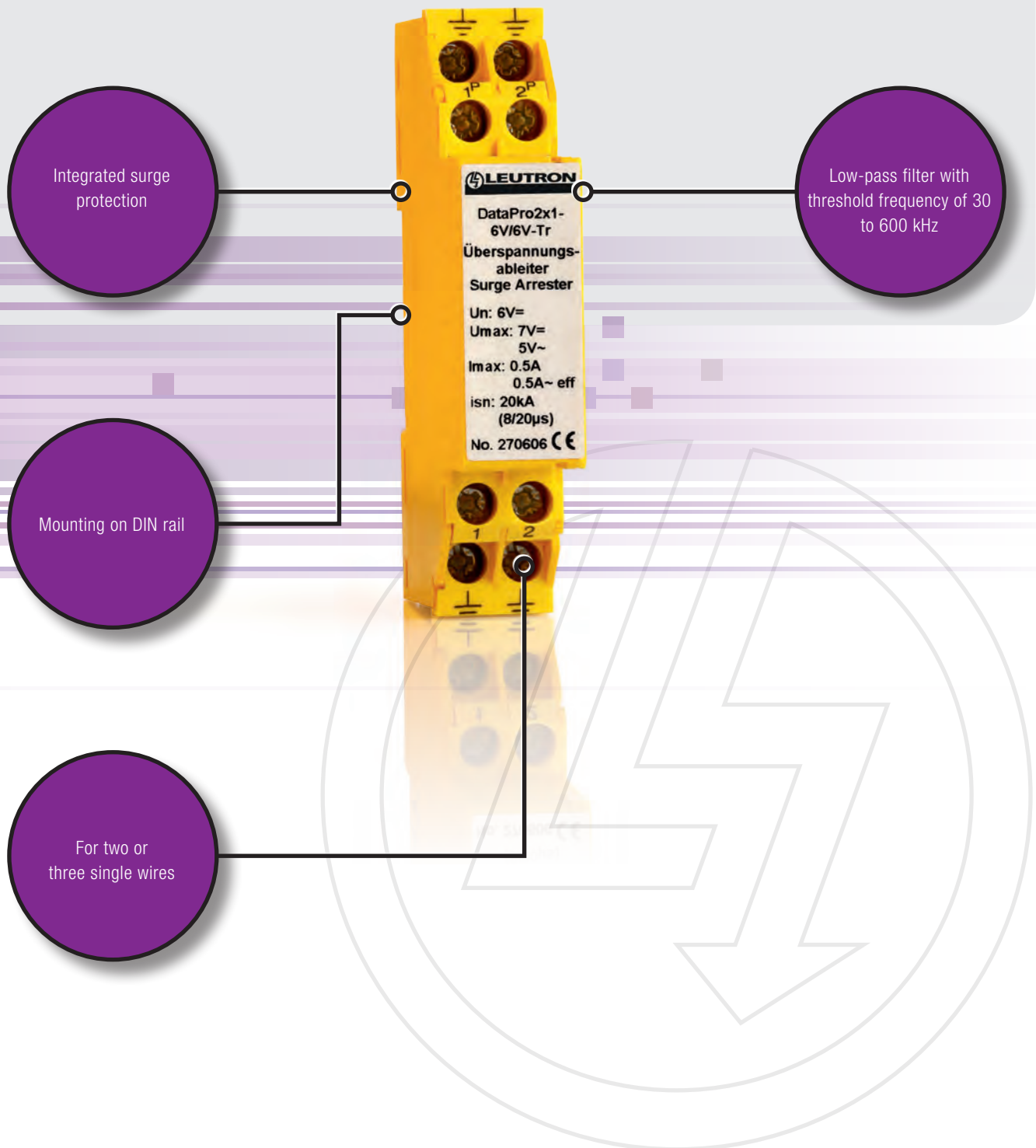



EMC FILTER WITH INTEGRATED SURGE PROTECTION LINE FILTER UP TO 200A

EnerPro Filter for mounting rail

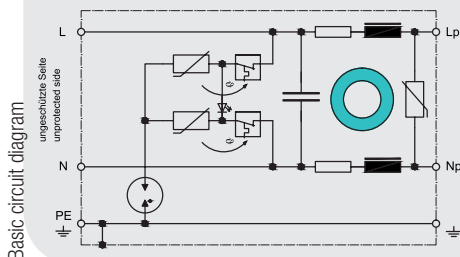

For overvoltage protection at single-pole TN systems with very sensitive electronic devices.



- Applicable at the boundaries LPZ OB - 2 and higher
- All leakage current-affected elements are galvanically isolated from earth by a gas-filled surge arrester (GDT).



- The protective circuit with filter contains an optimal decoupling between its medium protection (varistors) and its fine protection (varistors).
- Test standard: IEC 61643-1 / EN 61643-11

		
Technical Data	EPF 230V/16A-Tr	EPF 230V/25A-Tr
Article-No.	25 30 16	25 30 17
IEC category/EN type	Type 2 + 3 / class II + III	Type 2 + 3 / class II + III
Nominal alternating voltage	UN 230 V~	230 V~
Max. continuous operating voltage AC	Uc 275 V~	275 V~
Protection level at 5 kA (8/20 μs)	Up ≤ 1,4 kV	≤ 1,4 kV
Protection level at In (8/20)	Up ≤ 2 kV	≤ 2 kV
Response time L-N/L,N-PE	≤ 25 ns	≤ 25 ns
Nominal impulse discharge current (10 x 8/20)	In 15 kA	15 kA
Max. impulse discharge current (1x 8/20)	Imax 25 kA	25 kA
Max. acceptable fuse or back-up fuse	16 A gL/gG	25 A gL/gG
Operating temperature range	TU -40 - +80 °C	-40 - +80 °C
Max. conductor cross section	50mm ² stranded/35mm ² flexible	50mm ² stranded/35mm ² flexible
Recommended conductor cross section	25 mm ²	25 mm ²
Max. connection torque for terminals	4,5 Nm	4,5 Nm
Enclosure material / colour	Polycarbonate UL 94-V0 / yellow/grey	Polycarbonate UL 94-V0 / yellow/grey
Degree of protection (IEC EN 60529)	IP 20	IP 20
Mounting on	DIN rail 35 mm (DIN EN 50 022)	DIN rail 35 mm (DIN EN 50 022)
Installation dimensions (W × H × D)	88 x 107 x 67 mm	88 x 107 x 67 mm

Dimension drawing, see pages 194 to 198



EnerPro Filter up to 35 A, two-pole

For overvoltage protection at single-pole TN systems with very sensitive electronic devices.

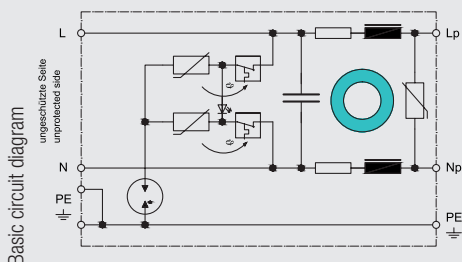

- Applicable at the boundaries LPZ 0B - 2 and higher
- The low-pass filter eliminates high-frequency electromagnetic interferences caused by lightning or switching actions in the network.
- Test standard: IEC 61643-1 / EN 61643-11
- Maximum impulse discharge current of 20 kA (8/20 μ s)
- To mount on a mounting plate.

					
Technical Data	EPF 60V/16A-S	EPF 48V/25A-S	EPF 230V/16A-S	EPF 230V/35A-S	EPF 230V/16A-W
Article-No.	25 30 22	25 30 53	25 30 20	25 30 85	25 30 25
IEC category/EN type	Type 2 + 3 / class II + III	Type 2 + 3 / class II + III	Type 2 + 3 / class II + III	Type 2 + 3 / class II + III	Type 2 + 3 / class II + III
Nominal voltage DC	UN 60 V=	48 V=	–	–	–
Max. continuous operating voltage DC	Uc 70 V=	70 V=	–	–	–
Nominal alternating voltage	UN 42 V~	42 V~	230 V~	230 V~	230 / 400 V~
Max. continuous operating voltage AC	Uc 50 V~	50 V~	275 V~	275 V~	275 / 480 V~
Protection level (1kV/ μ s)	Up $\leq 1,5$ kV	$\leq 1,0$ kV	$\leq 1,4$ kV	$\leq 1,4$ kV	$\leq 1,4$ kV
Protection level at In (8/20 μ s); worst case	Up $\leq 2,5$ kV	$\leq 1,5$ kV	≤ 2 kV	≤ 2 kV	≤ 2 kV
Response time L-N/L,N-PE	≤ 25 ns	≤ 25 ns	≤ 25 ns	≤ 25 ns	≤ 25 ns
Nominal discharge current (8/20)	In 15 kA	15 kA	15 kA	15 kA	15 kA
Max. impulse discharge current (8/20)	Imax 20 kA	20 kA	20 kA	20 kA	20 kA
Max. acceptable fuse or back-up fuse	16 A gL/gG	25 A gL/gG	16 A gL/gG	35 A gL/gG	16 A gL/gG
Operating temperature range	TU -40 - +80 °C	-40 - +80 °C	-40 - +80 °C	-40 - +80 °C	-40 - +80 °C
Max. conductor cross section	4 mm ²	4 mm ²	single wire 10mm ² / flexible 6 mm ²		
Recommended conductor cross section	2,5 mm ²	2,5 mm ²	2,5 mm ²	2,5 mm ²	2,5 mm ²
Enclosure material / colour	Aluminium/silver	Aluminium/silver	Aluminium/silver	Aluminium/silver	Aluminium/silver
Installation dimensions (W x H x D)	211 x 71 x 106 mm	211 x 71 x 106 mm	211 x 71 x 106 mm	211 x 71 x 106 mm	211 x 71 x 106 mm
Degree of protection (IEC EN 60529)	IP 20	IP 20	IP 20	IP 20	IP 20

Dimension drawing, see pages 194 to 198



EMC FILTER WITH INTEGRATED SURGE PROTECTION LINE FILTER UP TO 200A

EnerPro Filter up to 35 A, four-pole

EMC filter for data and signal lines combined with surge protection enables smooth operation of sensitive electronic equipment in rough environment. Suitable for the application in three-phase 230/400V TN systems.



Basic circuit diagram

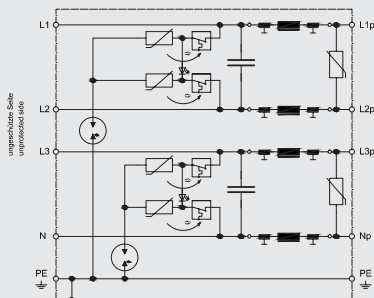

- Applicable at the boundaries LPZ 0B - 2 and higher
- Leakage current-free
- Test standard: IEC 61643-1 / EN 61643-11
- Protects foundation earthing electrode against AC-caused corrosion
- To protect the supply of sensible equipment and installations
- Max. impulse discharge current of 25 kA (8/20)

		without fig.	
Technical Data	EPF 230/400V/16A-W	EPF 230/400V/25A-W	EPF 230/400V/35A-W
Article-No.	25 30 45	25 30 80	25 31 00
IEC category/EN type	Type 2 + 3 / class II + III	Type 2 + 3 / class II + III	Type 2 + 3 / class II + III
Nominal alternating voltage	UN 230 / 400 V~	230 / 400 V~	230 / 400 V~
Max. continuous operating voltage AC	Uc 275 / 480 V~	480 V~	275 / 480 V~
Protection level at 5 kA (8/20) or 1kV/μs	Up ≤ 1,4 kV	≤ 1,4 kV	≤ 1,4 kV
Protection level at In (8/20); worst case	Up ≤ 2 kV	≤ 2 kV	≤ 2 kV
Response time L-N/L,N-PE	≤ 25/ ≤ 50 ns	≤ 25 ns	≤ 25 ns
Response time	tA < 25 ns	< 25 ns	< 25 ns
Nominal discharge current (8/20)	In 15 kA	15 kA	15 kA
Max. impulse discharge current (8/20)	Imax 20 kA	25 kA	20 kA
Max. acceptable back-up fuse or circuit-breaker (MCB)	16 A gL/gG	25 A gL/gG	35 gL / gG A
Operating temperature range	TU -40 - +80 °C	-40 - +80 °C	-40 - +80 °C
Max. conductor cross section	single wire 10mm ² / flexible 6 mm ²		
Installation dimensions (W × H × D)	209 x 106 x 71 mm	211 x 106 x 72 mm	209 x 106 x 71 mm
Enclosure material / colour	Aluminium/silver	Aluminium/silver	Aluminium/silver
Degree of protection (IEC EN 60529)	IP 20	IP 20	IP 20
Mounting on	mounting plate	Mounting plate	Mounting plate

Dimension drawing, see pages 194 to 198



EnerPro Filter up to 200 A, four-pole



EMC filter for data and signal lines combined with surge protection enables smooth operation of sensitive electronic equipment in rough environment. Suitable for the application in three-phase 230/400V TN systems.

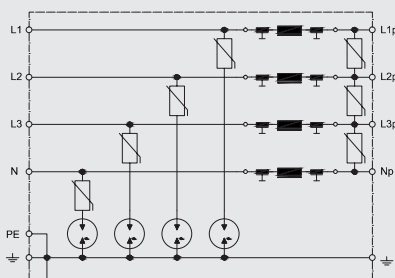

Basic circuit diagram



- Applicable at the boundaries LPZ 0B - 2 and higher
- 4-pole
- Leakage current-free
- Test standard: IEC 61643-1 / EN 61643-11
- Protects foundation earthing electrode against AC-caused corrosion
- To protect the supply of sensible equipment and installations

			
Technical Data	EPF 230/400V/63A-E	EPF 230/400V/100A-E	EPF 230/400V/200A-E
Article-No.	25 31 30	25 31 40	25 31 60
IEC category/EN type	Type 2 + 3 / class II + III	Type 2 + 3 / class II + III	Type 2 + 3 / class II + III
Nominal alternating voltage	UN 230 / 400 V~	230 / 400 V~	230 / 400 V~
Max. continuous operating voltage AC	Uc 275 / 480 V~	275 / 480 V~	275 / 480 V~
Protection level at 5kA (8/20) or 1kV/µs	Up ≤ 1,4 kV	≤ 1,4 kV	≤ 1,4 kV
Protection level at In (8/20); worst case	Up ≤ 2 kV	≤ 2 kV	≤ 2 kV
Response time L-N/L,N-PE	≤ 25 ns	≤ 25 ns	≤ 25 ns
Nominal discharge current (8/20)	In 15 kA	15 kA	15 kA
Max. impulse discharge current (8/20)	Imax 25 kA	25 kA	25 kA
Max. acceptable back-up fuse or circuit-breaker (MCB)	63 A gL/gG	100 A gL/gG	200 A gL/gG
Operating temperature range	TU -40 - +80 °C	-40 - +80 °C	-40 - +80 °C
Max. conductor cross section	solid 25-95/flexible. 35-95 mm ²	solid 25-95/flexible. 35-95 mm ²	solid 25-95/flexible. 35-95 mm ²
Max. connection torque for terminals	4,5 Nm	4,5 Nm	4,5 Nm
Installation dimensions (W × H × D)	240 x 106 x 110 mm	420 x 380 x 170 mm	420 x 380 x 170 mm
Enclosure material / colour	Aluminium/silver	Aluminium/silver	Aluminium/silver
Degree of protection (IEC EN 60529)	IP 20	IP 20	IP 20
Mounting on	Mounting plate	Mounting plate	Mounting plate

Dimension drawing, see pages 194 to 198



IsoProData 150V/150V-Tr

EMC filter for data and signal lines combined with surge protection enables smooth operation of sensitive electronic equipment in rough environment.

- Signal and data line protection with low-pass filter
- Protective circuit for 2 signal lines without reference to ground potential
- Lightning current 5 kA (10/350) per wire
- Applicable at the boundaries LPZ 0A - 2 and higher
- Mounting on 35 mm DIN rail (EN 60715)
- Degree of protection according to IEC EN 60529: IP 20
- Space required for installation: 17.5 mm

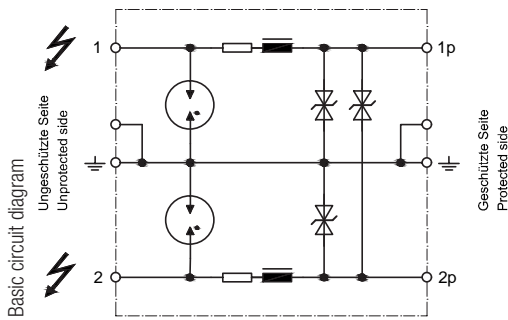

Technical Data		IsoProData 150V/150V-Tr
Article-No.		27 03 03
IEC category/EN type		C1 / C2 / C3 / D1
Nominal voltage DC	UN	150 V=
Max. continuous operating voltage DC	Uc	160 V=
Max. continuous operating voltage AC	Uc	112 V~
Nominal current	IN	1,5 A
Leakage current at Uc DC	IL	≤ 5 µA
Longitudinal impedance (DC resistance) per wire	Z	0,3 Ω
Series inductance, typ.		130 µH
Response time	tA	≤ 2 ns
C2 Nominal discharge current (8/20)	In	20 kA
D1 lightning impulse current (10/350 µs)	Itotal	10 kA
D1 lightning impulse current (10/350) per line	Iimp	5 kA
Protection level, residual voltage line-ground at In resp. 1 kV/µs	Up	≤ 250 V
Capacitance, line-earth	C	< 1 nF
Max. operating frequency (-3 dB)	fG	600 kHz
Operating temperature range	TU	-25 - +85 °C
Max. conductor cross section		16 mm ² massiv or 6 mm ² flexible with sleeve

Dimension drawing, see pages 194 to 198



DataPro2x1 for DIN rail mounting

EMC filter for data and signal lines combined with surge protection enables smooth operation of sensitive electronic equipment in rough environment.

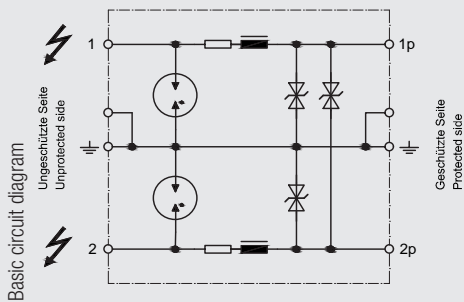

- Signal and data line protection with low-pass filter
- Protective circuit for 2 signal lines with common ground
- Max. operating current 500 mA
- Applicable at the boundaries LPZ 0B - 2 and

higher

- Mounting on 35 mm DIN rail (EN 60715)
- Degree of protection according to IEC EN 60529: IP 20
- Space required for installation: 17.5 mm

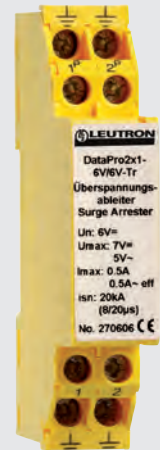

				
Technical Data	DP2x1-6V/6V-Tr	DP2x1-12V/12V-Tr	DP2x1-15V/15V-Tr	DP2x1-24V/24V-Tr
Article-No.	27 06 06	27 12 12	27 15 15	27 24 24
IEC category/EN type	C1 / C2 / C3	C1 / C2 / C3	C1 / C2 / C3	C1 / C2 / C3
Nominal voltage DC	UN 6 V=	12 V=	15 V=	24 V=
Max. continuous operating voltage DC	Uc 7 V=	13,6 V=	17 V=	28 V=
Max. continuous operating voltage AC	Uc 5 V~	10 V~	12 V~	20 V~
Nominal current	IN 0,5 A	0,5 A	0,5 A	0,5 A
C2 Nominal discharge current (8/20)	Imax 20 kA	20 kA	20 kA	20 kA
C2 Nominal discharge current (8/20) per line	In 10 kA	10 kA	10 kA	10 kA
Protection level at In (line-earth)	Up ≤ 9 V	≤ 18 V	≤ 23 V	≤ 36 V
Leakage current at Umax	IL ≤ 5 µA	≤ 5 µA	≤ 5 µA	≤ 5 µA
Max. operating frequency (-3 dB)	fG 600 kHz	600 kHz	600 kHz	600 kHz
DC resistance	R 4,6 Ω	4,6 Ω	4,6 Ω	4,6 Ω
Series inductance, typ.	L 28 µH	28 µH	28 µH	28 µH
Response time	tA ≤ 2 ns	≤ 2 ns	≤ 2 ns	≤ 2 ns
Capacitance, line-earth	C 4 nF	< 2,3 nF	≤ 1,5 nF	≤ 1,3 nF
Operating temperature range	TU -25 - +85 °C	-25 - +85 °C	-25 - +85 °C	-25 - +85 °C
Max. conductor cross section	2.5mm ² solid or 1.5mm ² flexible with sleeve	2.5mm ² solid or 1.5mm ² flexible with sleeve	2.5mm ² solid or 1.5mm ² flexible with sleeve	2.5mm ² solid or 1.5mm ² flexible with sleeve
Enclosure material / colour	Polycarbonate (halogen-free) UL 94-V0/yellow	Polycarbonate (halogen-free) UL 94-V0/yellow	Polycarbonate (halogen-free) UL 94-V0/yellow	Polycarbonate (halogen-free) UL 94-V0/yellow

Dimension drawing, see pages 194 to 198



EMC FILTER WITH INTEGRATED SURGE PROTECTION

MCR TECHNOLOGY WITH INTEGRATED LOW-PASS FILTER

				
Technical Data	DP2x1-30V/30V-Tr	DP2x1-36V/36V-Tr	DP2x1-48V/48V-Tr	DP2x1-60V/60V-Tr
Article-No.	27 30 30	27 36 36	27 48 48	27 60 60
IEC category/EN type	C1 / C2 / C3	C1 / C2 / C3	C1 / C2 / C3	C1 / C2 / C3
Nominal voltage DC	UN 30 V=	36 V=	48 V=	60 V=
Max. continuous operating voltage DC	Uc 33 V=	40 V=	53 V=	64 V=
Max. continuous operating voltage AC	Uc 22 V~	29 V~	37 V~	45 V~
Nominal current	IN 0,5 A	0,5 A	0,5 A	0,5 A
C2 Nominal discharge current (8/20)	Imax 20 kA	20 kA	20 kA	20 kA
C2 Nominal discharge current (8/20) per line	In 10 kA	10 kA	10 kA	10 kA
Protection level at In (line-earth)	Up ≤ 45 V	≤ 55 V	≤ 72 V	≤ 90 V
Leakage current at Umax	IL ≤ 5 µA	≤ 5 µA	≤ 5 µA	≤ 5 µA
Max. operating frequency (-3 dB)	fG 600 kHz	600 kHz	600 kHz	600 kHz
DC resistance	R 4,6 Ω	4,6 Ω	4,6 Ω	4,6 Ω
Series inductance, typ.	28 µH	28 µH	28 µH	28 µH
Response time	tA ≤ 2 ns	≤ 2 ns	≤ 2 ns	≤ 2 ns
Capacitance, line-earth	C ≤ 1 nF	≤ 1 nF	≤ 0,8 nF	≤ 0,7 nF
Operating temperature range	TU -25 - +85 °C	-25 - +85 °C	-25 - +85 °C	-25 - +85 °C
Max. conductor cross section	2.5mm ² solid or 1.5mm ² flexible with sleeve	2.5mm ² solid or 1.5mm ² flexible with sleeve	2.5mm ² solid or 1.5mm ² flexible with sleeve	2.5mm ² solid or 1.5mm ² flexible with sleeve
Enclosure material / colour	Polycarbonate (halogen-free) UL 94-V0/yellow	Polycarbonate (halogen-free) UL 94-V0/yellow	Polycarbonate (halogen-free) UL 94-V0/yellow	Polycarbonate (halogen-free) UL 94-V0/yellow

	without fig.	
Technical Data	DP2x1-80V/80V-Tr	DP2x1-150V/150V-Tr
Article-No.	27 80 80	27 04 04
IEC category/EN type	C1 / C2 / C3	C1 / C2 / C3
Nominal voltage DC	UN 80 V=	150 V=
Max. continuous operating voltage DC	Uc 85 V=	160 V=
Max. continuous operating voltage AC	Uc 60 V~	112 V~
Nominal current	IN 0,5 A	0,5 A
C2 Nominal discharge current (8/20)	Imax 20 kA	20 kA
C2 Nominal discharge current (8/20) per line	In 10 kA	10 kA
Protection level at In (line-earth)	Up ≤ 140 V	≤ 250 V
Leckstrom bei Uc DC	IL ≤ 5 µA	≤ 5 µA
Max. operating frequency (-3 dB)	fG 600 kHz	600 kHz
DC resistance	R 4,6 Ω	4,4 Ω
Series inductance, typ.	≤ 28 µH	28 µH
Capacitance, line-earth	C ≤ 1 nF	≤ 1 nF
Operating temperature range	TU -25 - +85 °C	-25 - +85 °C
Max. conductor cross section	2.5mm ² solid or 1.5mm ² flexible with sleeve	2.5mm ² solid or 1.5mm ² flexible with sleeve
Enclosure material / colour	Polycarbonate (halogen-free) UL 94-V0/yellow	Polycarbonate (halogen-free) UL 94-V0/yellow
Degree of protection (IEC EN 60529)	IP 20	IP 20

Dimension drawing, see pages 194 to 198



DataPro3x1 for DIN rail mounting

EMC filter for data and signal lines combined with surge protection enables smooth operation of sensitive electronic equipment in rough environment.



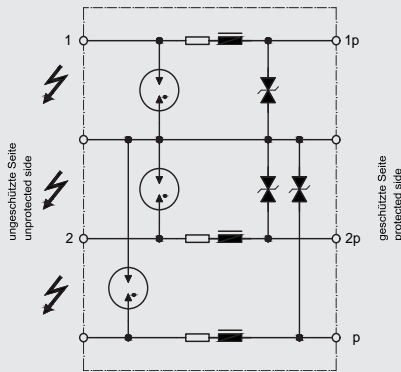

Basic circuit diagram



- Signal and data line protection with low-pass filter
- Protective circuit for 3 signal lines with common ground
- Applicable at the boundaries LPZ 0B - 2 and higher

- Mounting on 35 mm DIN rail (EN 60715)
- Degree of protection according to IEC EN 60529: IP 20
- Space required for installation: 17.5 mm
- Max. nominal current 500 mA



				
Technical Data	DP3x1-12V/12V-Tr	DP3x1-15V/15V-Tr	DP3x1-24V/24V-Tr	DP3x1-30V/30V-Tr
Article-No.	28 12 12	28 15 15	28 24 24	28 30 30
IEC category/EN type	C1 / C2 / C3	C1 / C2 / C3	C1 / C2 / C3	C1 / C2 / C3
Nominal voltage DC	UN 12 V=	15 V=	24 V=	30 V=
Max. continuous operating voltage DC	Uc 13,6 V=	17 V=	28 V=	33 V=
Max. continuous operating voltage AC	Uc 12 V~	12 V~	20 V~	22 V~
Nominal current	IN 0,5 A	0,5 A	0,5 A	0,5 A
C2 Nominal discharge current (8/20)	I _{max} 20 kA	20 kA	20 kA	20 kA
C2 Nominal discharge current (8/20) per line	I _n 10 kA	10 kA	10 kA	10 kA
Protection level at I _n (line-earth)	U _p ≤ 18 V	≤ 23 V	≤ 36 V	≤ 45 V
Leakage current at U _{max} DC	I _L ≤ 5 µA	≤ 5 µA	≤ 5 µA	≤ 5 µA
Max. operating frequency (-3 dB)	f _G 600 kHz	600 kHz	600 kHz	600 kHz
DC resistance	R 4.6 Ω	4.6 Ω	4.6 Ω	4.6 Ω
Series inductance, typ.	28 µH	28 µH	28 µH	28 µH
Capacitance, line-earth	C ≤ 2.3 nF	≤ 1,5 nF	≤ 1.3 nF	≤ 1 nF
Operating temperature range	TU -25 - +85 °C	-25 - +85 °C	-25 - +85 °C	-25 - +85 °C
Max. conductor cross section	2.5mm ² solid or 1.5mm ² flexible with sleeve	2.5mm ² solid or 1.5mm ² flexible with sleeve	2.5mm ² solid or 1.5mm ² flexible with sleeve	2.5mm ² solid or 1.5mm ² flexible with sleeve
Enclosure material / colour	Polycarbonate (halogen-free) UL 94-V0/yellow	Polycarbonate (halogen-free) UL 94-V0/yellow	Polycarbonate (halogen-free) UL 94-V0/yellow	Polycarbonate (halogen-free) UL 94-V0/yellow
Degree of protection (IEC EN 60529)	IP 20	IP 20	IP 20	IP 20

Dimension drawing, see pages 194 to 198



EMC FILTER WITH INTEGRATED SURGE PROTECTION

MCR TECHNOLOGY WITH INTEGRATED LOW-PASS FILTER

				
Technical Data	DP3x1-36V/36V-Tr	DP3x1-48V/48V-Tr	DP3x1-60V/60V-Tr	DP3x1-150V/150V-Tr
Article-No.	28 36 36	28 48 48	28 60 60	28 04 04
IEC category/EN type	C1 / C2 / C3	C1 / C2 / C3	C1 / C2 / C3	C1 / C2 / C3
Nominal voltage DC	UN 36 V=	48 V=	60 V=	150 V=
Max. continuous operating voltage DC	Uc 40 V=	53 V=	64 V=	160 V=
Max. continuous operating voltage AC	Uc 29 V~	37 V~	45 V~	112 V~
Nominal current	IN 0,5 A	0,5 A	0,5 A	0,5 A
C2 Nominal discharge current (8/20)	Imax 20 kA	20 kA	20 kA	20 kA
C2 Nominal discharge current (8/20) per line	In 10 kA	10 kA	10 kA	10 kA
Protection level at In (line-earth)	Up ≤ 55 V	≤ 72 V	≤ 90 V	≤ 250 V
Leakage current at Umax DC	IL ≤ 5 µA	≤ 5 µA	≤ 5 µA	≤ 5 µA
Max. operating frequency (-3 dB)	fG 600 kHz	600 kHz	600 kHz	600 kHz
DC resistance	R 4.6 Ω	4.6 Ω	4.6 Ω	4.4 Ω
Series inductance, typ.	28 µH	28 µH	28 µH	28 µH
Capacitance, line-earth	C ≤ 1 nF	≤ 0.8 nF	≤ 0.7 nF	≤ 1 nF
Operating temperature range	TU -25 - +85 °C	-25 - +85 °C	-25 - +85 °C	-25 - +85 °C
Conductor cross section	2.5mm ² solid or 1.5mm ² flexible with sleeve	2.5mm ² solid or 1.5mm ² flexible with sleeve	2.5mm ² solid or 1.5mm ² flexible with sleeve	2.5mm ² solid or 1.5mm ² flexible with sleeve
Enclosure material / colour	Polycarbonate (halogen-free) UL 94-V0/yellow	Polycarbonate (halogen-free) UL 94-V0/yellow	Polycarbonate (halogen-free) UL 94-V0/yellow	Polycarbonate (halogen-free) UL 94-V0/yellow
Degree of protection (IEC EN 60529)	IP 20	IP 20	IP 20	IP 20

Dimension drawing, see pages 194 to 198





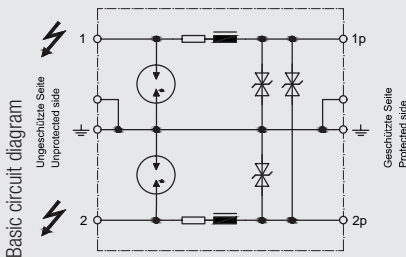
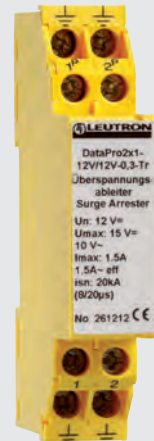

DataPro2x1 0,30hm-Tr

Lightning current and surge voltage protection for particularly long signal and bus lines. Thanks to the extremely low volume resistance (impedance only 0.3 Ω) no noteworthy signal losses occur. It is a combined arrester to protect two single wires. Applicable at the LPZ transition point OA-1 and higher.



- Signal and data line protection with low-pass filter
- Protective circuit for 2 signal lines with common ground
- Applicable at the boundaries LPZ OA - 2 and higher

- Mounting on 35 mm DIN rail (EN 60715)
- Degree of protection according to IEC EN 60529: IP 20
- Space required for installation: 17.5 mm
- Very low volume resistance

				
Technical Data	DP 2x1-12V/12V-0,3Ω -Tr	DP 2x1-24V/24V-0,3Ω -Tr	DP 2x1-30V/30V-0,3Ω -Tr	DP 2x1-36V/36V-0,3Ω -Tr
Article-No.	26 12 12	26 24 24	26 30 30	26 36 36
IEC category/EN type	C1 / C2 / C3 / D1	C1 / C2 / C3 / D1	C1 / C2 / C3 / D1	C1 / C2 / C3 / D1
Nominal voltage DC	UN 12 V=	24 V=	30 V=	36 V=
Max. continuous operating voltage DC	Uc 28 V=	33 V=	35 V=	40 V=
Max. continuous operating voltage AC	Uc 20 V~	22 V~	25 V~	29 V~
Nominal current	IL 1,5 A	1,5 A	1,5 A	1,5 A
Longitudinal impedance (DC resistance) per wire	Z 0,3 Ω	0,3 Ω	0,3 Ω	0,3 Ω
Series inductance, typ.	56 μH	56 μH	56 μH	56 μH
Response time fine protection	tA ≤ 2 ns	≤ 2 ns	≤ 2 ns	≤ 2 ns
C2 nominal discharge current (8/20 μs)	In 10 kA	10 kA	10 kA	10 kA
D1 lightning impulse current (10/350 μs)	Itotal 5 kA	5 kA	5 kA	5 kA
D1 lightning impulse current (10/350 μs) per line	Iimp 2,5 kA	2,5 kA	2,5 kA	2,5 kA
Protection level at In resp. 1 kV/μs (line-earth)	Up ≤ 18 V	≤ 36 V	≤ 42 V	≤ 55 V
Capacitance, line-earth	C ≤ 2,3 nF	≤ 1,3 nF	≤ 1,1 nF	≤ 1 nF
Max. operating frequency (-3 dB)	fG <600 kHz	< 600 kHz	< 600 kHz	<600 kHz
Insulation resistance	Risol >10 GΩ	> 10 GΩ	> 10 GΩ	>10 GΩ
Operating temperature range	TU -25 - +85 °C	-25 - +85 °C	-25 - +85 °C	-25 - +85 °C
Max. conductor cross section	2.5 mm ² single-wire / 1.5 mm ² flexible with sleeve	2.5 mm ² single-wire / 1.5 mm ² flexible with sleeve	2.5 mm ² single-wire / 1.5 mm ² flexible with sleeve	2.5 mm ² single-wire / 1.5 mm ² flexible with sleeve

Dimension drawing, see pages 194 to 198



DataPro2x1-RLC/50V-Tr

EMC filter for data and signal lines combined with surge protection enables smooth operation of sensitive electronic equipment in rough environment. Surge voltage protector for electrical equipment with an operating voltage of up to 50 V DC, with an impulse current withstand strength of 20 kA (8/20 μ s). The device was designed to protect sensitive electronic equipment.

- Signal and data line protection with low-pass filter
- Protective circuit for 2 signal lines without reference to ground potential
- Max. nominal current 100 mA
- Applicable at the boundaries LPZ 0B - 2 and higher
- Mounting on 35 mm DIN rail (EN 60715)

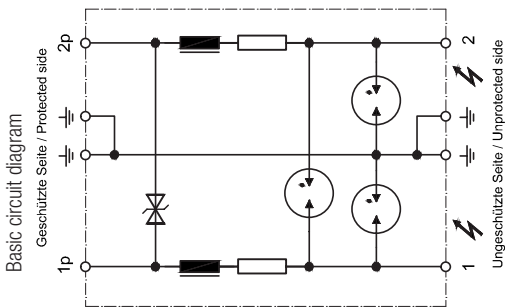

DataPro2x1-RLC-Tr

EMC filter for data and signal lines combined with surge protection enables smooth operation of sensitive electronic equipment in rough environment.

- Signal and data line protection with low-pass filter
- Operating voltage up to 150 V DC
- Protective circuit for 2 signal lines with common ground
- Mounting on 35 mm DIN rail (EN 60715)
- Degree of protection according to IEC EN 60529: IP 20

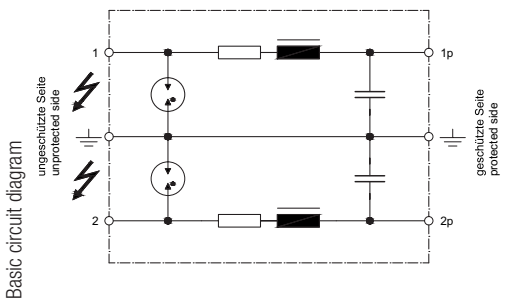

Technical Data	DP 2x1-RLC/50V-Tr
Article-No.	28 70 50
IEC category/EN type	C1 / C2 / C3
Max. continuous operating voltage DC	Uc 50 V=
Nominal current	IN 0,1 A
C2 Nominal discharge current (8/20)	Imax 20 kA
C2 Nominal discharge current (8/20) per line	In 10 kA
Protection level at 1kV/ μ s (1p-2p)	Up \leq 60 V
Protection level at 1kV/ μ s (1p,2p-PE)	Up \leq 650 V
Response time 1p-2p, 2-PE (at 1kV/ μ s)	tA \leq 2/25 ns
Operating temperature range	TU -25 +85 °C
Max. conductor cross section	2.5 mm ² solid or 1.5 mm ² flexible with sleeve
Enclosure material / colour	Polycarbonate (halogen-free), UL 94-V0 / yellow
Protection circuit casting compound	Polyurethan, flexible
Degree of protection (IEC EN 60529)	IP 20
Dimension (DIN 43880)	17.5 mm



Technical Data	DP 2x1-RLC-Tr
Article-No.	27 00 00
IEC category/EN type	C1 / C2 / C3
Nominal voltage DC	UN 150 V=
Max. continuous operating voltage DC	Uc 170 V=
Max. continuous operating voltage AC	Uc 120 V~
Nominal current	IN 0,5 A
C2 Nominal discharge current (8/20)	Imax 20 kA
C2 Nominal discharge current (8/20) per line	In 10 kA
Leakage current at Umax DC	IL \leq 0,001 μ A
Max. operating frequency (-3 dB)	fG 100 kHz
DC resistance	R 4,3 Ω
Series inductance, typ.	185 μ H
Capacitance, line-earth	C \leq 2,2 nF
Protection level line-earth at 1kV/ μ s and n	Up \leq 800 V
Operating temperature range	TU -25 - +85 °C
Max. conductor cross section	2.5 mm ² solid or 1.5 mm ² flexible with sleeve
Dimension (DIN 43880)	17.5 mm

Dimension drawing, see pages 194 to 198



DataPro2-2MB-Tr

EMC filter for data and signal lines combined with surge protection enables smooth operation of sensitive electronic equipment in rough environment.

- Signal and data line protection with low-pass filter
- Applicable for transmission rates of 2 MBit/s (ISDN, PCM)
- Max. nominal current 500 mA
- Applicable at the boundaries LPZ 0B - 2 and higher
- Mounting on 35 mm DIN rail (EN 60715)
- Space required for installation: 17.5 mm

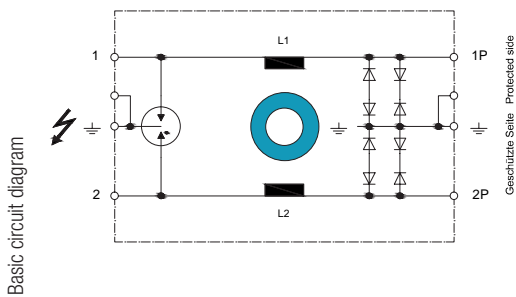

Technical Data	DP2-2MB-Tr
Article-No.	24 00 17
IEC category/EN type	C1 / C2 / C3
Nominal voltage DC	UN 150 V=
Max. continuous operating voltage DC	Uc 170 V=
Max. continuous operating voltage AC	Uc 120 V~
Nominal current	IL 0,5 A
C2 Nominal discharge current (8/20)	Imax 10 kA
C2 Nominal discharge current (8/20) per line	In 5 kA
Protection level line-earth at 1 kV/μs	Up ≤ 600 V
Max. operating frequency (-3 dB)	fG 8 MHz
Operating temperature range	TU -25 - +85 °C
DC resistance	R 0,5 Ω
Signal transmission rate	up to 2 Mbit/s
Conductor cross section	2.5 mm ² solid or 1.5 mm ² flexible with sleeve
Dimension (DIN 43880)	17.5 mm



DataPro2x8-36V/36V-Tr

Designed to protect sensitive input and output interfaces at electrical devices. Suitable, e.g., for fire alarm systems. Alternatively, GO or GU version to provide clear wiring (GO = protected side on top, GU = protected side at the bottom).

- High performance surge protector
- Dimension: 45 x 110 x 121 mm
- Merging of eight lines
- Two-stage low-pass filter

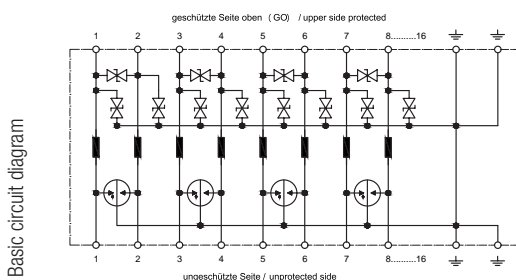

Technical Data	DP 2x8-36V/36V-Tr/GO	DP 2x8-36V/36V-Tr/GU
Article-No.	27 90 00	27 90 01
Nominal voltage DC	UN < 36 V=	< 36 V=
Max. continuous operating voltage DC	Uc 40 V=	40 V=
Max. continuous operating voltage AC	Uc 28 V~	28 V~
Nominal current	IL 1,5 A	1,5 A
C2 Nominal discharge current (8/20)	Imax 20 kA	20 kA
C2 Nominal discharge current (8/20) per line	In 2,5 kA	2,5 kA
Protection level at In (line-earth)	Up ≤ 75 V	≤ 75 V
Leakage current at Umax DC	IL 0,001 μA	0,001 μA
Max. operating frequency (-3 dB)	fG 600 kHz	600 kHz
DC resistance, typ.	R 4,6 Ω	4,6 Ω
Series inductance, typ.	L 28 μH	28 μH
Capacitance, line-earth	C 1 nF	1 nF
Operating temperature range	TU -25 - +80 °C	-25 - +80 °C
Cross section for data line terminals	2.5 mm ² flexible with sleeve	
Cross section for earth connection terminals	6 mm ² flexible with sleeve	
Enclosure material / colour	Polycarbonate (halogen-free) UL 94-V0/yellow	
Degree of protection (IEC EN 60529)	IP 20	IP 20



Dimension drawing, see pages 194 to 198



EMC FILTER WITH INTEGRATED SURGE PROTECTION MCR TECHNOLOGY WITH INTEGRATED LOW-PASS FILTER

DataPro Z

To protect data and signal lines at measuring systems, automatic control devices and telecom installations. It is a compact protective circuit on a single printed circuit board (52 x 29 mm) which has been designed for the surge protection of sensitive electronic equipment. The DataPro Z is designed as a two-step coarse and

fine protective circuit. The coarse protection is provided by a gas-filled surge arrester (GDT) and the fine protection by EMI filter and suppressor diodes. Due to the absence of varistors, no leakage currents occur. Hence, there is no need of remote supervision respectively periodic inspection.

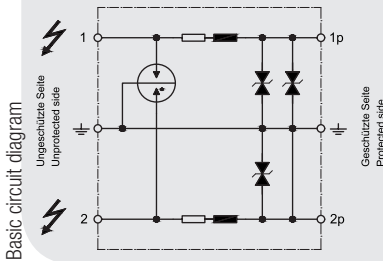
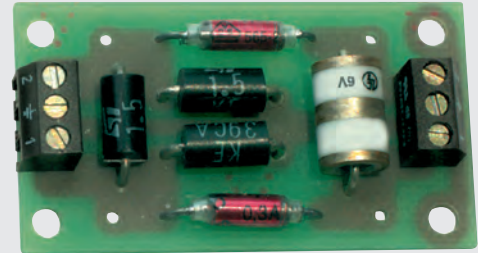

- Compact construction
- All-purpose application
- Nominal current up to 300 mA
- Many voltage variation

- High discharge capacity (line-PG: 20 kA at 8/20µs)
- Maintenance-free
- Budget-priced solution

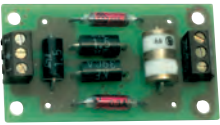
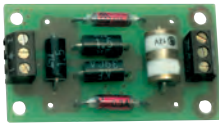
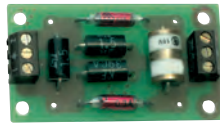
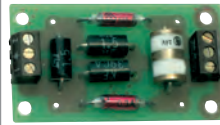
				
Technical Data	DataPro Z-6V/6V	DataPro Z-12V/12V	DataPro Z-15V/15V	DataPro Z-24V/24V
Article-No.	22 06 06	22 12 12	22 15 15	22 24 24
Nominal voltage DC	UN 6 V=	12 / 12 V=	15 / 15 V=	24 / 24 V=
Nominal current	IL 0,3 A	0,3 A	0,3 A	0,3 A
C2 nominal discharge current (8/20 µs) total	I _{max} 20 kA	20 kA	20 kA	20 kA
C2 nominal discharge current (8/20 µs) per line	I _n 10 kA	10 kA	10 kA	10 kA
Protection level at I _n (line-line)	U _p 9 V	18 V	22 V	36 V
Protection level at I _n (line-earth)	U _p 9 V	18 V	22 V	36 V
Transverse impedance per wire	R 4,1 Ω	4,1 Ω	4,1 Ω	4,1 Ω
Series inductance, typ.	L 40 µH	40 µH	40 µH	40 µH
Leakage current line-earth	400 µA	<5 µA	<5 µA	<5 µA
Leakage current line-line	400 µA	<5 µA	<5 µA	<5 µA

Dimension drawing, see pages 194 to 198

EMC FILTER WITH INTEGRATED SURGE PROTECTION MCR TECHNOLOGY WITH INTEGRATED LOW-PASS FILTER

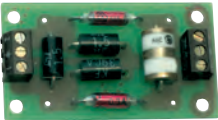
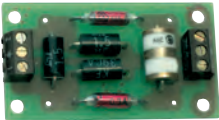
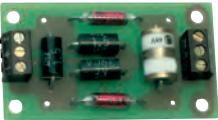
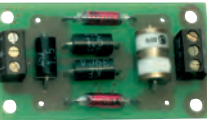

					
Technical Data		DataPro Z-30V/30V	DataPro Z-36V/36V	DataPro Z-48V/48V	DataPro Z-60V/60V
Article-No.		22 30 30	22 36 36	22 48 48	22 60 60
Nominal voltage DC	UN	30 / 30 V=	36/36 V=	48/48 V=	60/60 V=
Nominal current	IL	0,3 A	0,3 A	0,3 A	0,3 A
C2 nominal discharge current (8/20 μs) total	I _{max}	20 kA	20 kA	20 kA	20 kA
C2 nominal discharge current (8/20 μs) per line	I _n	10 kA	10 kA	10 kA	10 kA
Protection level at I _n (line-line)	U _p	43 V	52 V	65 V	83 V
Protection level at I _n (line-earth)	U _p	43 V	52 V	65 V	83 V
Transverse impedance per wire	R	4,1 Ω	4,1 Ω	4,1 Ω	4,1 Ω
Series inductance, typ.	L	40 μH	40 μH	40 μH	40 μH
Leakage current line-earth		<5 μA	<5 μA	<5 μA	<5 μA
Leakage current line-line		<5 μA	<5 μA	<5 μA	<5 μA

		
Technical Data		DataPro Z-RLC
Article-No.		23 00 00
Nominal voltage DC	UN	150 V=
Nominal current	IL	0,4 A
C2 nominal discharge current (8/20 μs) total	I _{max}	20 kA
C2 nominal discharge current (8/20 μs) per line	I _n	10 kA
Protection level at I _n (line-line)	U _p	... V
Protection level at I _n (line-earth)	U _p	600 V
Transverse impedance per wire	R	4,8 Ω
Series inductance, typ.	L	130 μH
Leakage current line-earth		<1 μA
Leakage current line-line		<1 μA

Dimension drawing, see pages 194 to 198

SMOOTH OPERATION GUARANTEED

The measuring and testing devices are applied to check the sparkover voltage of lightning or surge protectors. These periodical tests of the protective function are demanded by the standards to ensure a steady and error-free operation.

Down-time caused by overload of the surge protection can be eliminated by periodical reviews – with measuring and testing devices from Leutron.

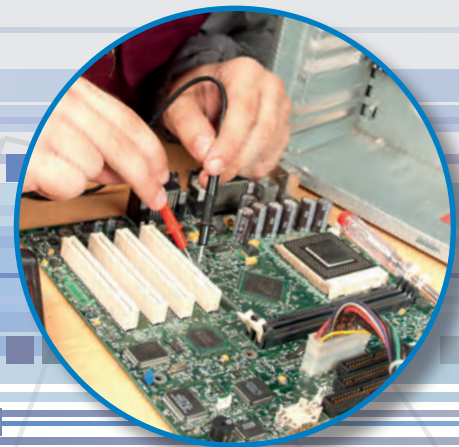

TESTED FOR SAFETY – MANUALLY OR AUTOMATICALLY:

- Manual measurement with the arrester tester, the varistor tester or the combined tester
- Fully automatic measurement with the portable test equipment for SSCT magazines
- Available adaptors for all types of gas-filled surge protectors



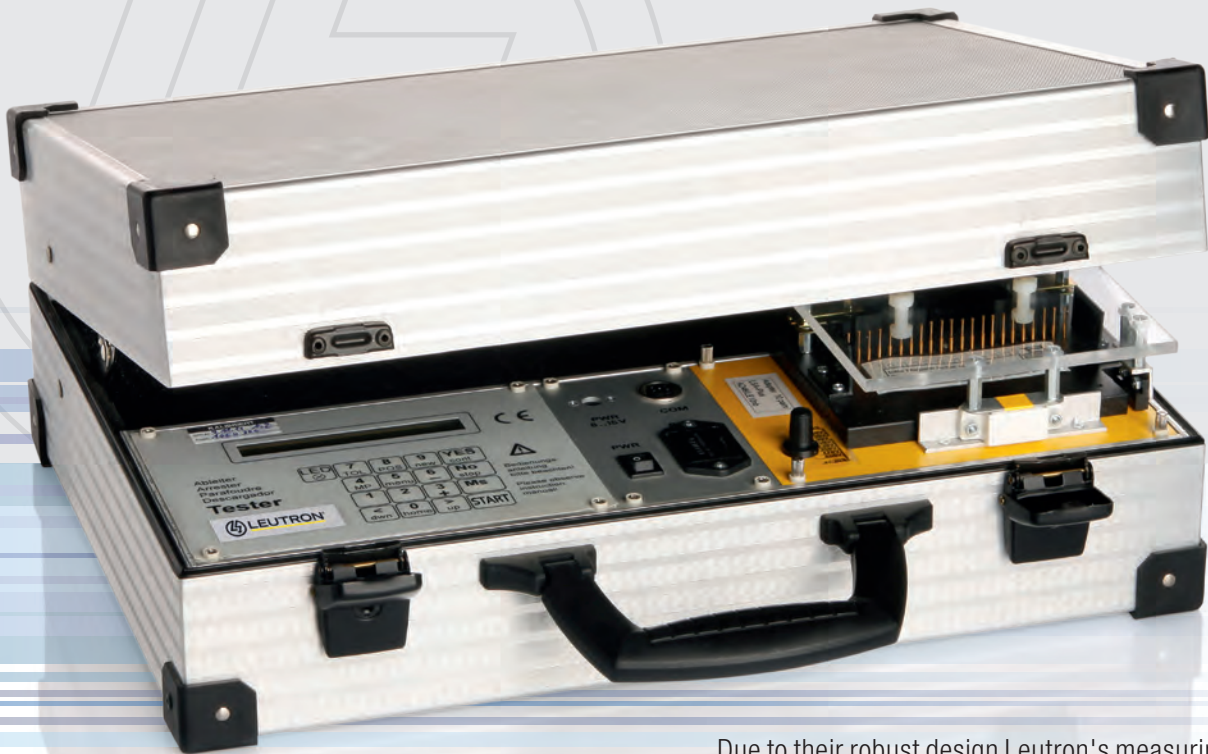

Due to their robust design Leutron's measuring and testing devices are perfectly suited for regular mobile use.

MONITORING

PORTABLE TEST EQUIPMENT FOR SSCT (LSA AND VS88) MAGAZINES

Variable adapters
for different types of
magazines

Fully automated test
of SSCT (LSA) and VS88
magazines for overvoltage
protection

PC interface for remote
control and
data archiving

Robust and mobile
set-up in an easy to
handle aluminium case





COMBINED TESTER

- To test the sparkover voltage of lightning or surge protectors, e.g. MOV and gas discharge tubes

Shipment in robust carrying case

Combined tester for gas discharge tubes, isolating spark gaps and varistors with a sparkover voltage of up to 1,100 V

Various adapters and measuring leads available





FUNCTION TESTER FOR GDT AND GDT BASED SPARK-GAPS

H35, H45, H65

- Digital measuring instrument with large LCD display
- 9V battery operation or net work power unit
- Measuring adapter (optional) for all popular GDT
- Automatic fixing of indicated value
- Scope of delivery includes: 1 carrying case, 1 test leads (2 pieces 1 m each), 2 test terminals, 1 external power supply 230V



H35 Function tester for GDT and GDT based spark-gaps

For the testing of spark over voltage of lightning and surge voltage arresters based on expulsion-type spark gap. Mobile, easy-to-handle digital meter with a large LCD display for maintenance.

H45 Function tester for MOV and overvoltage protection diodes.

For testing of the spark-over voltage of lightning- and surge voltage arresters. Digital measuring device with large LCD display. Mobile and easy-to-handle, usable for the service area.

H65 Universal function tester for GDT, MOV and diodes as well as mixed circuits

For the testing of spark over voltage of lightning and surge voltage arresters, e.g. metal oxide varistors (MOV) and gas-filled surge arrester (GDT) or individually MOV and GDT. It is a mobile, easy-to-handle and microprocessor operated digital meter with a large LCD display for maintenance.

Technical Data	H35	H45	H65
Article No.	87 00 10	16 02 00	87 01 50
Measured value display	LCD, digital [V]	LCD, digital [V]	LCD, digital [V]
Measuring range	40 - 1000 V	40 - 1100 V	40 - 1100 V
Max. testing voltage	1200 V	1200 V	1200 V
Test current	0,1mA	0,8-1,1 mA	0,8 - 1,1 mA
Display division	1 V	1 V	1 V
Testing period	min. 1s up to measuring value is seen	min. 1s up to measuring value is seen	min. 1s up to measuring value is seen
Rate-of-Rise (voltage)	1000 V /s	k. A.	1000 V/s
Batterie	9 V IEC 6F22/NEMA-1604-A	9 V IEC 6F22/NEMA-1604-A	9 V IEC 6F22/NEMA-1604-A
External AC/DC adapter	8 - 11 V DC/300 mA	230V AC / 8 -12 V DC / 200 mA	8 - 11 V DC / 200 mA
Typical current consumption in stand-by position	0,2 mA	0,2 mA	k.A.
Typical current consumption during measuring activity	35 mA	20 - 200 mA	20 - 200 mA
Typical current consumption display	k.A.	200 mA	ca. 1 mA
Test terminals (4mm banana jack)	Minus pole: black / Plus pole: red	Minus pole: black / Plus pole: red	Minus pole: black / Plus pole: red
Operating temperature range	-10 - +35 °C	-10 - +35 °C	-10 - +35 °C
Dimensions (L x W x H)	180 x 90 x 30 mm	180 x 90 x 30 mm	180 x 90 x 30 mm
Enclosure material / colour	self-extinguishing plastic / black	self-extinguishing plastic / black	self-extinguishing plastic / black
Net weight / pc	600 g	630 g	630 g

Accessories	Measuring adapter ADE/FGH:	Measuring adapter ADE/E :	Calibration of H65
Article No.	87 00 60	87 00 70	87 01 40



Measuring adapter ADE/FGH:
For two pole gas discharge tubes
8x8mm, 8x6mm, 8x20mm



Measuring adapter ADE/E :
For gas discharge tubes type E



Portable test equipment for GDT in LSA magazines

A46

For testing of LSA arrester magazines equipped with GDT. The whole test equipment is fixed in a portable case with place for a lot of accessories (e.g. AC- adapter, test adapter for different kind of GDT magazines).

At each test cycle each GDT arrester inserted in a magazine, the spark-over voltage in both polarities is analysed and compared with the tolerance values, adjusted in the test program.

For the testing of GDT equipped LSA magazines. The test equipment is embedded in a metal case which has additional space for accessories like network adapters and test adapters for different arrester magazines.

Each GDT in the magazine is tested on both polarities, and the static dc sparkover voltage is compared with the tolerance values.



- PC connection
- Individual tester can be stored in a PC or printed via included software
- Other test adapters are available on request
- Mobile device in aluminium protection case

Technical Data	A46-LSA	A46-VS88
Article No.	87 01 00	87 01 01
Slow ramp (CCITT/VDE)	100 V/s	100 V/s
Fast ramp	1000 V/s	1000 V/s
Measuring range	5-800 V	5-800 V
Test current	50 mA	50 mA
Resolution, internal	12 bit = 0,2 V	12 bit = 0,2 V
Display resolution	1 V	1 V
Accuracy	+/- 1 V +1 % rel.	+/- 1 V +1 % rel.
Resolution	0,2	0,2
Batterie	9 V IEC 22	9 V IEC 22
External AC/DC adapter	8-5 V / 50 mA	8-5 V / 50 mA
Typical current consumption in stand-by position	5 mA	5 mA
Typical current consumption during measuring activity	30 mA	30 mA
Max. usable positions	30 pos	30 pos
Net weight / pc	5000 g	5000 g

The A46 allows for an accurate measuring of the dc sparkover voltage, by detecting the first sparkover with a linear ramp. It is important to measure on both polarities in order to prevent damages to the gas-filled surge arrester.

The whole testing of the magazine takes place automatically, including the comparison of the measured values with the tolerance values and

the fault detection. The test of a complete magazine filled with 20 GDTs takes about 13 seconds.

A quality assessment system can be set up with the software PRO-TEST.

The A46 can operate entirely remote controlled from a PC via its serial interface. A special optocoupler-based cable is necessary to provide an interference protection for the PC.



Accessories	Calibration of A46
Article No.	87 00 30

Pulse counter

For the potential-free measurement of discharge currents of surge protective devices. Easy snap-on installation on the earth conductor with the help of an two-piece ring core.

- Pulse counting assembly in 1.5 TE DIN rail-mounted device
- including twisted sensor cable (length 1 m)
- Batteries are included in the delivery scope
- Push button to adjust the meter reading (e.g. after battery change)

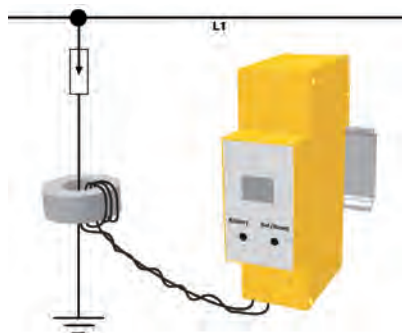

Technical Data	LC 1
Article No.	87 00 05
Impulse spark-over wave (rise time >8μs)	> 1 kA
Pulse frequency	< 1 s
LCD display	0 - 99
Power Supply	9 V-Batterie
Operating temperature range	TU -10 - +50 C°
Mounting on	35 mm DIN rail
Enclosure material / colour	Thermoplastic, yellow
Degree of protection (IEC EN 60529)	IP 20
Length of connection cable (sensor)	max. 1 m
Dimension (L x B x H)	63 x 27 x 90 mm
Sensor max. cross section	25 mm ²

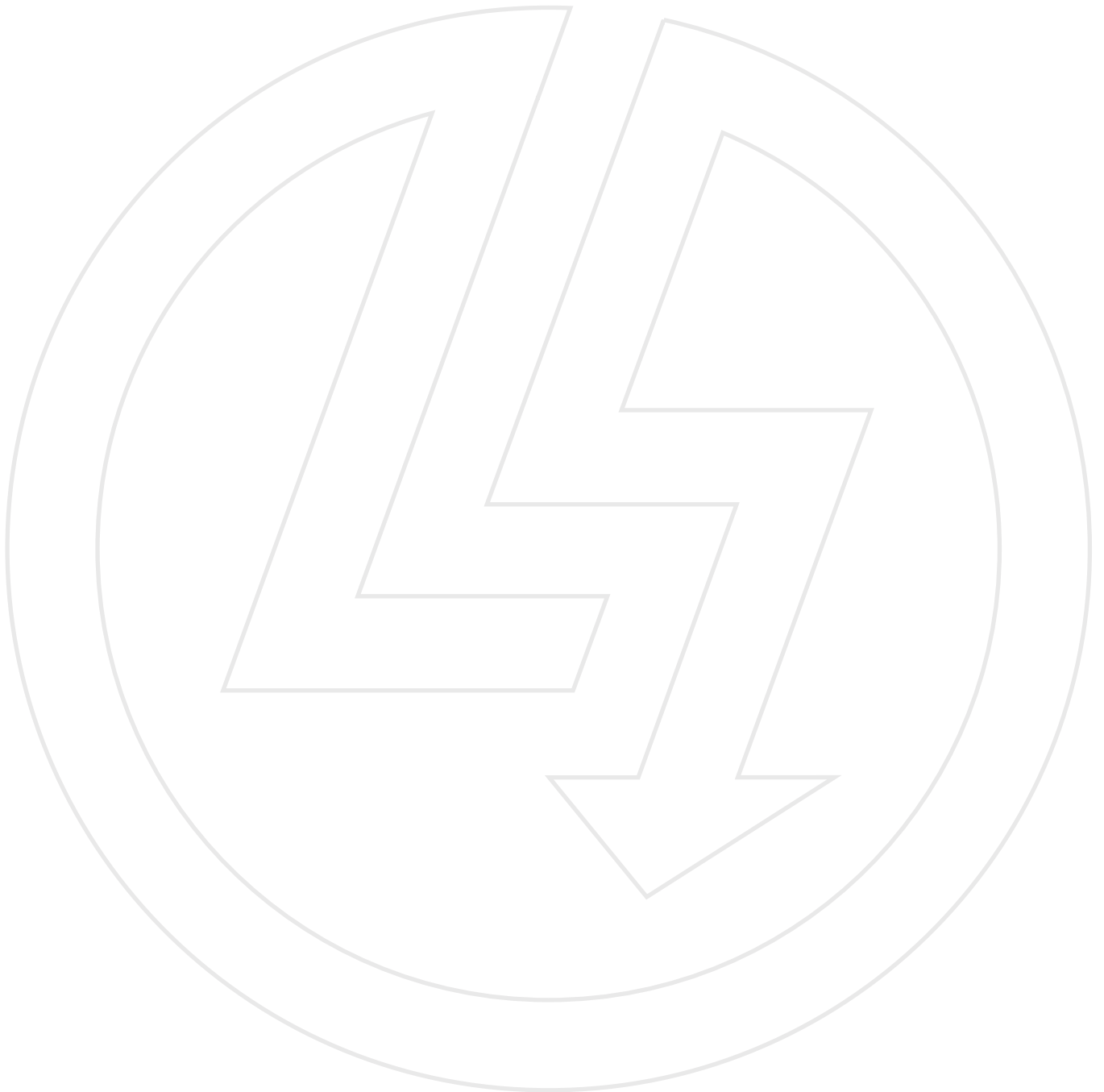

THE STRENGTHS OF LEUTRON SINCE 1947

The long experience and, therefore, the lead in research and development makes Leutron one of the leading manufacturers of isolation spark gaps. Intelligently designed components, compact constructions and an ideal choice of rare-gas fillings are only some elements that, in their totality, provide an optimal protection for various applications in the areas of electronics and electrical engineering.

Robust and powerful protection against direct lightning strikes – Leutron's isolation spark gaps.



GAS-FILLED ISOLATING SPARK GAPS FOR MORE SAFETY:

- Low DC and AC voltage protection level
- Very high ignition constancy even in demanding environments
- Maintenance-free due to automatic signalization in case of an overload
- Ideally suited for application in explosion-hazard environments
- Improved operator protection due to low sparkover voltage





Secure application
even in explosion-hazard environments

ISOLATING SPARK GAPS FILLED WITH RARE-GAS

Hermetically closed, gas-filled isolation spark gap

Fail-safe characteristic: The double fail-safe limits the surface temperature in case of a fault

Optional remote signalling on request



LEUTRON®

TSF 100- Tr
Trennfunkensstrecke
Isolating spark gaps
U_{ag}: 100V DC
I_{sn}: 100kA (8/20µs) **CE**
No. 44 90 80

PE

No. 44 90 80
I_{sn}: 100kA (8/20µs) **CE**
U_{ag}: 100V DC
Trennfunkensstrecke
Isolating spark gaps

ISOLATION SPARK GAPS FOR AREAS IN DANGER OF EXPLOSION: ATEX

- High discharge capacity up to 100 kA (10/350 μ s), class H
- Low sparkover voltage

Fail-safe characteristic: The double fail-safe limits the surface temperature in case of a fault

Hermetically closed, gas-filled isolation spark gap

Degree of protection IP 67 (according to IEC EN 60529), suited for outdoor application





RARE-GAS-FILLED INSULATION SPARK GAPS FREE MOUNTING

TSF 100 and 500

Rare-gas-filled spark gap for the lightning protection equipotential bonding, the insulation of electrically separated parts and the bridging of insulating flanges of gas pipelines.

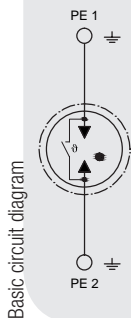

- High-quality industrial ceramics
- Rare-gas filled, hermetically sealed
- Free from radioactive substances
- High lightning current discharge capacity of 100 kA (10/350) (class H)
- High reliability, robust
- Stable performance, long service life
- Fail-safe characteristic
- Test standard EN 50164-3

			
Technical Data	TSF 50	TSF 100	TSF 500
Article-No.	44 90 60	44 90 69	48 78 01
IEC category/EN type	Class H	Class H	Class H
Nominal DC sparkover voltage at 100V/s	U _{agN} tbd.	100 ±20% V=	500 ±15% V=
Nominal AC sparkover voltage (50 Hz)	U _{aw} 50 ±15% V	70 ±20% V	350 ±15% V
Typical impulse sparkover voltage	U _{as} tbd.	650 V	950 V
Max. impulse sparkover voltage	U _{as} tbd.	950 V	1300 V
Lightning impulse current discharge capacity (10/350) I _{peak}	25 kA	100 kA	100 kA
Nominal impulse discharge current (10x 8/20) I _n	25 kA	100 kA	100 kA
5x Nominal alternating discharge current at 50Hz, 1s, 3min pause I _{wn}	tbd.	100 / 1 A	100 / 1 A
Nominal alternating discharge current (50 Hz)	tbd.	200 / 0,5 A	200 / 0,5 A
Spark-gap extinguishing conditions V _{io}	tbd.	<70V / <20A V	<230V / <100A V
Insulation resistance at 10V, 100V	> 1 GΩ	> 1 GΩ	>1 GΩ
Self-capacitance at 1 kHz	typ 6 pF	6 pF	4 pF
Test category/climatic category	DIN IEC 60068-1 / 40/90/21	DIN IEC 60068-1 / 40/90/21	DIN IEC 60068-1 / 40/90/21
Relative humidity	10%...95% rh	10%...95% rh	10%...95% rh
Degree of protection	IP 67	IP 67	IP 67
Operating temperature range TU	-40 - +80 °C	-40 - +80 °C	-40 - +80 °C
Terminals	M8 bolt/nut (NIROSTA stainless steel)		

Accessories	
Product	TSF-H1
Article-No.	44 91 75



For solid fixation of isolation spark gaps TSF 100 and TSF 500 at the installation.

Dimension drawing, see pages 194 to 198



SGO 70 and 350

Rare-gas-filled spark gap for the lightning protection equipotential bonding, the insulation of electrically separated parts and the bridging of insulating flanges of gas pipelines. Weather-resistant, moulded metal/ceramic isolating spark gap with terminal lugs for M8 screw connection. Waterproof moulded in polyurethane diecast.

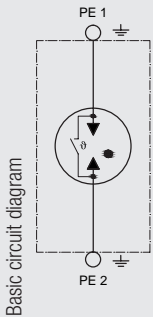

- High-quality industrial ceramics
- Rare-gas filled, hermetically sealed
- Free from radioactive substances
- High lightning current discharge capacity of 100 kA (10/350) (class H)
- Extremely low sparkover voltage
- High reliability, robust, waterproof
- Fail-safe characteristic
- Stable performance, long service life
- Test standard EN 50164-3

		
Technical Data	SGO 70	SGO 350
Article-No.	47 21 17	47 22 13
IEC category/EN type	Class H	Class H
Nominal DC sparkover voltage at 100V/s	UagN 100 ±20% V=	500 ±15% V=
Nominal AC sparkover voltage (50 Hz)	Uaw 70 ±20% V	350 ±15% V
Typical impulse sparkover voltage	Uas 650 V	950 V
Max. impulse sparkover voltage	Uas 950 V	1300 V
Lightning impulse current discharge capacity (10/350) Ipeak	100 kA	100 kA
Nominal impulse discharge current (10x 8/20) In	100 kA	100 kA
5x Nominal alternating discharge current at 50Hz, 1s, 3min pause Iwn	100 / 1 A	100 A
Nominal alternating discharge current (50 Hz)	200 / 0,5s A	200/0,5s A
Wechselstrom-Grenzbelastung (50Hz) Iwgr	4.000 / 0,25 A/s	4.000 / 0,25 A/s
Insulation resistance at 10V, 100V	>1 GΩ	>1 GΩ
Spark-gap extinguishing conditions VIö	<70V/ <20A V	< 230 V
Self-capacitance at 1 kHz	9 pF	7 pF
Test category/climatic category	DIN IEC 60068-1 / 40/90/21	DIN IEC 60068-1 / 40/90/21
Relative humidity	10%...95% rh	10%...95% rh
Degree of protection	IP 67	IP 67
Operating temperature range TU	-40 - +80 °C	-40 - +80 °C

Dimension drawing, see pages 194 to 198



RARE-GAS-FILLED INSULATION SPARK GAPS FREE MOUNTING

TA 100 and 500 C

Rare-gas-filled spark gap for the lightning protection equipotential bonding, the insulation of electrically separated parts and the bridging of insulating flanges of gas pipelines. The product is for outdoor use where a high level of protection against lightning and other climatic influences as well as mechanical stress is needed.



Basic circuit diagram

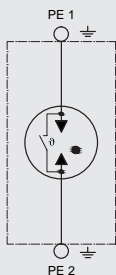

- High-quality industrial ceramics
- Rare-gas filled, hermetically sealed
- Free from radioactive substances
- High lightning current discharge capacity of 100 kA (10/350) (class H)
- High reliability, robust, waterproof
- Extremely low sparkover voltage
- Stable performance, long service life
- Fail-safe characteristic
- Test standard EN 50164-3

		
Technical Data	TA 100 C	TA 500 C
Article-No.	48 78 14	48 78 27
IEC category/EN type	Class H	Class H
Nominal DC sparkover voltage at 100V/s	U _{agN} 100 ±20% V=	500 ±15% V=
Nominal AC sparkover voltage (50 Hz)	U _{aw} 70 ±20% V	350 ±15% V
Typical impulse sparkover voltage	U _{as} 650 V	950 V
Max. impulse sparkover voltage	U _{as} 950 V	1300 V
Lightning impulse current discharge capacity (10/350) I _{peak}	100 kA	100 kA
Nominal impulse discharge current (10x 8/20) I _n	100 kA	100 kA
5x Nominal alternating discharge current at 50Hz, 1s, 3min pause I _{wn}	100 A	100 A
Nominal alternating discharge current (50 Hz)	200 / 0,5 A	200/0,5 A
Wechselstrom-Grenzbelastung (50Hz) I _{wgr}	4.000 / 0,25 A/s	4.000 / 0,25 A/s
Spark-gap extinguishing conditions V _{lö}	<70V / <20A V	< 230V/<100A V
Insulation resistance at 10V, 100V	>1 GΩ	>1 GΩ
Self-capacitance at 1 kHz	9 pF	7 pF
Test category/climatic category	DIN IEC 60068-1 / 40/90/21	DIN IEC 60068-1 / 40/90/21
Relative humidity	10%...95% rh	10%...95% rh
Degree of protection	IP 67	IP 67
Operating temperature range TU	-40 - + 80 °C	-40 - +80 °C

Accessories		
Product	IF3	IF1
Article-No.	82 30 16	82 30 11



Connecting brackets IF 1 (twin titled) and IF 3 (stretched) made from hot-dip zinc galvanized steel with 20 mm hole.

Dimension drawing, see pages 194 to 198



SGO 70 and 350 QA

Rare-gas-filled spark gap for the lightning protection equipotential bonding, the insulation of electrically separated parts and the bridging of insulating flanges of gas pipelines. Waterproof isolating spark-gap for underground installation (soil). Moulded in PU diecast, with cables.



Basic circuit diagram

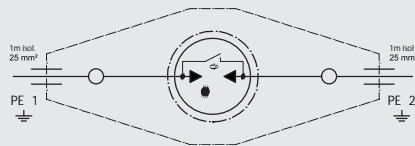

- High-quality industrial ceramics
- Rare-gas filled, hermetically sealed
- Free from radioactive substances
- High lightning current discharge capacity of 100 kA (10/350) (class H)
- Extremely low sparkover voltage
- Stable performance, long service life
- Fail-safe characteristic
- Including 2m or 0.5m connection cables with 25 mm² cross section
- SNAM execution
- Test standard EN 50164-3

					
Technical Data		SGO 70 QA	SGO 70 QA-S	SGO 350 QA	SGO 350 QA-S
Article-No.		47 21 04	47 21 05	47 21 11	47 21 12
IEC category/EN type		Class H	Class H	Class H	Class H
Nominal DC sparkover voltage at 100V/s	U _{agN}	100 ±20% V=	100 ±20% V=	500 ±15% V=	500 ±15% V=
Nominal AC sparkover voltage (50 Hz)	U _{aw}	70 ±20% V	70 ±20% V	350 ±15% V	350 ±15% V
Typical impulse sparkover voltage	U _{as}	650 V	650 V	950 V	950 V
Max. impulse sparkover voltage	U _{as}	950 V	950 V	1300 V	1300 V
Lightning impulse current discharge capacity (10/350) I _{peak}		100 kA	100 kA	100 kA	100 kA
Nominal impulse discharge current (10x 8/20)	I _n	100 kA	100 kA	100 kA	100 kA
5x Nennableitwechselstrom 50 Hz, 1s/3min Pause	I _{wN}	100/1 A	100/1 A	100/1 A	100/1 A
Nennableitwechselstrom (50 Hz)		200 / 0,5 A	200 / 0,5 A	200 / 0,5s A	200 / 0,5s A
Wechselstrom-Grenzbelastung (50 Hz)	I _{wgr}	4.000 / 0,25 A/s	4.000 / 0,25 A/s	4.000 / 0,25 A/s	4.000 / 0,25 A/s
Spark-gap extinguishing conditions	V _{i0}	< 70V / <20A V	< 70V / <20A V	< 230V/< 100A V	< 230V/< 100A V
Isolationswiderstand bei 10 V, 100 V		>1 GΩ	>1 GΩ	>1 GΩ	>1 GΩ
Eigenkapazität bei 1 kHz		9 pF	9 pF	7 pF	7 pF
Test category/climatic category		DIN IEC 60068-1 / 40/90/21	DIN IEC 60068-1 / 40/90/21	DIN IEC 60068-1 / 40/90/21	DIN IEC 60068-1 / 40/90/21
Relative humidity		10%...95% rh	10%...95% rh	10%...95% rh	10%...95% rh
Degree of protection		IP 67	IP 67	IP 67	IP 67
Operating temperature range	TU	-40 - +80 °C	-40 - +80 °C	-40 - +80 °C	-40 - +80 °C
Connection cable length/cross section		2 m/ 25 mm ²	0,5 m/ 25 mm ²	2 m/ 25 mm ²	0,5 m/ 25 mm ²
Total length with terminals	TU	≤ 4340 mm	1340 mm	≤ 4340 mm	1340 mm

Dimension drawing, see pages 194 to 198



RARE-GAS-FILLED INSULATION SPARK GAPS ATEX-CERTIFICATED FOR EXPLOSION HAZARDOUS ZONES

TC 100 and 500 A

ATEX approved Ex-protection category. Lightning-protective equipotential bonding in hazardous areas, e.g. insulating flanges at gas pipelines, at ca-thodic corrosion protection and protection of pressure transmitters.



Basic circuit diagram

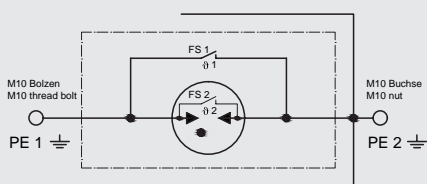

- High-quality industrial ceramics
- Rare-gas filled, hermetically sealed
- Free from radioactive substances
- Extremely low sparkover voltage
- High lightning current discharge capacity of 100 kA (10/350) (class H)
- High reliability, robust
- Stable performance, long service life
- Fail-safe behaviour (twofold)
- Patented product
- Test standard EN 50164-3

Technical Data	TC 100 A	TC 500 A
Article-No.	48 78 30	48 78 50
IEC category/EN type	Class H	Class H
Nominal DC sparkover voltage at 100V/s	U _{agN} 100 ±20% V=	500 ±15% V=
Nominal AC sparkover voltage (50 Hz)	U _{aw} 70 ±20% V	350 ±15% V
Typical impulse sparkover voltage	U _{as} 650 V	950 V
Max. impulse sparkover voltage	U _{as} 950 V	1300 V
Lightning impulse current discharge capacity (10/350) I _{peak}	100 kA	100 kA
Nominal impulse discharge current (10x 8/20)	I _n 10x 100 kA	100 kA
5x Nom. altern. disch. current at 50Hz, 1s, 3min pause	I _{wn} 100/s A	100 A
Nominal alternating discharge current (50 Hz)	200/0,5s A	200 / 0,5s A
Spark-gap extinguishing conditions	V _{lö} < 70V / < 20A V	< 230 V/ 100A V
Insulation resistance at 10V, 100V	>1 GΩ	>1 GΩ
Self-capacitance at 1 kHz	20 pF	20 pF
Test category/climatic category	DIN IEC 60068-1 / 40/90/21	DIN IEC 60068-1 / 40/90/21
Relative humidity	10%...95% rh	10%...95% rh
Degree of protection	IP 67	IP 67
ATEX Degree of protection	Ex II 2G EEx m II T3 (ZELM 02 ATEX 0095X)	EX II 2G EEx m II T3 (ZELM 02 ATEX 0095x)
Operating temperature range	TU -40 - +80 °C	- 40 - +80 °C

Accessories										
Product	K1/150	K1/300	K1/400	K1/500	K1/600	K1/750	K1/1000	K2/2000	IF3	IF1
Article-No.	49 51 06	49 51 08	49 51 05	49 51 04	49 51 11	49 51 12	49 51 13	49 51 14	82 30 16	82 30 11

Connecting cable sets K1/XXXX for TC 100A and TC 500A with cable length of 150 mm up to 1000 mm.

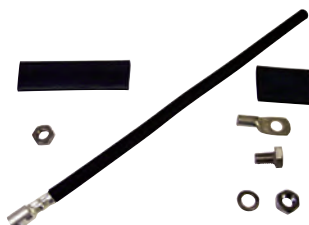

Connecting brackets IF 1 (twin titled) and IF 3 (stretched) made from hot-dip zinc galvanized steel with 20 mm hole.



Dimension drawing, see pages 194 to 198

Mounting: to bridge insulating flanges

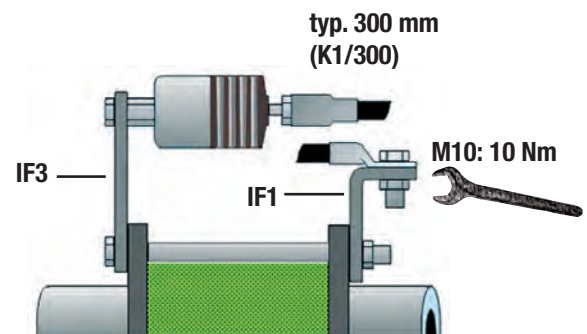
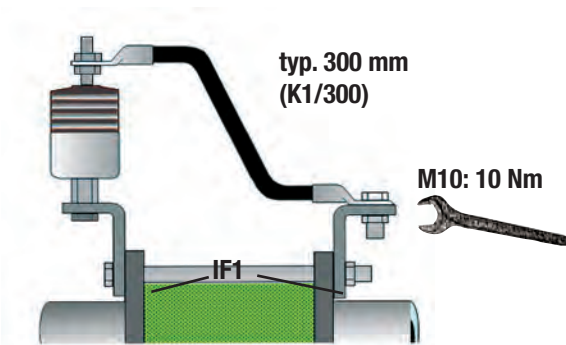

Use only tinned cable shoes or zinc plated connection parts (corrosion protection). All connections has to be safed by spring washer against shock and vibrations. For insulation parts, joint and flanges, as well as the GDT-Spark Gaps, it should not be able to be bridged by metal tools, metal parts, dirt, wast water or any current leading material.

Application examples

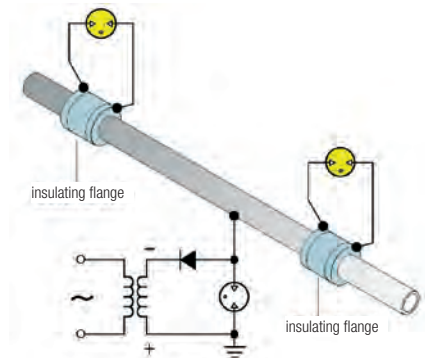
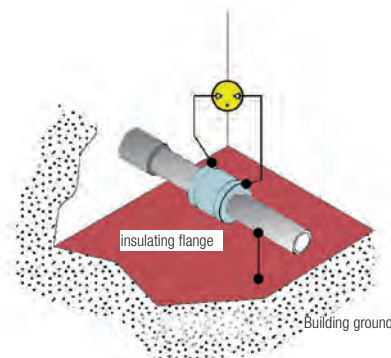
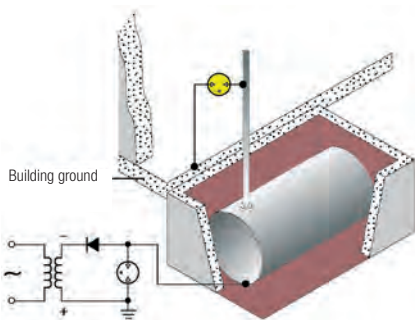

Description

Gasfilled spark gap for using in Ex areas.

- Filled with inert gas and hermetically sealed spark gap for Lightning protection equipotential bonding acc. to DIN EN 62305/VDE 0185 in Ex areas.
- For indirect lightning protective connection / grounding, of separate grounded electrical systems.
- To bridge insulation joints and parts, insulation flanges etc. in cathodic protected pipeline sections.
- For safe use in Ex-zones 1+2 (ex-hazardous gases up to temperature class T3) .





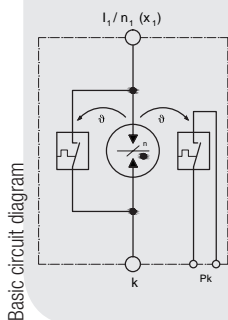

RARE-GAS-FILLED INSULATION SPARK GAPS DIN RAIL MOUNTING

TF for DIN rail mounting

Protects measuring transformers; lightning and surge voltage protector for 1A respectively 5A cores in current transformers.



- Very high impulse and AC current resistivity
- No blow-out vents, thus, not requiring any safety clearance to other installations
- High insulation resistance: $R_{iSO} > 10 \text{ G}\Omega$
- Very long service life
- Lightning impulse current discharge capacity 100 kA (10/350 μs)
- Remote signal contact (PK)

				
Technical Data	TF 100Tr/Th-Pk	TF 500-Tr	TF 500Tr/Th-Pk	TF 2000Tr/Th-Pk
Article-No.	53 43 72	53 43 98	53 43 85	55 04 11
DC spark-over voltage	$U_{ag} \quad 100 \pm 20\% \text{ V}=\$	$500 \pm 20\% \text{ V}=\$	$500 \pm 20\% \text{ V}=\$	$2000 (-10\% / +20\%) \text{ V}=\$
AC spark-over voltage	$U_{aw} \quad 70 \pm 20\% \text{ V}\sim$	$350 \pm 20\% \text{ V}\sim$	$350 \pm 20\% \text{ V}\sim$	$1414 (-10\% / +20\%) \text{ V}\sim$
Impulse sparkover voltage at 1 kV/ μs	$U_{as} \quad \text{typ. } 650 / \text{max. } 900 \text{ V}$	$\text{typ. } 1000 / \text{max. } 1300 \text{ V}$	$\text{typ. } 1000 / \text{max. } 1300 \text{ V}$	$< 3.000 \text{ V}$
Impulse sparkover voltage at 1 kV/ns (100 MHz)	$U_{as} \quad \text{typ. } 1600 / \text{max. } 1900 \text{ V}$	$\text{typ. } 2800 / \text{max. } 3000 \text{ V}$	$\text{typ. } 2800 / \text{max. } 3000 \text{ V}$	n. d.
Capacitance	$C \leq 18 \text{ nF}$	$\leq 6 \text{ nF}$	$\leq 16 \text{ nF}$	$\leq 16 \text{ nF}$
Insulation resistance at 10 V	$R_{iSO} \geq 1 \text{ G}\Omega$	$\geq 1 \text{ G}\Omega$	$\geq 1 \text{ G}\Omega$	$\geq 1 \text{ G}\Omega$
Nominal discharge current (8/20)	$I_n \quad 10 \times 100 \text{ kA}$	$10 \times 100 \text{ kA}$	$10 \times 100 \text{ kA}$	$10 \times 60 \text{ kA}$
Lightning impulse current (10/350) (limp) + long-time current 200 A/0.5 s/100 As	$I_{peak} \quad 1 \times 100 \text{ kA}$	$1 \times 100 \text{ kA}$	$1 \times 100 \text{ kA}$	$1 \times 60 \text{ kA}$
Lightning impulse current (10/350) (limp) + long-time current 200 A/0.5 s/100 As	$Q \quad 50 \text{ As}$	50 As	50 As	30 As
Lightning impulse current (10/350) (limp) + long-time current 200 A/0.5 s/100 As	$W/R \quad 2500 \text{ kJ}/\Omega$	$2500 \text{ kJ}/\Omega$	$2500 \text{ kJ}/\Omega$	$900 \text{ kJ}/\Omega$
Lightning impulse current limp (10/45 μs) + half-wave 1.6 kA (DIN 48810)	$I_{peak} \quad 20 \times 60 \text{ kA}$	$20 \times 60 \text{ kA}$	$20 \times 60 \text{ kA}$	$20 \times 60 \text{ kA}$
Lightning impulse current limp (10/45 μs) + half-wave 1.6 kA (DIN 48810)	$Q \quad 10 \text{ As}$	10 As	10 As	10 As
Lightning impulse current limp (10/45 μs) + half-wave 1.6 kA (DIN 48810)	$W/R \quad 100 \text{ kJ}/\Omega$	$100 \text{ kJ}/\Omega$	$100 \text{ kJ}/\Omega$	$100 \text{ kJ}/\Omega$
5x Nominal alternating discharge current at 50Hz, 1s, 3min pause	$I_{wn} \quad 100 \text{ A}$	100 A	100 A	100 A
Operating temperature range	$TU \quad -40 - +75 \text{ }^\circ\text{C}$	$-40 - +75 \text{ }^\circ\text{C}$	$-40 - +75 \text{ }^\circ\text{C}$	$-40 - +75 \text{ }^\circ\text{C}$
Conductor cross section	25 mm^2	25 mm^2	25 mm^2	25 mm^2
Max. connection torque for terminals	$4,5 \text{ Nm}$	$4,5 \text{ Nm}$	$4,5 \text{ Nm}$	$4,5 \text{ Nm}$

Dimension drawing, see pages 194 to 198



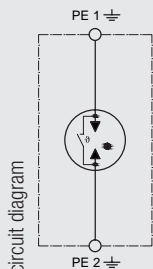

TSF for DIN rail mounting

Rare-gas-filled spark gap for the lightning protection equipotential bonding, the insulation of electrically separated parts and the bridging of insulating flanges of gas pipelines.



Basic circuit diagram

- Light. imp. current resistance (10/350µs): 100 kA
- Mounting on 35 mm DIN rail
- Test standard EN 50164-3
- Degree of protection nach IEC EN 60529: IP 20

			
Technical Data	TSF 50-Tr	TSF 100-Tr	TSF 500-Tr
Article-No.	44 90 76	44 90 80	44 90 85
IEC category/EN type	Class 1L	Class H	Class H
Nominal DC sparkover voltage at 100V/s	UagN n. d.	100 ±20% V=	500 ±20% V=
Nominal AC sparkover voltage (50 Hz)	Uaw 50 ±15% V	70 ±20% V	350 ±20% V
Typical impulse sparkover voltage	Uas n. d.	650 V	950 V
Max. impulse sparkover voltage	Uas n. d.	950 V	1300 V
Lightning impulse current discharge capacity (10/350) Ipeak	25 kA	100 kA	100 kA
Nominal impulse discharge current (10x 8/20) In	25 kA	100 kA	100 kA
5x Nominal alternating discharge current at 50Hz, 1s, 3min pause	Iwn n. d.	100 A	100/1 A
Nominal alternating discharge current (50 Hz)	n. d.	200 A / 0,5s A	200/0,5s A
Alternating current critical load (50 Hz) Iwgr	n. d.	4.000 A / 0,25s A/s	4000/0,25 A/s
Spark-gap extinguishing conditions	n. d.	<70V / < 20A V	< 230 V / < 100 A V
Insulation resistance at 10V, 100V	>1 GΩ	>1 GΩ	> 1 GΩ
Self-capacitance at 1 kHz	6 pF	6 pF	4 pF
Test category/climatic category	DIN IEC 60068-1 / 40/90/21	DIN IEC 60068-1 / 40/90/21	DIN IEC 60068-1 / 40/90/21
Relative humidity	10%...95% rh	10%...95% rh	10%-95% rh
Operating temperature range	TU -40 - +80 °C	-40 - +80 °C	-40 - +80 °C
Max. conductor cross section	50mm ² stranded/35mm ² flexible	50mm ² stranded/35mm ² flexible	50mm ² stranded/35mm ² flexible

Dimension drawing, see pages 194 to 198

SMALLER, MORE COMPACT AND MOST EFFICIENT

Extended metal structures like gas pipelines are endangered by induced AC voltages from high-voltage overhead lines and suchlike. These voltages can cause corrosion and pitting and, therefore, have to be diverted. Leutron's PLPro is the most compact and, at the same time, most robust solution available for such problems.

The application of Leutron's worldwide tried and tested technology saves time and money.



PROTECTION OF OUTDOOR INSTALLATIONS:

- Monitoring possible by remote measurement of the current flow
- Lightning current carrying capacity up to lightning protection level LPL 1
- No interference with detection signals on pipelines
- Cascadable, i.e., adaptable to the value of the current to divert
- Reliable diversion of harmful AC voltages in metal structures





Leutron's protective devices are maintenance-free due to enclosed arresters

PIPELINE PROTECTION DEVICES FOR AC APPLICATION

AC CURRENT DIVERTER FOR 80 A FOR THE PROTECTION OF CATHODIC CORROSION PROTECTION SYSTEMS (CCPS) OF PIPELINES

- High discharge capacity up to 100 kA (10/350 μ s), class H
- Low sparkover voltage

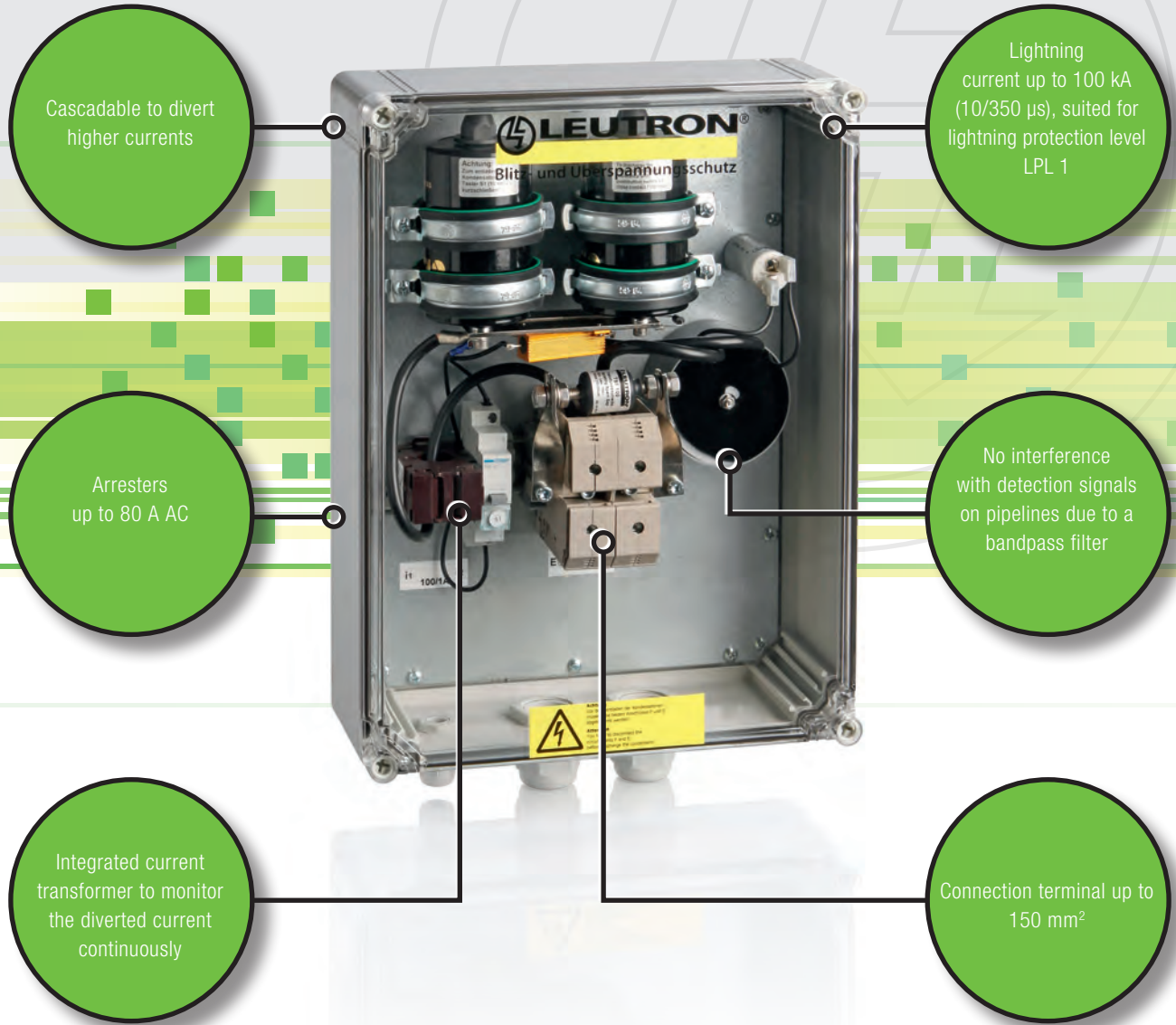

Cascadable to divert higher currents

Lightning current up to 100 kA (10/350 μ s), suited for lightning protection level LPL 1

Arresters up to 80 A AC

No interference with detection signals on pipelines due to a bandpass filter

Integrated current transformer to monitor the diverted current continuously

Connection terminal up to 150 mm²



REFERENCE: V&C KATHODISCHER KORROSIONSSCHUTZ GES.M.B.H., AUSTRIA

»For a number of years we now use Leutron's PLPro system to divert alternating currents. The systems installed so far operate smoothly, and we never received any complaints from customers. At the insulating flanges of our cathodic corrosion protection systems we very often apply ATEX certified isolation spark gaps TC 100 A. They too work to the satisfaction of our customers. So far no malfunction or break-down occurred.«





PROTECTIVE DEVICES FOR AC APPLICATION

AC-CURRENT DIVERTER UP TO AC 80A WITH LIGHTNING PROTECTION

PLPro

With an active cathodic corrosion protection the installation is permanently protected against the electrochemical process of corrosion. For that matter a grid supplied rectifier is inserted between the installation (e.g. a pipeline) and an anode that serves as earth electrode. By connecting two or three PLPro units in parallel the overall current can be elevated up to 80 A respectively 120 A.



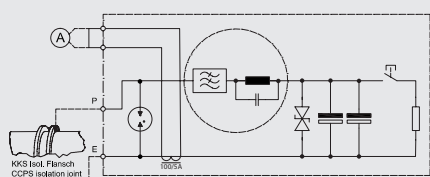

Basic circuit diagram



- AC discharge current: 40 or 80 A
- Several PLPro devices can be connected in parallel to raise the total discharge current
- Maintenance-free, without liquids
- No disturbance of search signals

- Monitoring of discharge current with integrated current transformer possible
- Integrated lightning and surge current protection up to 100 kA (10/350 μ s)
- Safety switch for discharging the capacitors

		
Technical Data	PLPro-40A-iv	PLPro-80A-iv
Article-No.	55 04 40	55 04 41
Rated voltage (P-E)	U _{max} 25 V=	25 V=
Max. continuous diverting current 50Hz (P-E)	I _A 40 A~	80 A~
Short-time discharge current for 1s/50Hz (P-E)	I _{max} 400 A~	400 A~
Leakage current (P-E)	I _L ≤ 1 mA	≤ 1 mA
Nominal discharge current (8/20 μ s) (P-E)	I _n 10x 100 kA	10x 100 kA
Lightning impulse current (10/350)	I _{imp} 100 kA	100 kA
Operating temperature range	TU -40 - +80 °C	-40 - +80 °C
Terminals (P/E)	min. 16 / max. 150 mm ²	min. 16/max. 150 mm ²
Current transformer	100:1 A	100:1 A
Terminals (current transformer i1, i2)	25 mm ²	max. 2,5 mm ²
Terminals (current transformer i1, i2)	T -20 - +45 °C	-20 - +45 °C
Power terminal	105 mm ²	105 mm ²
Mounting type	wall mounting	wall mounting
Dimensions (L x W x H)	400 x 300 x 132 mm	600 x 400 x 132 mm
Degree of protection (IEC EN 60529)	IP 65	IP 65

Dimension drawing, see pages 194 to 198



EnerPro CV 2P xxV/63A-LED

These devices are predominantly used for cathodic corrosion protection systems at gas and oil pipelines with bitumen insulation layer.

- Mounting directly on DIN rail
- Operating current up to 63 A
- Version with and without LED available
- Leakage current-free

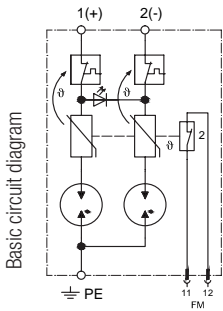

Technical Data	EP CV 2P 65V/63A-LED	EP CV 2P 100V/63A-LED
Article-No.	38 20 80	38 20 86
Nominal voltage DC	UN 30 V=	100 V=
Nominal voltage AC	UN 36 V~	75 V~
Max. continuous operating voltage DC	Uc 65 V=	125 V=
Max. continuous operating voltage AC	Uc 45 V~	95 V~
Max. allowed prefuse	63 A gL/gG	63 A gL
Voltage protection level (1kV/μs)	Up ≤ 0,55 kV	
Protection level at 1 kV/μs (1, 2-PE)	Uas ≤ 0,55 kV	≤ 0,6 kV
Response time	tA 50 ns	550 ns
Nominal impulse discharge current (8/20)	In 20 kA	20 kA
Max. impulse discharge current (8/20)	Imax 40 kA	50 kA
Lightning impulse current (10/350 μs) per pole	Iimp 5 (2,5 As) kA	5 (2,5 As) kA
Operating temperature range	TU -40 - +80 °C	-40 - +80 °C
Max. Conductor cross section (1, 2 and PE)	50mm ² stranded/35mm ² flexible	
Max. connection torque for terminals	4,5 Nm	4,5 Nm
Enclosure material / colour	polycarbonate (halogen-free) UL 94-V0 / yellow	
Degree of protection (IEC EN 60529)	IP 20	IP 20
Mounting on	DIN rail 35 mm (DIN EN 50 022)	
with remote signalling contact (FM)	EP CV 2P 65V/63A/FM-LED	EP CV 2P 100V/63A/FM-LED
Article-No.	38 20 83	38 20 87
Max. switching capacity of remote signal contact	AC: 250V/0,5A //DC: 250V/0,1A	AC: 250V/0,5A //DC: 250V/0,1A
Max. cross section of the remote signalling line	1,5 mm ²	1,5 mm ²

EnerPro 65V/12A-Tr

Two-pole USP for operating currents up to 12 A and a nominal impulse discharge current of 20 kA (8/20 μs) for sensitive electronic devices.

- Two-stage design
- High performance surge protector
- Mounting on 35 mm DIN rail
- Operating current: 12 A
- Maximum acceptable DC continuous operating voltage of 65 V DC
- With filter

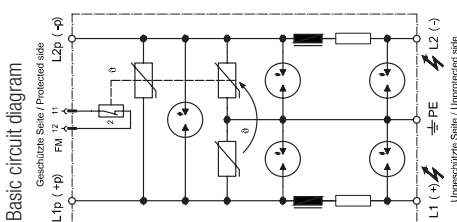

Technical Data	EnerPro 65V/12A-Tr	EnerPro 65V/12A-Tr/FM
Article-No.	29 60 00	29 60 02
Max. continuous operating voltage DC	Uc 65 V=	65 V=
Rated load current	IL 12 A	12 A
Protection level at 1kV/μs	Up ≤ 350 V	≤ 350 V
Nominal impulse discharge current (8/20)	In 20 kA	20 kA
Response time	tA ≤ 25 ns	≤ 25 ns
Max. impulse discharge current (8/20)	Imax 40 kA	40 kA
Lightning impulse current (10/350 μs) per pole	Iimp 5 (2,5 As) kA	5 (2,5 As) kA
Nominal alternating discharge current (50Hz)	20 (5x1s, 50Hz, 3min. Pause) A	20 (5x1s, 50Hz, 3min. Pause) A
Max. conductor cross section	50mm ² stranded/35mm ² flexible	50mm ² stranded/35mm ² flexible
Operating temperature range	TU -40 - +80 °C	-40 - +80 °C
Max. connection torque for terminals	4,5 Nm	4,5 Nm
Enclosure material / colour	polycarbonate (halogen-free) UL 94-V0 / yellow	
Degree of protection (IEC EN 60529)	IP 20	IP 20
Mounting on	DIN rail 35 mm (DIN EN 50 022)	
FM contact / contact type		break contact
Switching capacity		250 V/2 A

Dimension drawing, see pages 194 to 198



Protection system for Cathodic Corrosion Protection (schematic diagram)

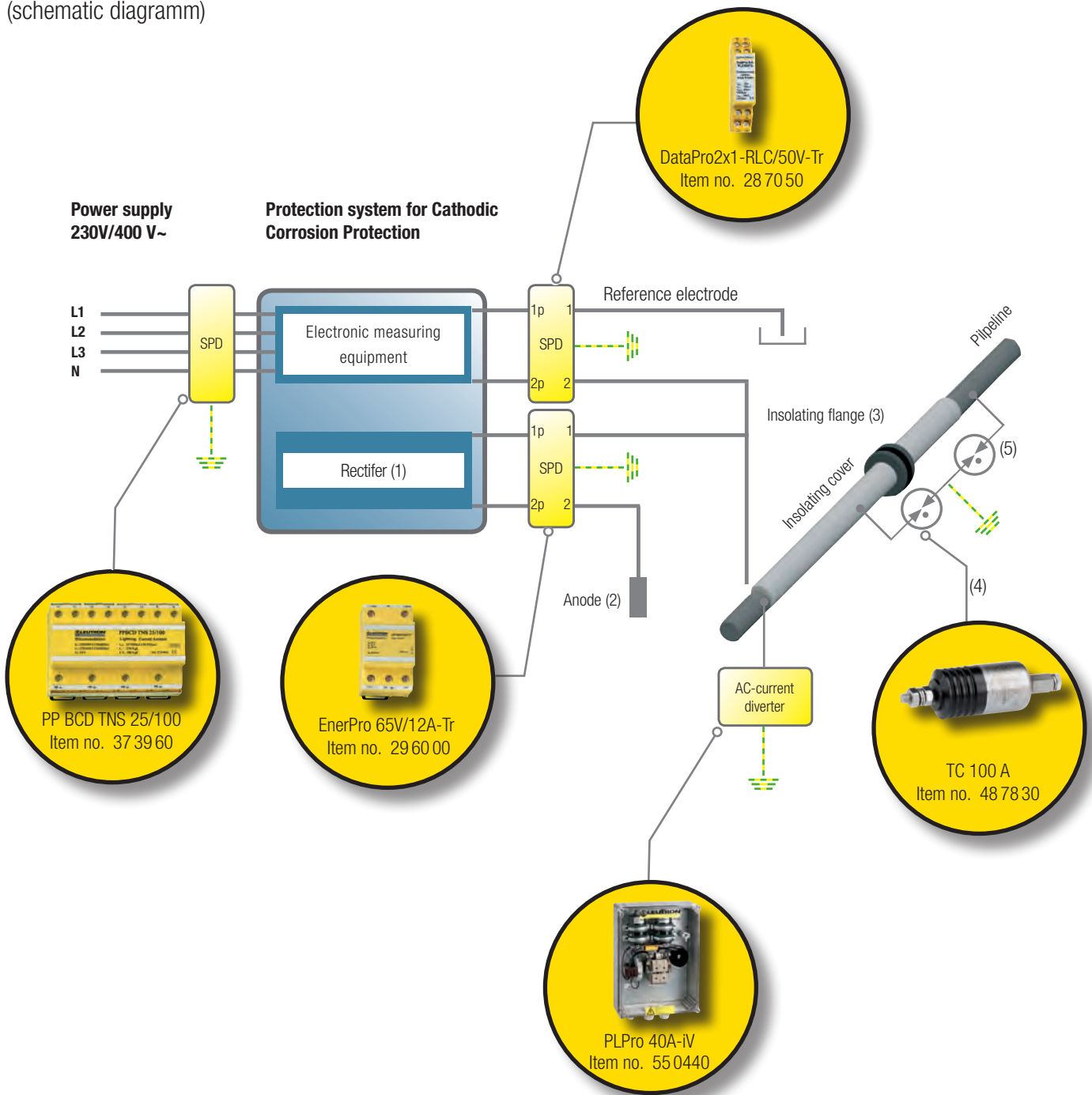

Properties of PLPro:

- Integrated lightning and surge current protection up to 100 kA (10/350 μ s)
- High impulse discharge current
- Safety switch for discharging the capacitors
- Does not have to be disconnected during leakage detection with HF detector (10 kHz)
- Can be mounted in a weather-proof outdoor cabinet or box without further protection measures
- Built-in measuring circuit with analogue display for ac discharge current
- No danger for operating personnel
- Maintenance-free

In general, PLPro consists of five components:

- AC discharge unit, consisting of high-performance capacities (2 pieces per 40 A)
- Surge protection device (fine protection) for the capacitors
- Measurement of the discharge current 100/1 A, AC current transformer, indicating instrument (on request)
- 10 kHz band-elimination filter which prevents the diversion of the 10 kHz search frequency of the leakage detectors against earth
- Lightning protection (coarse protection) by rare-gas-filled isolating spark gap 100 kA (10/350 μ s) with low sparkover voltage



Test Standards

DIN EN 61643-11

VDE 0675-6-11:2013-04

Low-voltage surge protective devices - Part 11: Surge protective devices connected to low-voltage power systems - Requirements and tests (IEC61643-1:1998 + corrigendum 1998, modified); German version EN 61643-11:2013-04

IEC 61643-1:2011-03

Low-voltage surge protective devices - Part 11: Surge protective devices connected to low-voltage power systems - Requirements and test methods

DIN EN 61643-21

VDE 0845-3-1:2010-03

Low voltage surge protective devices - Part 21: Surge protective devices connected to telecommunications and signalling networks - Performance requirements and test methods (IEC61643-21:2000 + Corrigendum 2001 + A1:2008, modified); German version EN 61643-21:2001 + A1:2009

IEC 61643-21 (2009-04) Ed. 1.1

IEC 61643-21:2000 + A1:2008

Low voltage surge protective devices - Part 21: Surge protective devices connected to telecommunications and signalling networks - Performance requirements and testing methods

DIN EN 50164-3

VDE 0185-203:2009-09

Lightning Protection Components (LPC) - Part 3: Requirements for isolating spark gaps; German version EN 50164-3:2006 + A1:2009

DIN EN 60715:2001-09

Dimensions of low-voltage switchgear and controlgear - Standardized mounting on rails for mechanical support of electrical devices in switchgear and controlgear installations (IEC 60715:1981 + A1:1995); German version EN 60715:2001

DIN EN 60529

VDE 0470-1:2000-09

Degrees of protection provided by enclosures (IP code) (IEC 60529:1989 + A1:1999); German version EN 60529:1991 + A1:2000

IEC 60529 (2001-02) Ed. 2.1

Degrees of protection provided by enclosures (IP Code)

DIN EN 60068-2-6:2008-10; VDE 0468-2-6:2008-10

Environmental testing - Part 2-6: Tests - Test Fc: Vibration (sinusoidal) (IEC 60068-2-6:2007); German version EN 60068-2-6:2008

DIN EN 60068-2-27:2010-02; VDE 0468-2-27:2010-02

Environmental testing - Part 2-27: Tests - Test Ea and guidance: Shock (IEC 60068-2-27:2008); German version EN 60068-2-27:2009

Application standards

DIN VDE 0100-443:2007-06,

Low voltage electrical installations, Part 4-44: Protection against voltage disturbances and electromagnetic disturbances - Clause 443: Protection against overvoltages of atmospheric origin or due to switching (IEC 60364-4-44:2001 + A1:2003, modified); German implementation HD 60364-4-443:2006

DIN VDE 0100-534:2009-02,

Low voltage electrical installations, Part 5-53: Selection and erection of electrical equipment - isolating, switching and control - clause 534: Devices for protection against overvoltages (IEC 60364-5-53:2001/A1:2002, modified); German implementation HD 60364-5-534:2008

DIN VDE 0100-100:2009-06

Low voltage electrical installations, Part 1: Fundamental principles, assessments of general characteristics, definitions (IEC 60364-1:2005, modified); German implementation HD 60364-1:2008

DIN VDE 0100-410:2007-06

Low voltage electrical installations, Part 4-41: Protection for safety - Protection against electric shock (IEC 60364-4-41:2005, modified); German implementation HD 60364-4-41:2007

DIN EN 62305-1

VDE 0185-305-1:2011-10

Protection against lightning - Part 1: General principles (IEC 62305-1:2010, modified); German version EN 62305-1:2011

DIN EN 62305-2

VDE 0185-305-2: 2006-10

Protection against lightning - Part 2: Risk management (IEC 62305-2:2006); German version EN 62305-2:2006

DIN EN 62305-3

VDE 0185-305-3: 2011-10

Protection against lightning - Part 3: Physical damage to structures and life hazard (IEC 62305-3:2010, modified); German version EN 62305-3:2011

DIN EN 62305-4

VDE 0185-305-4:2011-10

Protection against lightning - Part 4: Electrical and electronic systems within structures (IEC 62305-4:2010, modified); German version EN 62305-4:2011

IEC 62305-1 (2010-12) Ed. 2.0

Protection against lightning - Part 1: General principles

IEC 62305-2 (2010-12) Ed. 2.0

Protection against lightning - Part 2: Risk management

IEC 62305-3 (2010-12) Ed. 2.0

Protection against lightning - Part 3: Physical damage to structures and life hazard

IEC 62305-4 (2010-12) Ed. 2.0

Protection against lightning - Part 4: Electrical and electronic systems within structures

LEUTRON PROTECTS THE FUTURE

Because photovoltaic systems (among other things) are the future. Whether for new buildings or for renovations, for private residences or for office buildings: these systems are being installed on more and more roofs across the world.

In addition to the modules, the photovoltaic system is also integrated into the building's electrical systems, which are necessarily vulnerable to direct or indirect lightning strikes.

Lightning strikes and power surges have serious consequences: aside from production losses, there are also high repair costs - Costs that Leutron can keep down.



LEUTRON PROTECTS PHOTOVOLTAIC SYSTEMS UP TO 1000 V DC

- External lightning protection
- Use und dimensioning of Surge Protective Devices

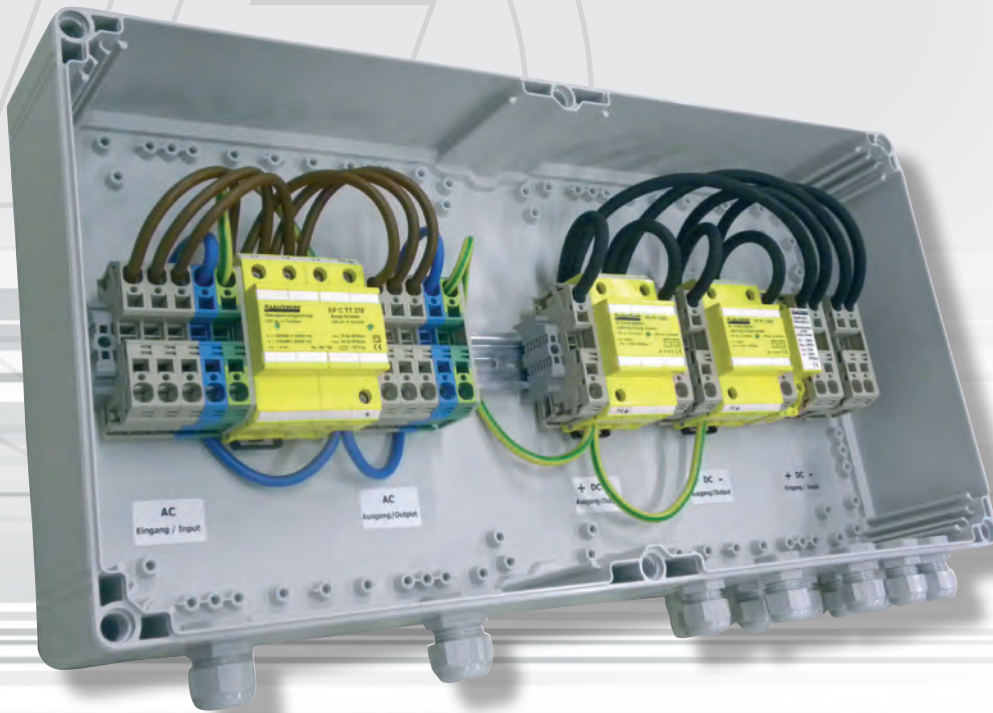

High-quality protection devices for Photovoltaic systems:
Generator Connection Box with Surge Protection Devices

SURGE PROTECTION OF PV SYSTEMS

ALL-ROUND PROTECTION WITH GENERATOR CONNECTION BOXES

- Efficient installation: Several strings of the PV arrangement are brought together in one point
- Cable installation without effort
- Realization of projects are flexible, safe and economical
- Thanks of SPD type 1+2 (class I+II) effective surge protection is real

High-quality
Components

Through terminals
max. 16 mm²

Cables inlet bottom

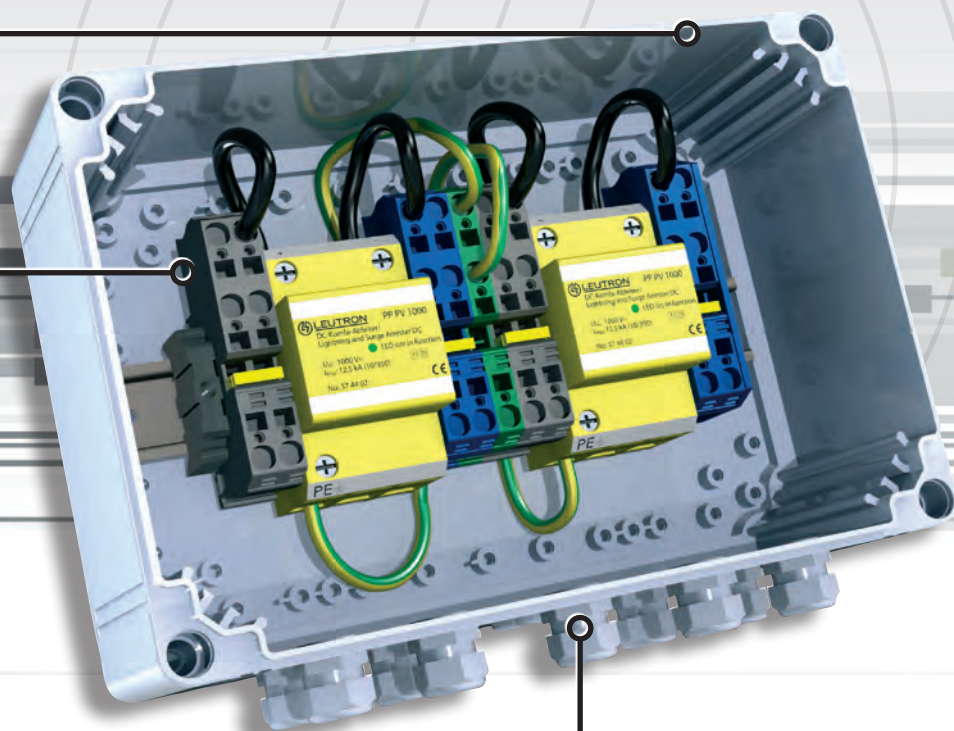

SELECTION GENERATOR CONNECTION BOXES

- Open-circuit voltage of the strings
- Number of the strings
- Number of the MPP tracker



CHARACTERISTICS OF GENERATOR CONNECTION BOXES

- For DC or DC/AC installations
- With or without remote monitoring
- For the use with string fuses and string diodes
- For outdoor installation
- UV resistance
- Protection class II

DC and AC side
protected in only one
stable housing

AC-SPD

DC-SPD Type 1+2

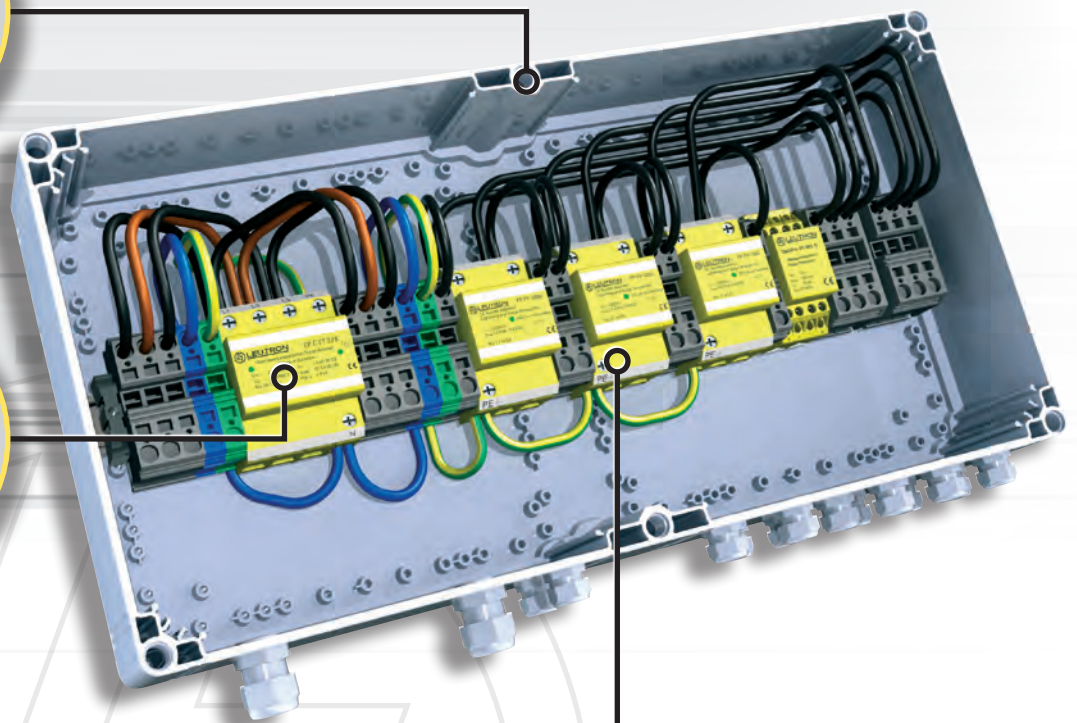



GENERATOR CONNECTION BOXES

GAK WITHOUT STRING FUSES

GAK 3/3

Generator connection box for one inverter with one MPP tracker and maximum eight terminal points per plus and minus pole.

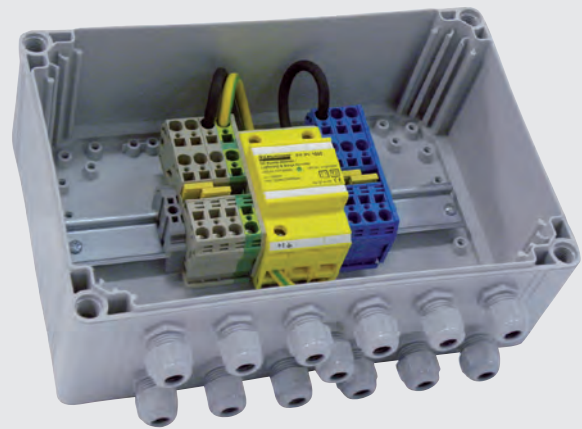

Example image

- Housing of surface mounting (300 x 200 x 132 mm) / IP66
- 8 Terminal points are arbitrary (e. g. for 4x Input terminal and 4x output terminal)
- One SPD type 1+2 with 1000 V
- Variants with remote signalling contact also available (on request)
- Terminals can be used as points of measurement



Technical Data	PV DC 4.1000-2-S1
Article-No.	80 00 82
Max. system voltage	1000 V=
Max. current per input terminal (+)	57 A
Max. current per output terminal	57 A
Operating temperature range	TU -40 - +80 °C
Cross section for E-terminals (input)	16 mm ²
Cross section for A-terminals (output)	16mm ² single wire. / stranded
Cable feedthrough	13x M16
Degree of protection (IEC EN 60529)	IP 66
Installation dimensions (W x H x D)	300 x 200 x 132 mm
SPD acc. to EN 61643-11	Type 1 + 2 / class I + II

Dimension drawing, see pages 194 to 198



GAK 4/4



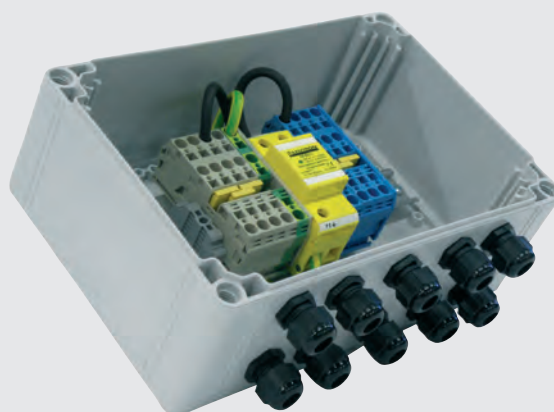

Generator connection box with ten terminal points. The connected plus and minus pol terminals for the input and output strings are free selectable.

Application: to protect inverter with one MPP tracker in PV systems



Example image

- Housing of surface mounting (300 x 200 x 132 mm) / IP66
- Degree of protection (IEC EN 60529)
- 10 Terminal points are arbitrary (e. g. for 5x input terminal and 5x output terminal)
- One arrester 800 or 1000 V, T2 or T1 + T2
- Variants with remote signalling contact also available (on request)
- Terminals can be used as points of measurement

				
Technical Data	GAK 4/4/1xT2 800V	GAK 4/4/1xT2 1000V	GAK 4/4/1xT1+T2 800V	GAK 4/4/1xT1+T2 1000V
Article-No.	80 01 00	80 01 02	80 01 04	80 01 06
Max. system voltage	800 V=	1000 V=	800 V=	1000 V=
Max. current per input terminal (+)	57 A	57 A	57 A	57 A
Max. current per output terminal	57 A	57 A	57 A	57 A
Operating temperature range	TU -40 - +80 °C	-40 - +80 °C	-40 - +80 °C	-40 - +80 °C
Cross section for E-terminals (input)	16 mm ²	16 mm ²	16 mm ²	16 mm ²
Cross section for A-terminals (output)	16mm ² single wire. / stranded	16mm ² single wire. / stranded	16mm ² single wire. / stranded	16mm ² single wire. / stranded
Cable feedthrough	10x M20	10x M20	10x M20	10x M20
Degree of protection (IEC EN 60529)	IP 66	IP 66	IP 66	IP 66
Dimensions of housing (H x W x D)	300 x 200 x 132 mm	300 x 200 x 132 mm	300 x 200 x 132 mm	300 x 200 x 132 mm
SPD acc. to IEC 61643-11	Type 2 / class II	Type 2 / class II	Type 1 + 2 / class I + II	Type 1 + 2 / class I + II

Dimension drawing, see pages 194 to 198



GENERATOR CONNECTION BOXES GAK WITHOUT STRING FUSES





GAK 8/8

Generator connection box with 22 terminal points. The connected plus and minus pol terminals for the input and output strings are free selectable. Take attention to manufacturer's requirement about the maximum reverse current in any parallel connection of solar panels.



Example image

- Housing of surface mounting (300 x 200 x 132 mm) / IP66
- 22 terminal points are arbitrary: e. g. 11x input terminal and 11x output terminal
- One arrester 800 or 1000 V, T2 or T1+ T2
- Variants with remote signalling contact also available (on request)
- Terminals can be used as points of measurement

				
Technical Data	GAK 8/8/1xT2 800V	GAK 8/8/1xT2 1000V	GAK 8/8/1xT1+T2 800V	GAK 8/8/1xT1+T2 1000V
Article-No.	80 01 10	80 01 12	80 01 14	80 01 16
Max. system voltage	800 V=	1000 V=	800 V=	1000 V=
Max. current per input terminal (+)	57 A	57 A	57 A	57 A
Max. current per output terminal	57 A	57 A	57 A	57 A
Operating temperature range	TU -40 - +80 °C	-40 - + 80 °C	-40 - + 80 °C	-40 - + 80 °C
Cross section for E-terminals (input)	16 mm ²	16 mm ²	16 mm ²	16 mm ²
Cross section for A-terminals (output)	16mm ² single wire. / stranded	16mm ² single wire. / stranded	16mm ² single wire. / stranded	16mm ² single wire. / stranded
Cable feedthrough	18x M20	18x M20	18x M20	18x M20
Degree of protection (IEC EN 60529)	IP 66	IP 66	IP 66	IP 66
Dimensions of housing (H x W x D)	300 x 200 x 132 mm	300 x 200 x 132 mm	300 x 200 x 132 mm	300 x 200 x 132 mm
SPD acc. to IEC 61643-11	Type 2 / class II	Type2 / class II	Type 1 + 2 / class I + II	Type 1 + 2 / class I + II

Dimension drawing, see pages 194 to 198





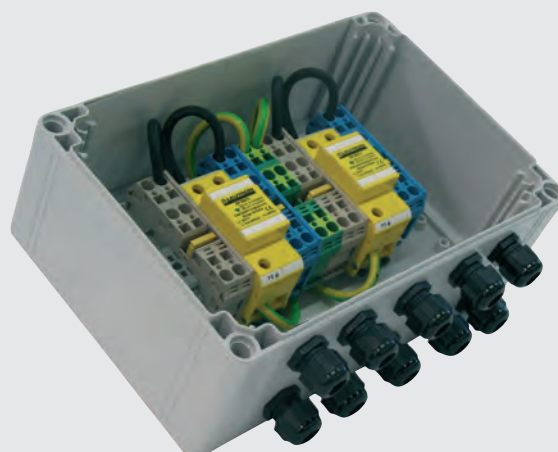

GAK 2+2

Generator connection box for maximum 2x five terminal points for two MPP tracker.
Application: to protect inverter with two MPP trackers or two inverter with each one MPP tracker.
Take attention to manufacturer's requirement about the maximum reverse current in any parallel connection of solar panels.



Example image

- Housing of surface mounting (300 x 200 x 132 mm) / IP66
- 2x 5 terminal points (e. g. 2x 2 input terminal and 2x 2 output terminal)
- Two arrester 800 or 1000 V, T2 or T1+ T2
- Variants with remote signalling contact also available (on request)
- Terminals can be used as points of measurement

				
Technical Data	GAK 2+2/2+2/2xT2 800V	GAK 2+2/2+2/2xT2 1000V	GAK 2+2/2+2/2xT1+T2 800V	GAK 2+2/2+2/2xT1+T2 1000V
Article-No.	80 01 20	80 01 22	80 01 24	80 01 26
Max. system voltage	800 V=	1000 V=	800 V=	1000 V=
Max. current per input terminal (+)	57 A	57 A	57 A	57 A
Max. current per output terminal	57 A	57 A	57 A	57 A
Operating temperature range	TU -40 - +80 °C	-40 - +80 °C	-40 - +80 °C	-40 - +80 °C
Cross section for E-terminals (input)	16 mm ²	16 mm ²	16 mm ²	16 mm ²
Cross section for A-terminals (output)	16mm ² single wire. / stranded	16mm ² single wire. / stranded	16mm ² single wire. / stranded	16mm ² single wire. / stranded
Cable feedthrough	10x M20	10x M20	10x M20	10x M20
Degree of protection (IEC EN 60529)	IP 66	IP 66	IP 66	IP 66
Dimensions of housing (H x W x D)	300 x 200 x 132 mm	132 x 200 x 300 mm	132 x 200 x 300 mm	132 x 200 x 300 mm
SPD acc. to IEC 61643-11	Type 2 / class II	Type 2 / class II	Type 1 + 2 / class I + II	Type 1 + 2 / class I + II

	
Technical Data	PV DC 2.800-2
Article-No.	80 00 26
Max. system voltage	800 V=
Max. current per input terminal (+)	57 A
Max. current per output terminal	57 A
Operating temperature range	TU -40 - +80 °C
Cross section for E-terminals (input)	16 mm ²
Cross section for A-terminals (output)	16mm ² single wire. / stranded
Cable feedthrough	9x M16
Degree of protection (IEC EN 60529)	IP 66
Dimensions of housing (H x W x D) /weight	132 x 200 x 300 mm / 3,0 kg
SPD acc. to IEC 61643-11	Type 1 + 2 / class I + II

Dimension drawing, see pages 194 to 198



GENERATOR CONNECTION BOXES GAK WITHOUT STRING FUSES

GAK 3+3

Generator connection box for maximum two times of seven terminal points. Strings for two MPP-Tracker.

Application: to protect inverter with two MPP trackers or two inverters with each one MPP tracker.



Example image

- 2x 7 Terminal points are arbitrary (e. g. 2x 3 input terminal and 2x 3 output terminal)
- Two arresters: 800 up to 1000 V, T2 or T1+ T2 or both combined
- Variants with remote signalling contact also available (on request)
- Terminals can be used as points of measurement

				
Technical Data	GAK 3+3/3+3/2xT1+T2 800V	GAK 3+3/3+3/3/2xT1+T2 1000V	GAK 3+3/3+3+3/2xT1+T2 800V/1000V	GAK 3+3/2xT1+T2 1000 V
Article-No.	80 01 25	80 01 27	80 01 28	80 01 68
Max. system voltage	800 V=	1000 V=	800/1000 V=	1000 V=
Max. current per input terminal (+)	57 A	57 A	57 A	57 A
Max. current per output terminal	57 A	57 A	57 A	57 A
Operating temperature range	TU -40 - +80 °C	-40 - +80 °C	-40 - +80 °C	-40 - +80 °C
Cross section for E-terminals (input)	16 flex. mm ²	16 flex. mm ²	16 flex. mm ²	16 flex. mm ²
Cross section for A-terminals (output)	16mm ² single wire. / stranded	16mm ² single wire. / stranded	16mm ² single wire / stranded	16mm ² single wire / stranded
Cable feedthrough	10x M20	13x M20	10x M20	10x M20
Degree of protection (IEC EN 60529)	IP 66	IP 66	IP 66	IP 66
Installation dimensions (W × H × D)	300 x 200 x 132 mm	400 x 200 x 132 mm	300 x 200 x 132 mm	300 x 200 x 132 mm
SPD acc. to EN 61643-11	Type 1 + 2 / class I + II	Type 1 + 2 / class I + II	Type 1 + 2 / class I + II	Type 1 + 2 / class I + II

Dimension drawing, see pages 194 to 198





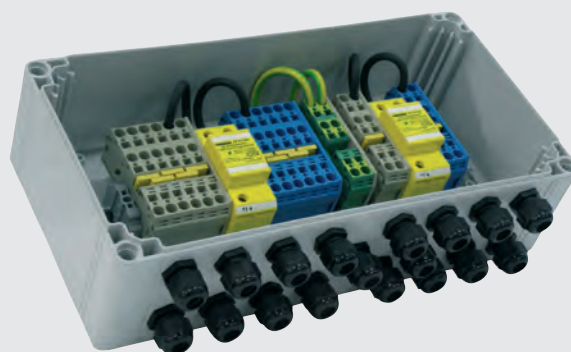

GAK 6+2

Generator connection box for 1x 17 + 1x 5 terminal points for two MPP tracker.
Application: to protect inverter with two MPP trackers and asynchronous power parts (e. g. SMA Tripower WR)

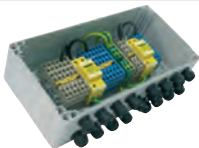

Example image

- Housing of surface mounting (400 x 200 x 132 mm) / IP66
- 1x 17 + 1x 5 terminal points are arbitrary (e. g. 1x 6 Input terminal and 1x 6 output terminal for power part A and 1x 2 input terminal with 1x 2 output terminal für power part B)
- Two arrester either 800 V or 1000 V, SPD type 2 or type 1+2 (depends on application)
- Variants with remote signalling contact also available (on request)
- Terminals can be used as points of measurement

				
Technical Data	GAK 6+2/6+2/2xT2 800V	GAK 6+2/6+2/2xT2 1000V	GAK 6+2/6+2/2xT1+T2 800V	GAK 6+2/6+2/2xT1+T2 1000V
Article-No.	80 01 30	80 01 32	80 01 34	80 01 36
Max. system voltage	800 V=	1000 V=	800 V=	1000 V=
Max. current per input terminal (+)	57 A	57 A	57 A	57 A
Max. current per output terminal	57 A	57 A	57 A	57 A
Operating temperature range	TU -40 - +80 °C	-40 - +80 °C	-40 - +80 °C	-40 - +80 °C
Cross section for E-terminals (input)	16 mm ²	16 mm ²	16 mm ²	16 mm ²
Cross section for A-terminals (output)	16mm ² single wire. / stranded	16mm ² single wire. / stranded	16mm ² single wire. / stranded	16mm ² single wire. / stranded
Cable feedthrough	18x M20	18x M20	18x M20	18x M20
Degree of protection (IEC EN 60529)	IP 66	IP 66	IP 66	IP 66
Dimensions of housing (H x W x D)	132 x 200 x 400 mm	132 x 200 x 400 mm	132 x 200 x 400 mm	132 x 200 x 400 mm
SPD acc. to EN 61643-11	Type 2 / class II	Type 2 / class II	Type 1 + 2 / class I + II	Type 1 + 2 / class I + II

Dimension drawing, see pages 194 to 198



GENERATOR CONNECTION BOXES GAK WITHOUT STRING FUSES

GAK 4+4+4

Generator connection box for 3x 11 terminal points for three MPP tracker.
Application: in PV systems; to protect the inverter with three MPP tracker or three single inverter.

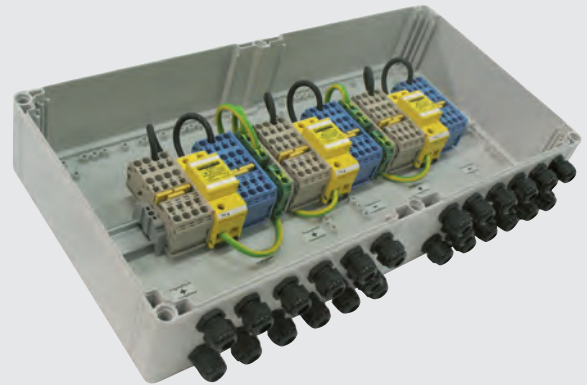

Example image

- Housing of surface mounting (600 x 300 x 132 mm) / IP66
- 3x 11 Terminal points are arbitrary (e. g. 3x 5 input terminals and 3x 5 output terminals)
- Three arrester either 800 or 1000 V, type 2 or type 1+ 2 (depends on application)
- Variants with remote signalling contact also available (on request)
- Terminals can be used as points of measurement

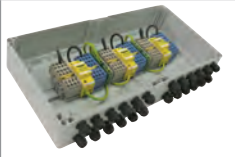
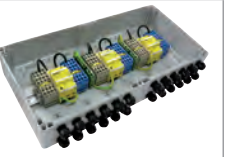
				
Technical Data	GAK 4+4+4/4+4+4/3xT2 800V	GAK 4+4+4/4+4+4/3xT2 1000V	GAK 4+4+4/4+4+4/3xT1+T2 800V	GAK 4+4+4/4+4+4/3xT1+T2 1000V
Article-No.	80 01 40	80 01 42	80 01 44	80 01 46
Max. system voltage	800 V=	1000 V=	800 V=	1000 V=
Max. current per input terminal (+)	57 A	57 A	57 A	57 A
Max. current per output terminal	57 A	57 A	57 A	57 A
Operating temperature range	TU -40 - +80 °C	-40 - +80 °C	-40 - +80 °C	-40 - +80 °C
Cross section for E-terminals (input)	16 mm ²	16 mm ²	16 mm ²	16 mm ²
Cross section for A-terminals (output)	16mm ² single wire. / stranded	16mm ² single wire. / stranded	16mm ² single wire. / stranded	16mm ² single wire. / stranded
Cable feedthrough	26x M20	26x M20	26x M20	26x M20
Degree of protection (IEC EN 60529)	IP 66	IP 66	IP 66	IP 66
Dimensions of housing (H x W x D)	132 x 200 x 600 mm	132 x 200 x 600 mm	132 x 200 x 600 mm	132 x 200 x 600 mm
SPD acc. to EN 61643-11	Type 2 / class II	Type 2 / class II	Type 1 + 2 / class I + II	Type 1 + 2 / class I + II

Dimension drawing, see pages 194 to 198



GAK 3x1 / GAK 6x1 / GAK 8x2 / GAK 9x1



Generator Connection Boxes for middle or big sized PV systems. They are free combinable and for high generator power.

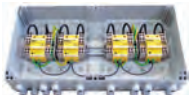

Example image

- Housing of surface mounting are UV resistant / IP 66
- Terminals can be used as points of measurement
- Remote signal contacts are connected for use
- Variants with remote signalling contact also available (on request)

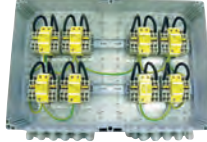
				
Technical Data	PV DC 3.800-3-S2	PV DC 3.800-3	GAK 3x1/3x1/3xT1+2 1000V	GAK 4x3/4xT1+T2 1000V-FM
Article-No.	80 00 43	80 00 39	80 01 48	80 01 64
Max. system voltage	800 V=	800 V=	1000 V=	1000 V=
Max. current per input terminal (+)	76 A	76 A	76 A	57 A
Max. current per output terminal	76 A	76 A	76 A	57 A
Operating temperature range	TU -40 - +80 °C	-40 - +80 °C	-40 - + 80 °C	-40 - + 80 °C
Cross section for E-terminals (input)	16 mm ²	16 mm ²	16 mm ²	16 mm ²
Cross section for A-terminals (output)	16 mm ²	16 mm ²	16mm ²	16mm ²
Cable feedthrough	13x M16	13x M16	13x M16	26x M20
Degree of protection (IEC EN 60529)	IP 66	IP 66	IP 66	IP 66
Dimensions (L x W x H)	200 x 400 x132 mm	200 x 400 x132 mm	200 x 400 x 132 mm	200 x 600 x 132 mm
SPD acc. to EN 61643-11	Type 1 + 2 / class I + II	Type 2 / class II	Type 1 + 2 / class I + II	Type 1 + 2 / class I + II

				
Technical Data	GAK 6x1/6x1/6x T1+T2 1000V	PV DC 8.800-8	GAK 8x2/8x2/8x T1+T2 1000V-FM	GAK 9x1/9x1/9x T1+T2 1000V
Article-No.	80 01 49	80 00 56	80 01 56	80 01 50
Max. system voltage	1000 V=	800 V=	1000 V=	1000 V=
Max. current per input terminal (+)	76 A	76 A	57 A	76 A
Max. current per output terminal	76 A	76 A	57 A	76 A
Operating temperature range	TU -40 - +80 °C	-40- +80 °C	-40 - +80 °C	-40 - +80 °C
Cross section for E-terminals (input)	16 mm ²	16 mm ²	16 mm ²	16 mm ²
Cross section for A-terminals (output)	16 mm ² flex.	16 mm ² flex.	16 mm ² flex.	16 mm ² flex.
Cable feedthrough	25x M16	33x M16	24x M20 / 13x M16	37x M16
Installation dimensions (W x H x D) /Gewicht	600 x 400 x 132 mm	400 x 600 x 132 mm / 6,0 kg	600 x 400 x 132 mm / 6,5 kg	600 x 400 x 132 mm/ 6,5 kg
Degree of protection (IEC EN 60529)	IP 66	IP 66	IP 66	IP 66
SPD acc. to EN 61643-11	Type 1 + 2 / class I + II	Type 1 + 2 / class I + II	Type 1 + 2 / class I + II	Type 1 + 2 / class I + II

Dimension drawing, see pages 194 to 198



GENERATOR CONNECTION BOXES GAK WITHOUT STRING FUSES

PV DC 2X2/PV DC 2x3 1000V/30A



Generator connection box without surge protection.

Application: in PV systems; Stringbox to protect the inverter with two MPP trackers or four terminals per plus and minus pole each.



Example image

- Housing of surface mounting (200 x 200 x 132 mm) / IP66

		
Technical Data	PV DC 2x2 1000V/30A	PV DC 2x3 1000V/30A
Article-No.	80 01 67	80 01 69
Max. system voltage	1000 V=	1000 V=
Max. current per input terminal (+)	30 A	30 A
Max. current per output terminal	30 A	30 A
Operating temperature range	TU -50 - +120 °C	-50 - +120 °C
Cross section for E-terminals (input)	16 mm ²	16 mm ²
Cross section for A-terminals (output)	16mm ² single wire. / stranded	16mm ² single wire. / stranded
Cable feedthrough	12x M16	12x M16
Degree of protection (IEC EN 60529)	IP 66	IP 66
Dimensions of housing (H x W x D)	132 x 200 x 200 mm	132 x 200 x 200 mm
SPD acc. to EN 61643-11	without	without

Dimension drawing, see pages 194 to 198

GAK AC

Generator connection box for threephase TNS system.

Application: e. g. at PV systems to protect the AC side of the inverter.



Example image

- Housing of surface mounting (300 x 200 x 132 mm) / IP66
- Four pole SPD PP BC TNS 25/100 including
- Variant with remote signalling contact also available (on request)

	
Technical Data	GAK AC-3 T1+T2
Article-No.	80 01 57
Cross section for E-terminals (input)	16 mm ²
Cross section for A-terminals (output)	16mm ² single wire. / stranded
Cable feedthrough	2x M25/1x M20
Degree of protection (IEC EN 60529)	IP 66
Installation dimensions (W × H × D)	300 x 200 x 132 mm
Weight	3,1 kg
SPD acc. to EN 61643-11	Type 1 + 2 / class I + II
Nominal alternating voltage UN	230/400 V~
Max. continuous operating voltage AC Uc	255 V~
Insulation resistance Risol	> 10 GΩ
Protection level at 100% lightn. imp. sparkover voltage (1.2/50μs) Up	≤ 2,5 kV
Protection level at limp L-PE Up	≤ 2,5 kV
Lightning impulse current (10/350) L1+L2+L3+N-PE Itotal	100 kA
Lightning impulse current (10/350) L,N-PE Iimp	25 kA
Follow-on current extinguishing capability at Uc (50/60 Hz) I _{fi}	4 kA
Short-circuit withstand capability at max. back-up fuse I _k	50 kA _{eff}
Operating temperature range TU	-40 - +80 °C
Max. acceptable back-up fuse F2 (spur wiring)	250 A gL/gG

Dimension drawing, see pages 194 to 198



GENERATOR CONNECTION BOXES COMPLETE PROTECTION OF INVERTER



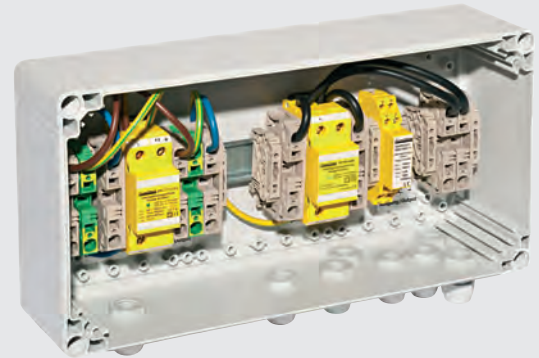

PV AC-DC

Complet overvoltage protection for inverters.
Mounting it directly nearby inverter is advantageous.



Example image

- AC side: SPD Type 2
- DC side: Combined arrester Type 1 + Type 2
- Signal line and data line:
IEC category C1/C2/C3

				
Technical Data	PV AC-DC 1.1-800	PV AC-DC 3.1-1000	PV AC-DC 1.1-1000	PV AC-DC 1.2-800
Article-No.	80 00 31	80 00 32	80 00 33	80 00 34
Max. system voltage	800 V=	1000 V=	1000 V=	800 V=
Max. current per input terminal (+)	76 A	76 A	76 A	76 A
Max. current per output terminal	30 A	30 A	30 A	30 A
Operating temperature range	TU -40 - +80 °C	-40 - +80 °C	-40 - +80 °C	-40 - +80 °C
Cross section for E-terminals (input)	16 mm ²	16 mm ²	16 mm ²	16 mm ²
Cross section for A-terminals (output)	16 mm ² flex.	16 mm ² flex.	16 mm ² flex.	16 mm ² flex.
Cable feedthrough	8x M20	8x M20	8x M20	8x M20
Degree of protection (IEC EN 60529)	IP 66	IP 66	IP 66	IP 66
Installation dimensions (W × H × D)	200 x 400 x 132 mm	200 x 400 x 132 mm	200 x 400 x 132 mm	200 x 400 x 132 mm

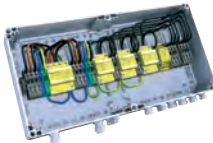
	
Technical Data	PV AC-DC 3.3-1000
Article-No.	80 00 35
Max. system voltage	1000 V=
Max. current per input terminal (+)	76 A
Max. current per output terminal	30 A
Operating temperature range	TU -40 - +80 °C
Cross section for E-terminals (input)	16 mm ²
Cross section for A-terminals (output)	16 mm ² flex.
Cable feedthrough	8x M20
Degree of protection (IEC EN 60529)	IP 66
Installation dimensions (W × H × D)	300 x 600 x 132 mm

Dimension drawing, see pages 194 to 198



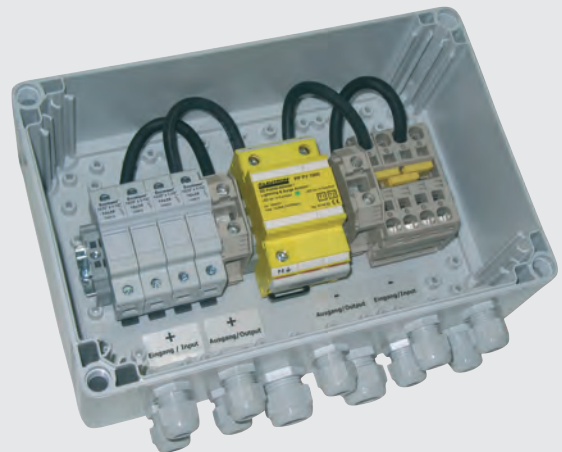

PV DC 4 / PV DC 9 / PV DC 12

Generator connection boxes with fuse holder for dc string fuses (dimensions: 10 x 38 mm).
Therewith single modul strings can be fixed together to satisfy requirements (max. reverse current) of producers of the moduls.







Example image

			
Technical Data	PV DC 4	PV DC 4.1000-2	PV DC 5.1000 T1+T2
Article-No.	80 01 01	80 00 27	80 01 65
Max. system voltage	1000 V=	1000 V=	1000 V=
Max. current per input terminal (+)	30 A	30 A	30 A
Max. current per output terminal	125 A	125 A	125 A
String fuse	4x 15 A	4x 15 A	5x 15 A
Operating temperature range	TU -50 - +120 °C	-40 - +80 °C	-40 - +80 °C
Cross section for E-terminals (input)	16 mm ²	16 mm ²	16 mm ²
Cross section for A-terminals (output)	35 mm ² flex.	35 mm ² flex.	35 mm ² flex.
Cable feedthrough	8x M16 / 2x M25	9x M16 / 2x M25	9x M16 / 2x M25
Degree of protection (IEC EN 60529)	IP 66	IP 66	IP 66
Installation dimensions (W x H x D)	200 x 300 x 132 mm	200 x 300 x 132 mm	200 x 300 x 132 mm
SPD acc. to EN 61643-11	without	Type 1 + 2 / class I + II	Type 1 + 2 / class I + II

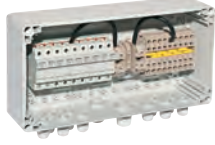

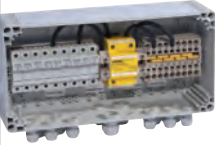
GENERATOR CONNECTION BOXES GAK WITH REVERSE CURRENT FUSE

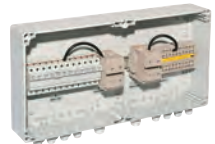
			
Technical Data	PV DC 9	PV DC 9.800	PV DC 9.1000
Article-No.	80 01 71	80 00 28	80 00 29
Max. system voltage	1000 V=	800 V=	1000 V=
Max. current per input terminal (+)	30 A	30 A	30 A
Max. current per output terminal	125 A	125 A	125 A
String fuse	9x 15 A	9x 15 A	9x 15 A
Operating temperature range	TU -50 - +120 °C	-40 - +80 °C	-40 - +80 °C
Cross section for E-terminals (input)	16 mm ²	16 mm ²	16 mm ²
Cross section for A-terminals (output)	35 mm ² flex.	35 mm ²	35 mm ²
Cable feedthrough	18x M16 / 2x M25	19x M16 / 2x M25	19x M16 / 2x M25
Degree of protection (IEC EN 60529)	IP 66	IP 66	IP 66
Installation dimensions (W × H × D)	200 x 400 x 132 mm	200 x 400 x 132 mm	200 x 400 x 132 mm
SPD acc. to EN 61643-11	without	Type 1 + 2 / class I + II	Type 1 + 2 / class I + II

			
Technical Data	PV DC 12	PV DC 12.800-2	PV DC 12.1000-2
Article-No.	80 01 70	80 00 23	80 00 30
Max. system voltage	1000 V=	800 V=	1000 V=
Max. current per input terminal (+)	30 A	30 A	30 A
Max. current per output terminal	220 A	220 A	220 A
String fuse	12x 15 A	12x 15 A	12x 15 A
Operating temperature range	TU -50 - +120 °C	-40 - +80 °C	-40 - +80 °C
Cross section for E-terminals (input)	16 mm ²	16 mm ²	16 mm ²
Cross section for A-terminals (output)	120 mm ² flex.	120 mm ² flex.	120 mm ² flex.
Cable feedthrough	25x M16 / 4x M25	25x M16 / 4x M25	25x M16 / 4x M25
Degree of protection (IEC EN 60529)	IP 66	IP 66	IP 66
Installation dimensions (W × H × D)	300 x 600 x 132 mm	300 x 600 x 132 mm	300 x 600 x 132 mm
SPD acc. to EN 61643-11	without	Type 1 + 2 / class I + II	Type 1 + 2 / class I + II

Dimension drawing, see pages 194 to 198



GAK 4+1

Generator connection box for maximum four plus one entry and one exit per arrester.

Application: For protection of inverter with two MPP trackers or two inverters with each one MPP tracker.

- Housing of surface mounting (400 x 200 x 132 mm) / IP66
- Input / Output: Parallel connection of four strings for one arrester and one string for a second MPP tracker or further inverters
- Two combined arrester type 1+type 2 with 1000 V
- For holding of dc string fuses (dimension 10 x 38 mm)
- For asynchronous circuits, e. g. SMA Tripower



Technical Data	
Article-No.	GAK 4+1/2xT1+T2 1000V 80 01 55
Max. system voltage	1000 V=
Max. current per input terminal (+)	30 A
Max. current per output terminal	125 A
Operating temperature range	TU -40 - +80 °C
Cross section for E-terminals (input)	16 mm ²
Cross section for A-terminals (output)	16mm ² single wire. / stranded
Cable feedthrough	11x M16 / 4x M25
Degree of protection (IEC EN 60529)	IP 65
Installation dimensions (W x H x D)	400 x 200 x 132 mm
SPD acc. to EN 61643-11	Type 1 + 2 / class I + II

SPECIAL EDITION GAK

PV DC 1/1

Generator connection box for maximum one string for one MPP tracker. For connection with MC4 connectors. Application: to protect inverter with one MPP tracker in PV systems.

- Housing of surface mounting (200 x 200 x 132 mm) / IP66
- Input / Output: one string for plus and one for minus
- Fitted with one SPD type 1+ 2 (class I+II)





Technical Data	
Article-No.	PV DC 1/1 1xT1+2 1000V/MC4 80 00 92
Max. system voltage	1000 V=
Max. nominal current per MC4 connector	30 A
Max. nominal current per MC4 connector	30 A
Operating temperature range	TU -40 - +80 °C
Cable feedthrough	1x M16 / 4x MC4
Degree of protection (IEC EN 60529)	IP 66
Dimensions (L x W x H)	200 x 200 x 132 mm
SPD acc. to EN 61643-11	Type 1 + 2 / class I + II

Dimension drawing, see pages 194 to 198



String diodes

String diodes for PV module: The diode is covered with EVA (Ethylenvinylacetat) and with PV line irreversible connected.

		
Technical Data	ST-D 1200	ST-D 1200-500
Article-No.	17 01 20	17 01 21
Nominal current	IL 10 A	10 A
Repetitive peak off-state voltage	1200 V	1200 V
peak off-state voltage	1200 V	1200 V
limiting average on state current	10 A	10 A
Length of connection	400 mm	500 mm







Air-rating plug

Ventilation device, with membran to ventilate the generator connection box in an optimal way.

	
Technical Data	E-Membran M12
Article-No.	17 01 40
Dimension	Ø 19 x 17 mm
Membran material	Acrylicco-polymer on nylon support
Protection degree	IP 69
Working temperatures	-40° to +105°C
Recommended tightening torque	0.5 - 1.0 Nm

String fuses

String fuses for PV modules:

							
Technical Data	ST-Si/2A	ST-Si/4A	ST-Si/8A	ST-Si/10A	ST-Si/12A	ST-Si/15A	ST-Si/20A
Article-No.	17 01 50	17 01 51	17 01 52	17 01 53	17 01 54	17 01 55	17 01 56
Rated current	2 A	4 A	8 A	10 A	12 A	15 A	20 A
Rated voltage	1000 V _{AC/DC}	1000 V _{AC/DC}	1000 V _{AC/DC}	1000 V _{AC/DC}	1000 V _{AC/DC}	1000 V _{AC/DC}	1000 V _{AC/DC}
Dimension	10 x 38 mm	10 x 38 mm	10 x 38 mm	10 x 38 mm	10 x 38 mm	10 x 38 mm	10 x 38 mm
piece/unit	10	10	10	10	10	10	10

DAK 2x 16

Pin-shaped terminal to enable feed-through wiring (V-wiring) for all surge protection modules with only one clamp per phase, such as PP PV 800 and 1000 and other SPDs for power supply systems.

- Looped-in wiring for SPD with only one connection terminal
- Connection of 2 lines at only one terminal possible
- Connection of max. 2x 16 mm² fine-stranded
- Conformed by standard looped-in wiring (V connected)
- Acc. to DIN VDE 0100-534

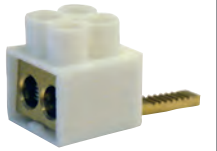
	
Technical Data	DAK 2x 16
Article-No.	17 01 10
Type of connection	front: double terminal, back: connection
Conductor cross section	2x 16 mm ²
Dimension (L x B x H)	17 x 38,5 x 21 mm

Dimension drawing, see pages 194 to 198

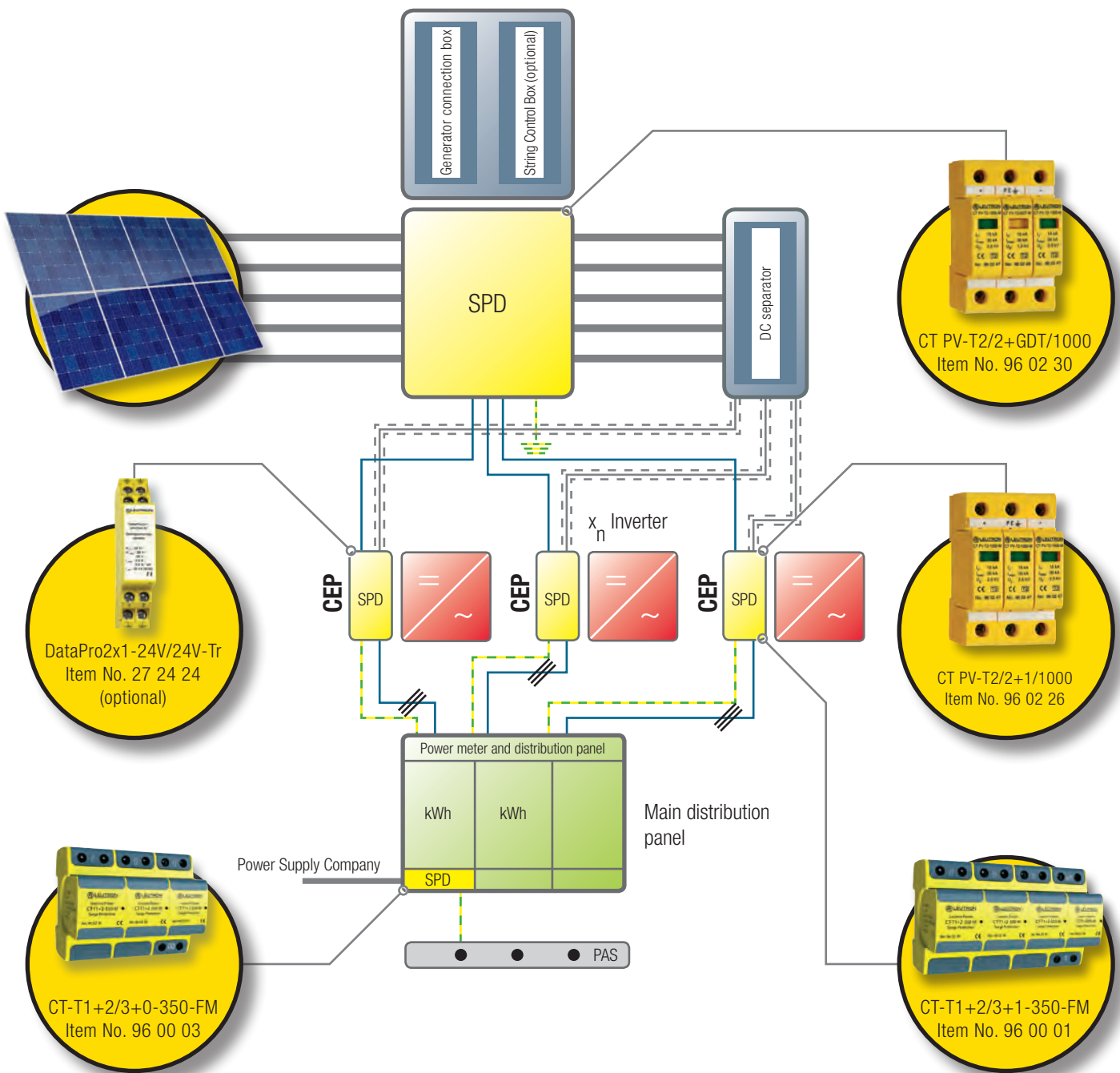

In addition to the modules, the photovoltaic system is also integrated into the building's electrical systems, which are necessarily vulnerable to direct or indirect lightning strikes. Lightning strikes and power surges have serious consequences: aside from production losses, there are also high repair costs - Costs that Leutron can keep down.

CEP: Central Entry Point

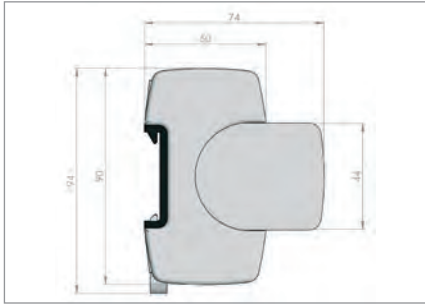

CT product line

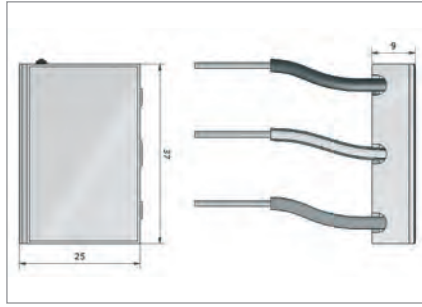

EnerPro D 230 KM

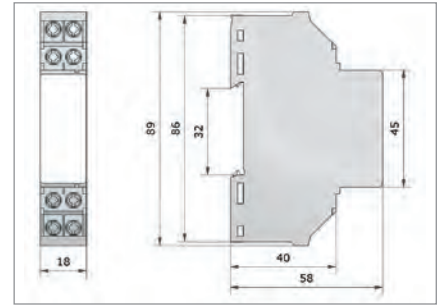

EnerPro V-Tr

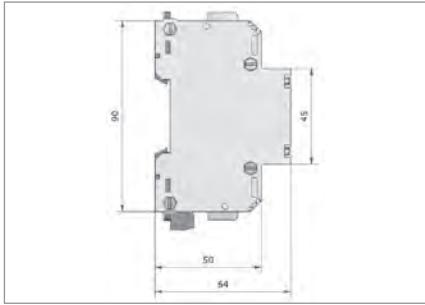

PowerPro/IsoPro

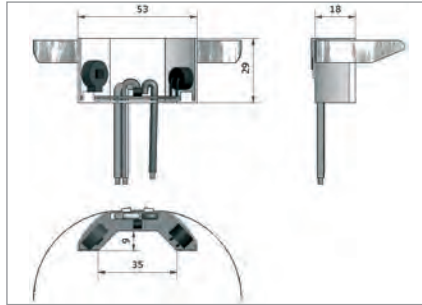

EnerPro 230 SDU

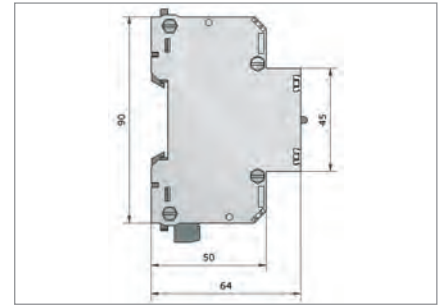

PP PV 800 and PP PV 1000

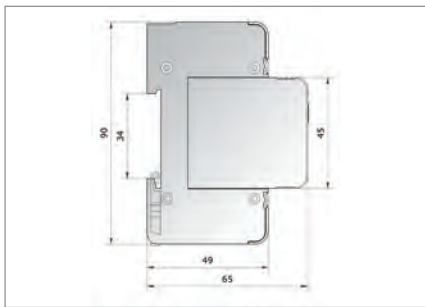

EL product line

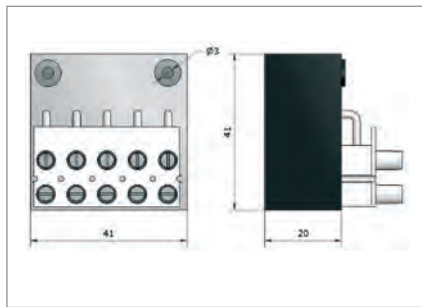

NM 220V/5kA and NM 220V/20kA

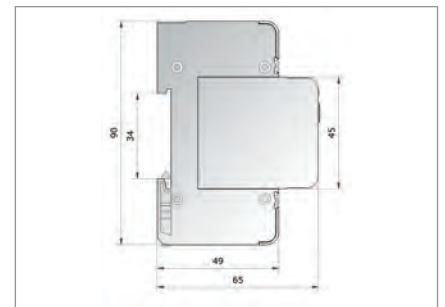

CT PV product line

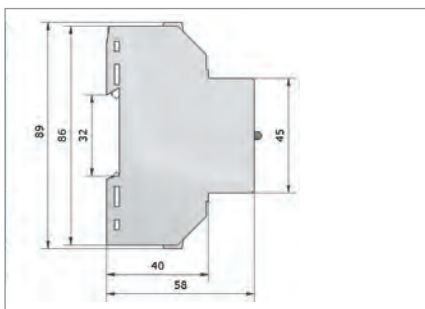

EnerPro D

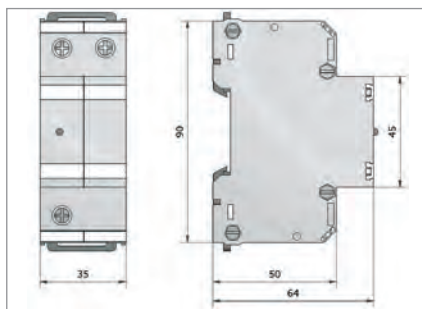

EnerPro 48V/100A-Tr

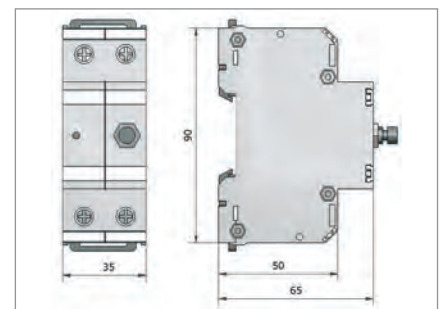

UAS 230-Tr

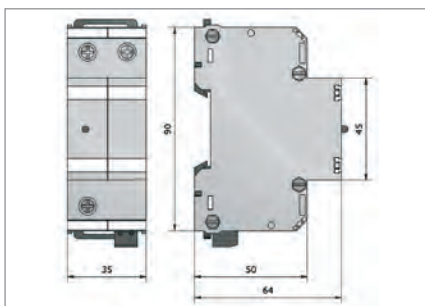

EnerPro 150Tr/Pk

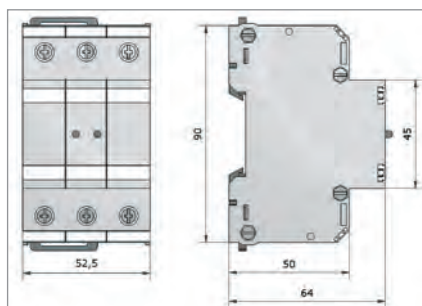

EnerPro 6A LED

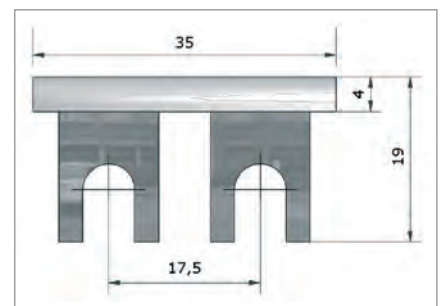

Busbar KA

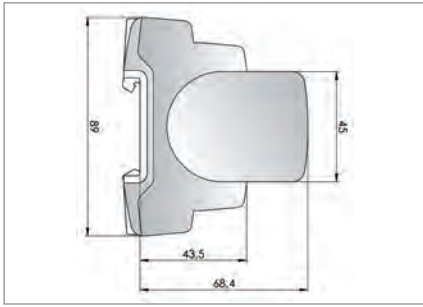

MP product line

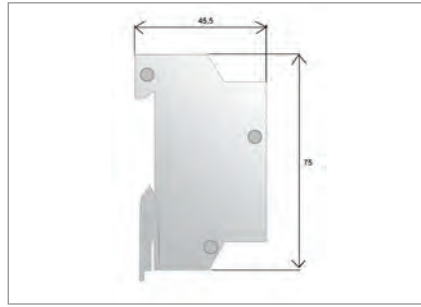

DataPro RJ45-CAT6

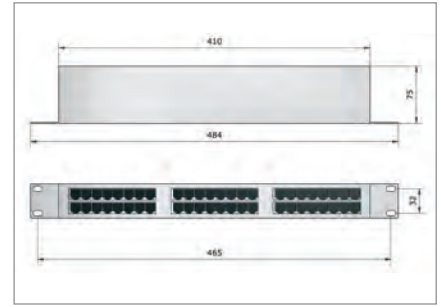

DataPro 4x8 bis 6x8RJ45-19"

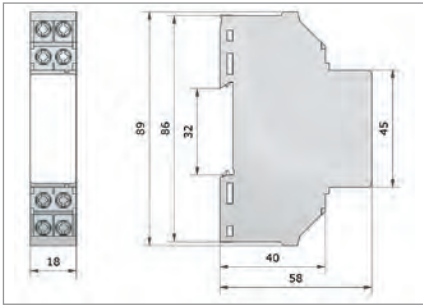

DataPro2x1-SDSL-Tr



DataPro-RJ45-48V-Tr



DataPro 8xRJ45-6V-WG

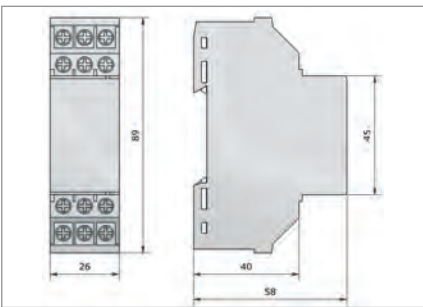

DataPro4x1-SDSL-Tr

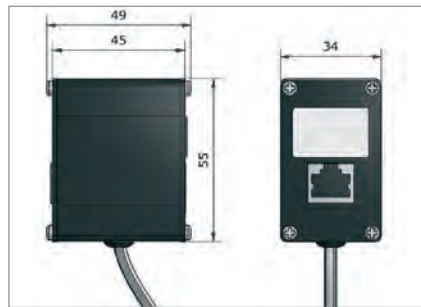

DataPro-1xRJ45PoE-Alu

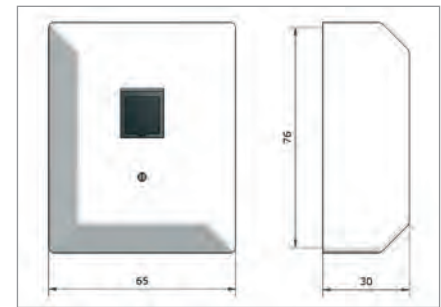

DataPro ISDN-aP

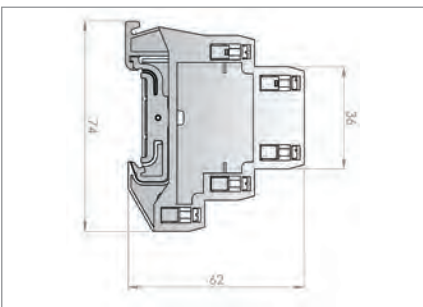

MP RK product line

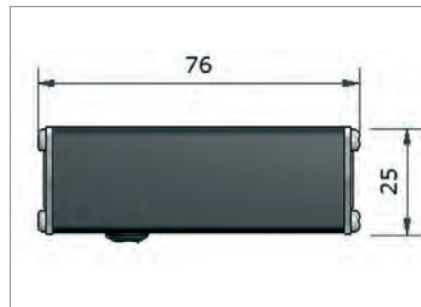

DataPro RJ45 f/f

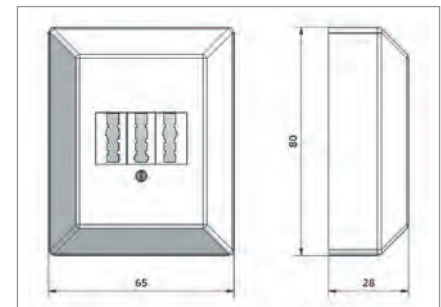

DataPro-TAE/NFN-aP

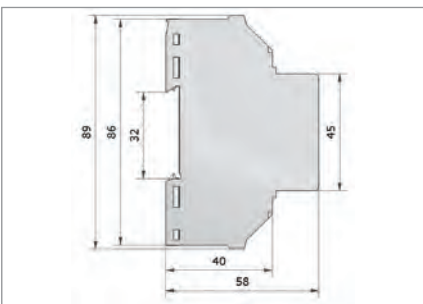

IsoProData-Tr

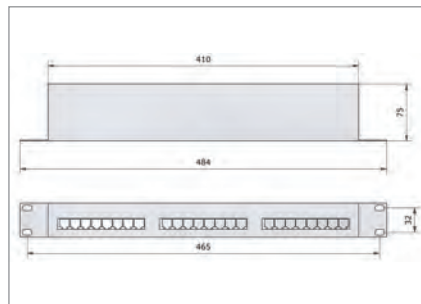

DataPro 1x8 bis 3x8RJ45-19"

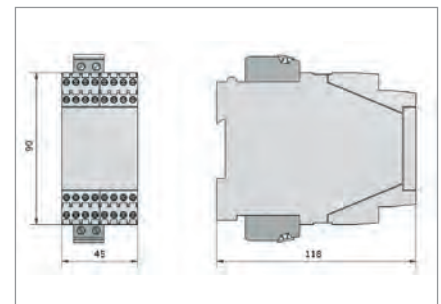

DataPro2x8 36V/36V-Tr/GO

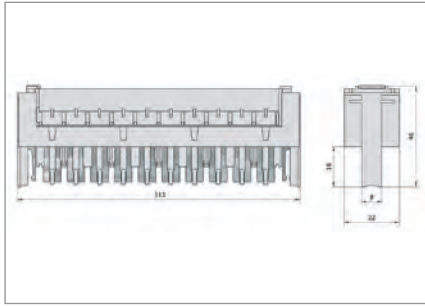

TelPro LSA – SSCT magazines

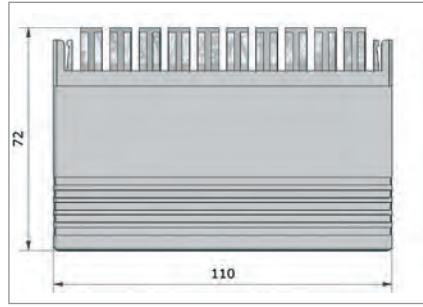

DataPro 10LSA (10 SSCT)

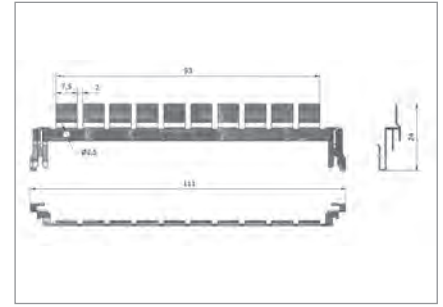

SSCT ground bar

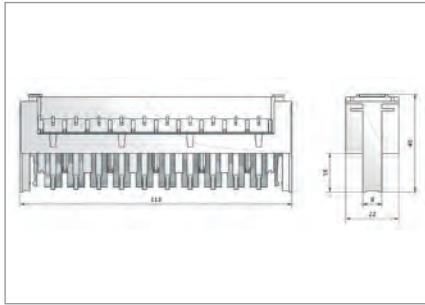

TelPro LSA – SSCT magazines

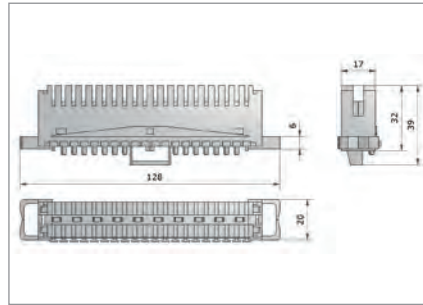

SSCT disconnection module LSA 2/10-TR

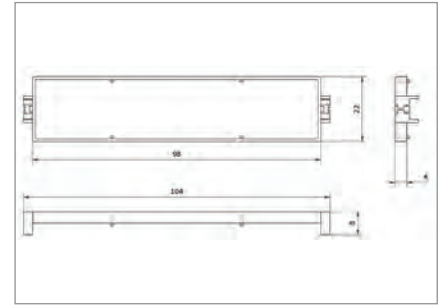

SSCT magazine cover

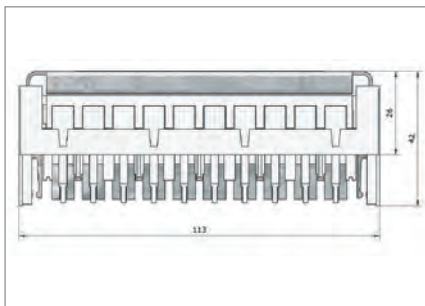

TelPro LSA – SSCT magazines

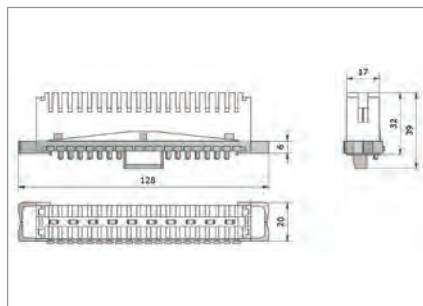

SSCT connection module LSA 2/10-AN

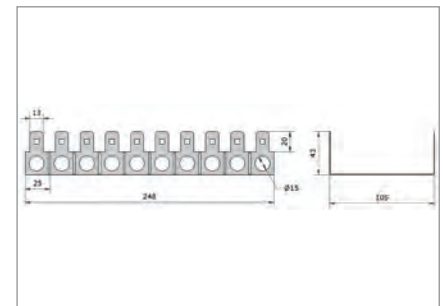

SSCT backmount frame

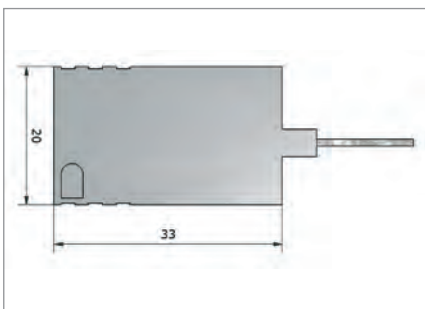

LSA – SSCT Connector fine and coarse protection

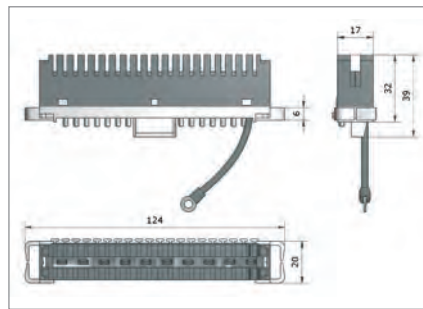

SSCT ground module LSA 2/10-ER38-rot

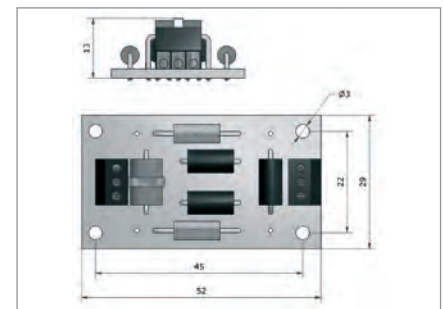

DataPro Z

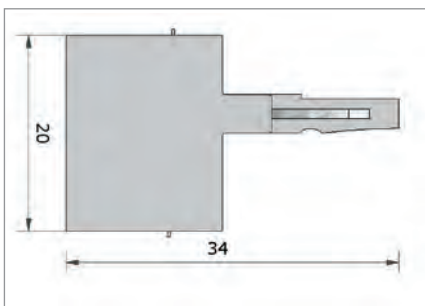

LSA – SSCT Connector coarse protection

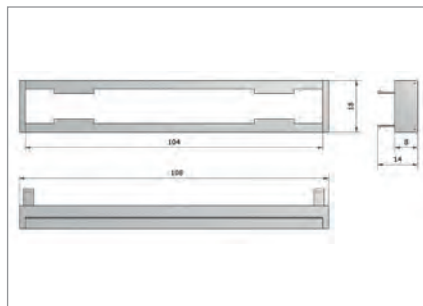

LSA – SSCT frame

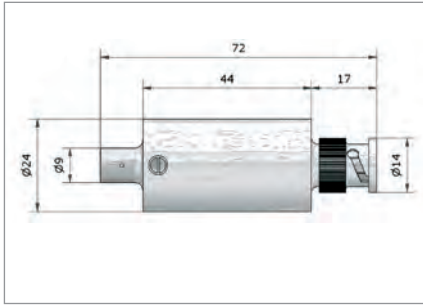

DataPro Koax-8V-BNC

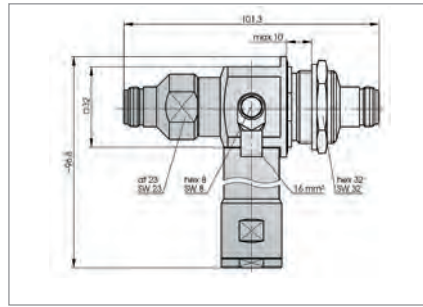

AntPro Lambda/4 N 0.51GHz (f/f)

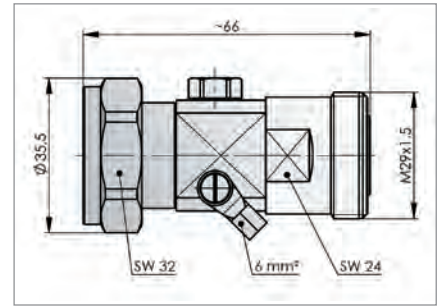

DataPro Koax 7/16

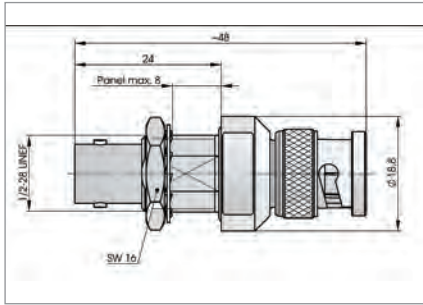

DataPro KOax BNC 50 Ohm

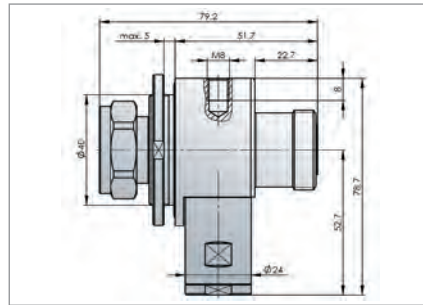

AntPro Lambda/4 7/16 TRI

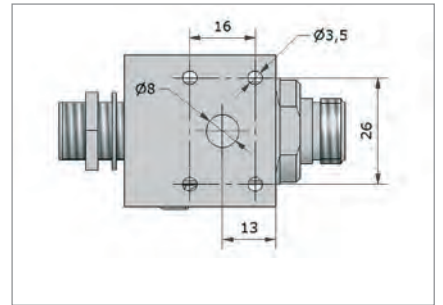

AntPro Koax-GSM-N/230 (f/f)

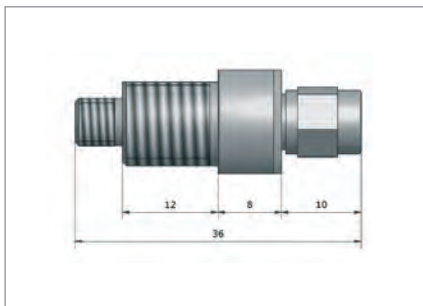

AntPro 5,8GHz SMA

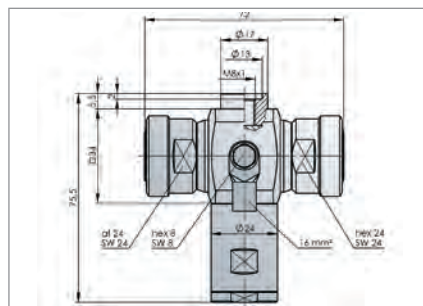

AntPro Lambda/4 7/16 TRI (f/f)

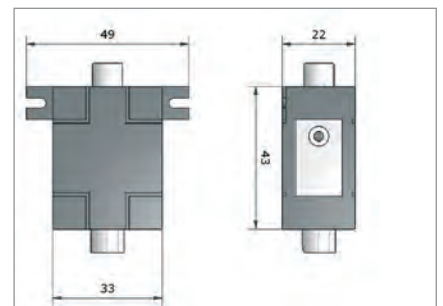

DataPro-SAT and -Radio/TV

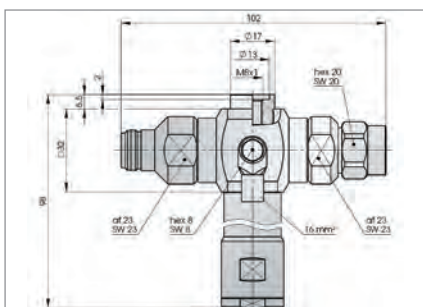

AntPro Lambda/4 N 0.51GHz

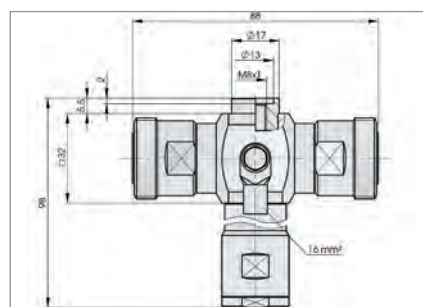

AntPro Lambda 7/16 0.42GHz

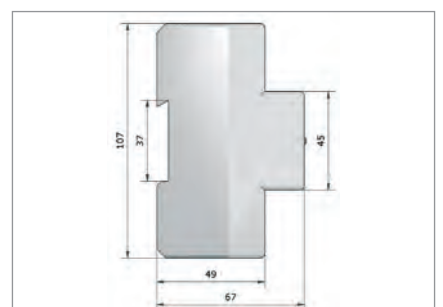

EnerProFilter 230-Tr, EMC Filter

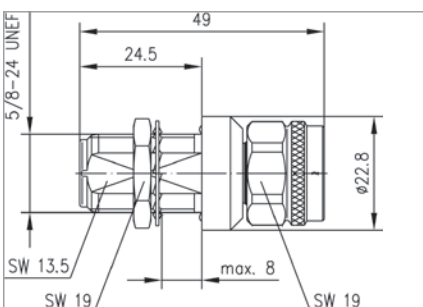

AntPro 6GHz-N (m/f)

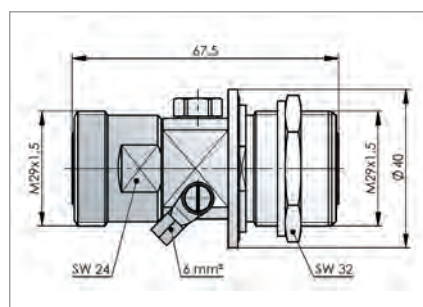

DataPro Koax 7/16 (f/f)

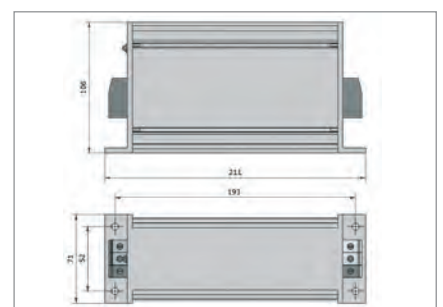

EnerProFilter, EMC Filter (single-phase)

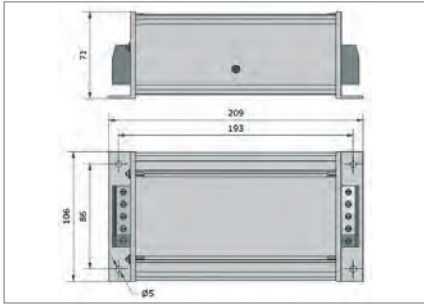

EPF, EMC Filter (three-phase) up to 35 A

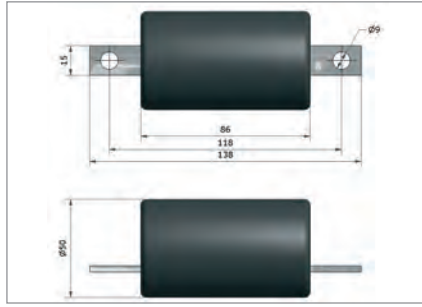

SGO 70 and 350

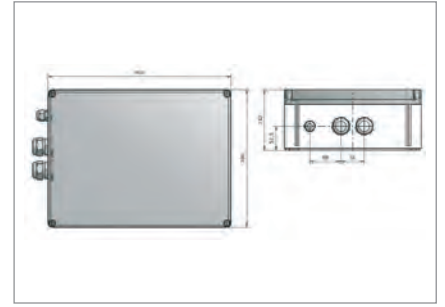

PLPro 40A-iV



EPF, EMC Filter (three-phase) from 63 A

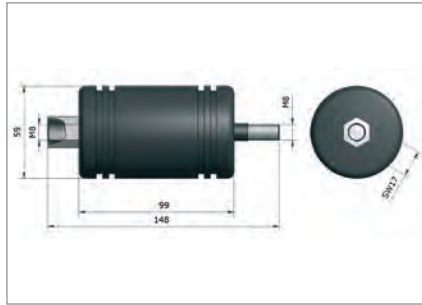

TA 100C and 500C

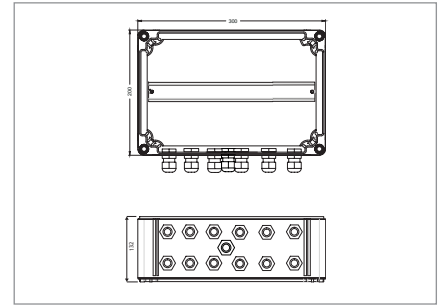

GAK 300 x 200 x 132 mm

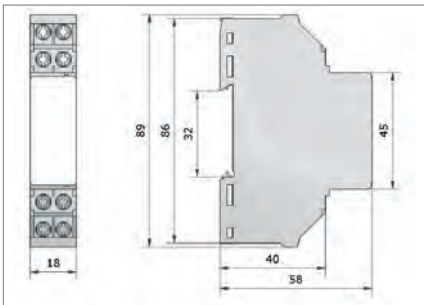

IsoProData 150V/150V-Tr/
DataPro 2x1 and DataPro 3x1

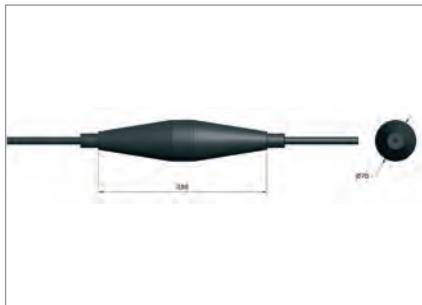

SGO 70QA and 350QA

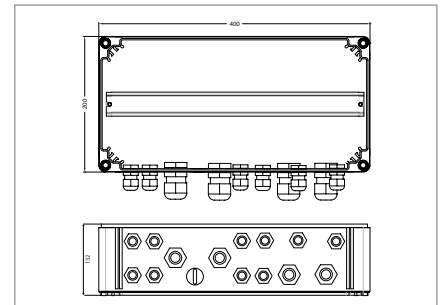

GAK 400 x 200 x 132 mm

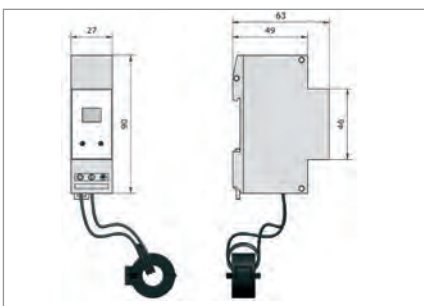

LC1 Lightning counter

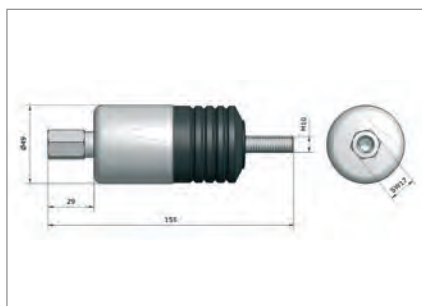

TC 100A and TC 500A

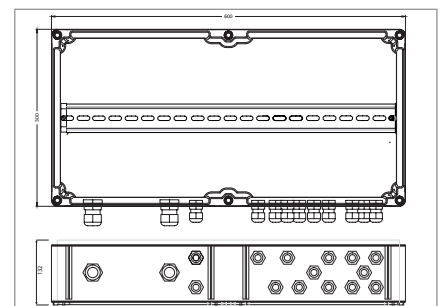

GAK 600 x 300 x 132 mm

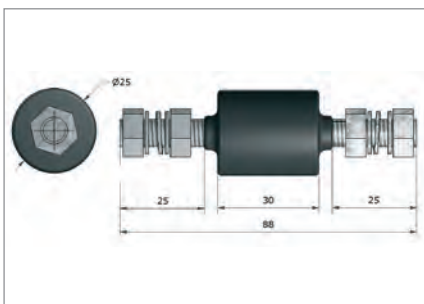

TSF 100 and 500

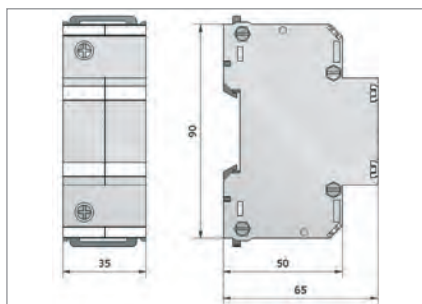

TSF/TF for DIN rail mounting

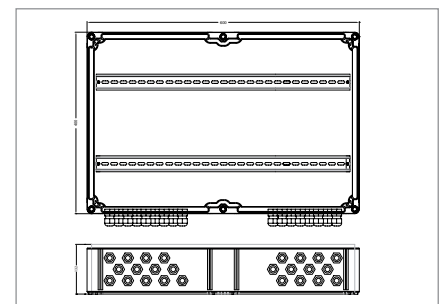

GAK 600 x 400 x 132 mm



It should be noted that protected and unprotected line are separated.

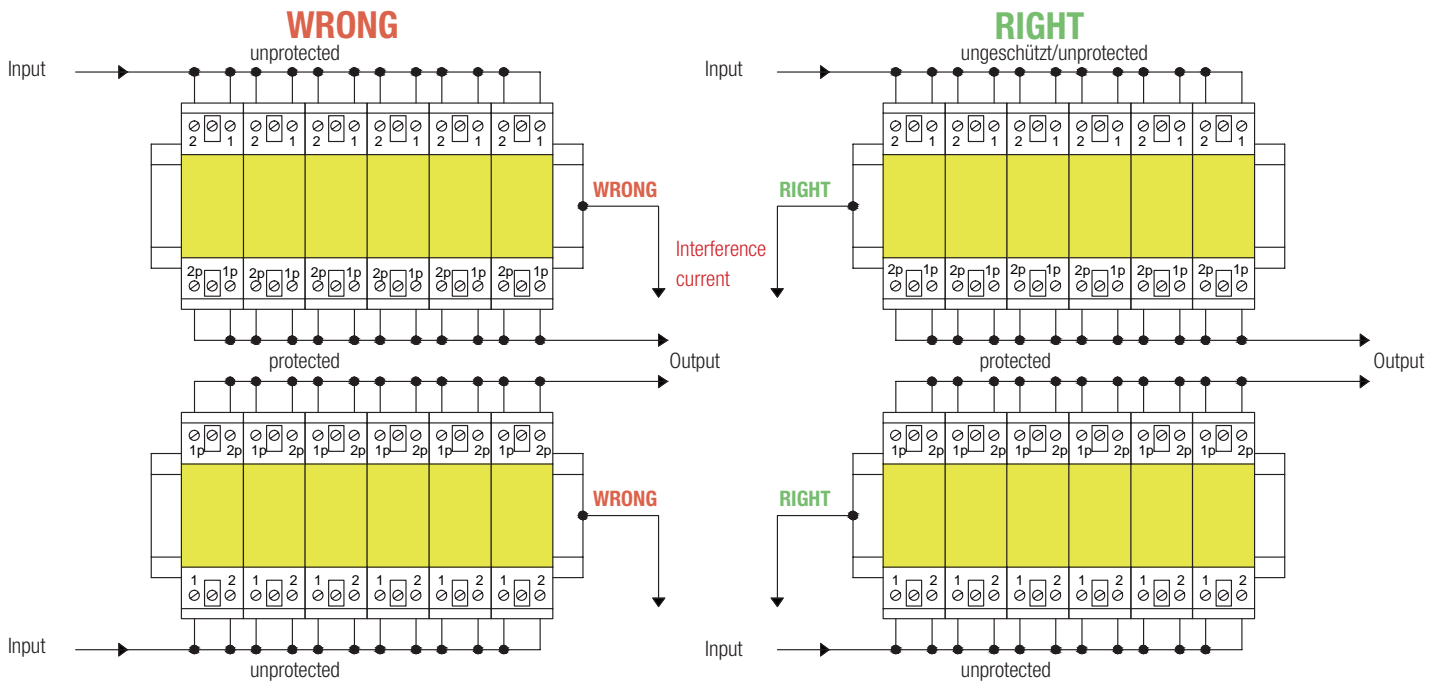

Installation of cable shields

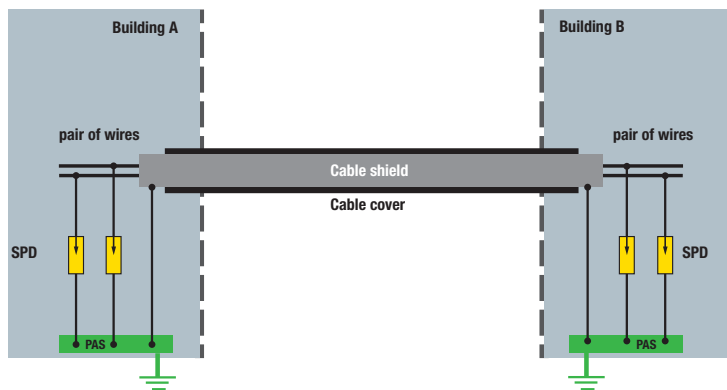

Bilateral directly shielded connection

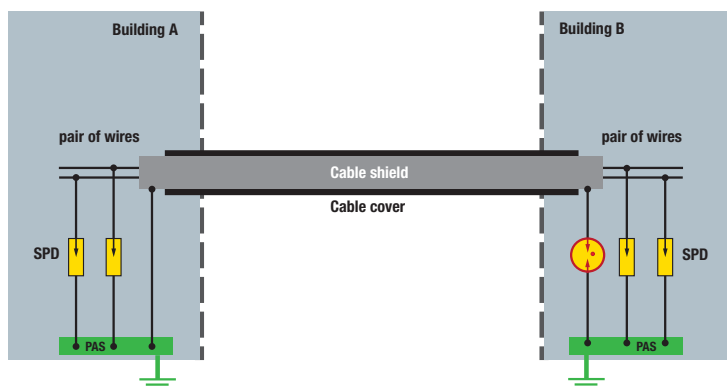

indirectly shielded connection – high resistance grounding

If there is no possibility of earthing the cable shield on both sides because of technological reasons, the non-earthed side has to be connected to the ground via a gas-filled surge arrester (GDT) or an isolation spark gap (up to 100 kA, 10/350 μs).

If a surge occurs, the shield will be connected to the ground via the gas discharge path diverting the energy of the surge. This way, flashovers to the ground, to other cables or installation parts are avoided.



Overview protection level SPD

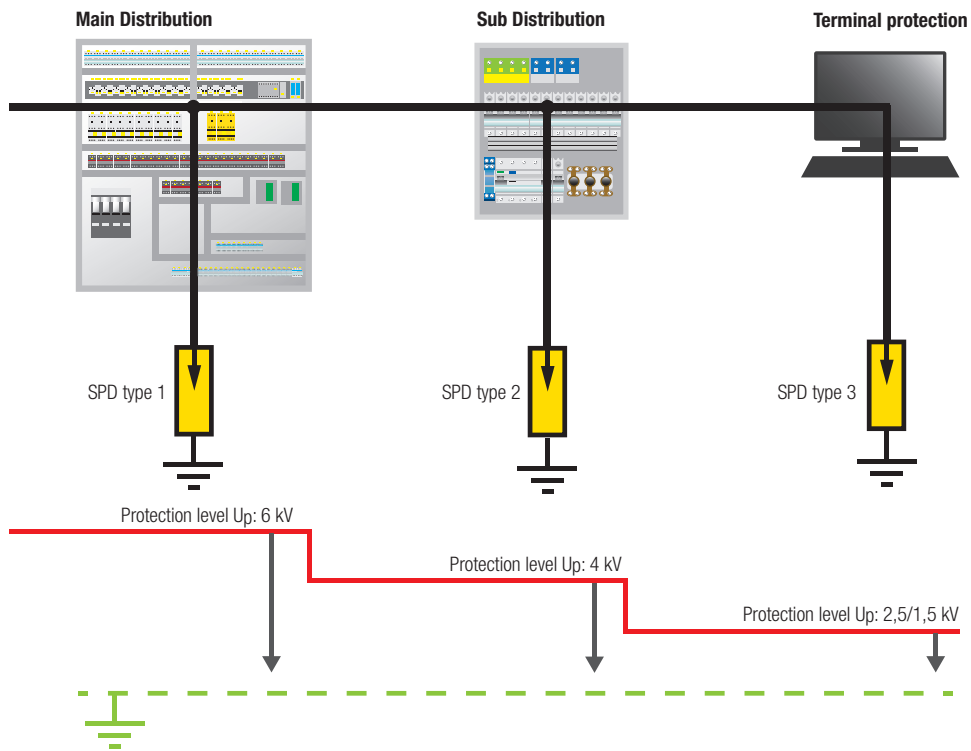

At power supply protection SPDs are always connected parallel to PE, that means: without influence of the lines.

(acc. to DIN VDE 0100-443, overview table 1)

Length of lines

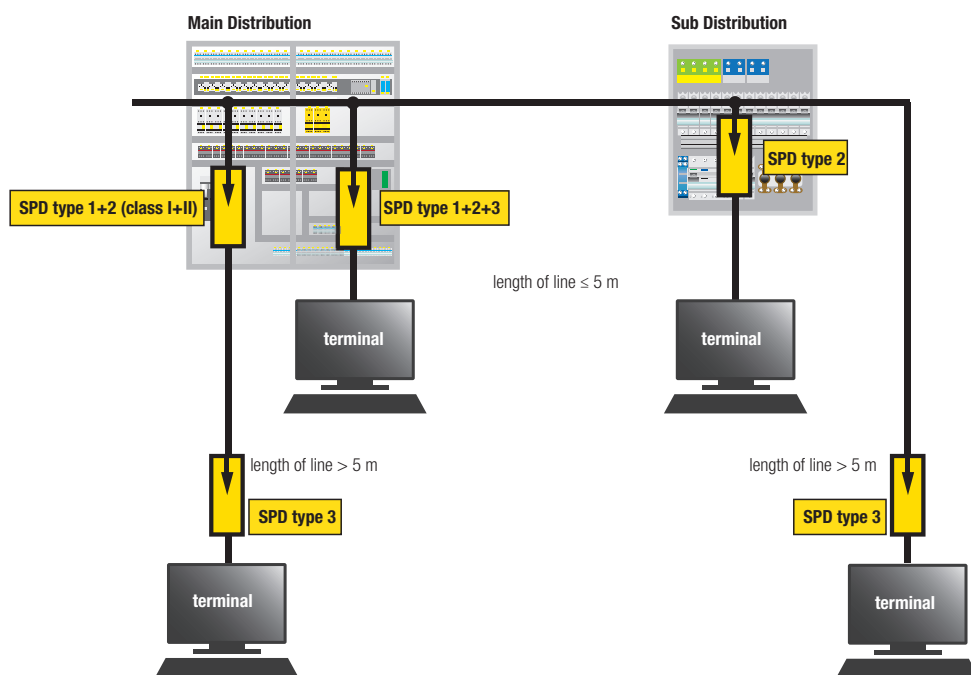



Active Parts

Active parts are conductors and conductive parts of equipment that are alive under normal operational conditions.

Aging

Aging is the alteration of the original conductivity. It is caused by disturbance pulses, normal operation or unfavourable environmental conditions.

Approach (today: Separation Distance)

An approach is a too narrow distance between the lightning protection installation and conductive installations or electrical installations with a risk of a flashover or breakdown at lightning strikes.

Arc Voltages U_{bo}

The arc voltage is the instantaneous value of the voltage over a discharge path during an arc discharge process.

Arresters

Equipment that in general consists of voltage-controlled resistors and/or spark gaps. Both items can be used separately or connected in series or in parallel. Arresters protect other electrical equipment or installations against unacceptable high surge voltages.

Asymmetrical Interference

“Asymmetrical” means that the interference source or drain is related to the ground. It exists a capacitive or galvanic connection to the protective conductor.

Asymmetrical Voltage, Common-Mode Voltage

Average voltage between every conductor and a specified reference point, usually reference earth or ground.

Burst

A burst consists of repeatedly occurring pulses within a certain time period.

Combined Arrester

The combined arrester is a surge-voltage protection device consisting of lightning current arrester and surge arrester.

Combined Impulse

A combined impulse is generated by a combination wave generator which generates a no-load impulse voltage (1.2/50), respectively, a short-circuit impulse current (8/20). The voltage, the amplitude of the current and the waveforms are determined by the generator and the impedance of the SPD. The ratio of the peak values of the no-load voltage and the short-circuit current is 2Ω . This value is called the fictitious impedance Z_f . The short-circuit current is referred to as I_{cs} . U_{oc} is the no-load voltage of the generator.

Critical Discharge Current i_{SG}

The critical discharge current is a current pulse of the waveform 8/20 μs which just about triggers the disconnection device and which does not yet lead to a mechanical damage of the arrester.

Direct or Close-up Strikes

Direct and close-up strikes cause surge voltages with an energy content that contains a considerable part of the total energy of a lightning discharge.

Disconnection Device

If an arrester fails to operate, the disconnection device separates it from the power grid to avoid a fire hazard and to report the defective arrester. Note: It is not the task of the disconnection device to ensure the protective measure „Protection at indirect contact“.

Disturbance Voltage, symmetrical

The symmetrical disturbance voltage is a disturbance voltage between two wires of a conductor (e.g. at a double-circuit line) or between the terminals of an electrical installation for such a line.

Earth

Earth signifies the ground or the soil.

Earthing (noun)

Earthing refers to the total of all means and measures for earthing.

Earthing (verb)

To earth means to connect a conductive part, e.g. the lightning protection installation, via an earth-termination system to the earth.

Earthing Conductor

The earthing conductor connects the installation which has to be earthed with the earthing electrode, as far as the earthing conductor runs above soil or insulated in the soil.

Earthing Electrode

An earthing electrode is a conductor buried into the ground with an electrically conductive connection to the earth. Parts of connectors that run to the earthing electrode which are lying non-insulated in the ground are part of the earthing electrode as well.

Electromagnetic Compatibility (EMC)

The electromagnetic compatibility of a device or a system is its capability of a satisfactory operation in its electromagnetic environment, without causing unacceptable electromagnetic disturbances to other installations in this environment.

Electromagnetic Interference

The electromagnetic interference refers to a quality loss in operational behaviour, a malfunction or the breakdown of an electrical or electronically device caused by an electromagnetic disturbance.

Electrostatic Discharge (e.s.d.)

An electrostatic discharge is the transfer of electric charges between objects with different electrostatic potentials, which takes place at approximation or contact.

Endurance Test

In an endurance test the surge arrester has to undergo load tests, that simulate loads frequently occurring in practice.



Equipotential Bonding (Potential Equalization)

Potential equalization means to remove potential differences (at the operation of consumer's electrical installations), e.g. between the protective conductor of the electrical power installation and the pipes for the water, gas and heating supply, as well as between the individual pipes. The equipotential bonding at lightning effects requires measures beyond the specifications of VDE 0190. Therefore, the lightning protection installation is connected to other conductive installations via conductors or isolation spark gaps and, if necessary, to active parts of electrical installations via surge protection devices. These measures are called "lightning protection potential equalization".

Equipotential Bonding Bar

This bar connects protective conductors, potential equalization conductors and, where applicable, functional earthing conductors with the earthing conductor and the earth electrodes.

Follow-on Current I_f

The follow-on current flows through the SPD after the diverting process. It is supplied from the grid and differs fundamentally from the continuous operating current.

Foundation Earthing Electrode

The foundation earthing electrode is a conductor that is embedded into the concrete foundation of a construction.

Gas-filled Surge Arrester (GDT)

A gas-filled surge arrester is a discharge path filled with another gas than air, normally rare gas.

Ground Resistance

The ground resistance is the resistance between the earthing system and the reference earth. The amount of the ground resistance depends on the interaction of the individual earthing electrodes.

Impulse Current (8/20)

This impulse current has a front time of $8 \mu s$ and a time to half-value of $20 \mu s$.

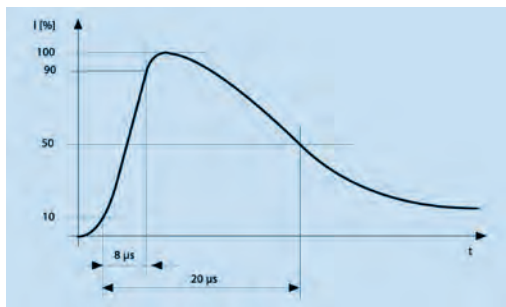

Impulse Discharge Current

Discharge current that flows through the arrester after it is triggered. It is given as a peak value. The nominal impulse discharge current is the peak value of an impulse current of the pulse form 8/20 μs .

Impulse Sparkover Voltage of a Surge Protection Device

Highest voltage value between the electrodes of the spark gap of a surge protection device, just before the sparkover occurs.

Impulse Voltage (1.2/50)

This impulse voltage has a front time (between 10 % and 90 % of its peak value) of $1,2 \mu s$ and a time to half-value of $50 \mu s$ (at $U_{oc} = 6 kV$).

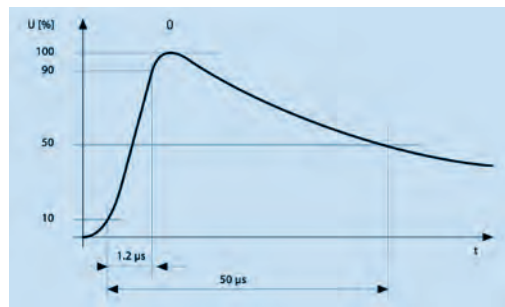

Impulse Withstand Voltage U_{st}

The impulse withstand voltage is the peak value of the highest pulse voltage of a predefined waveform and polarity, which does not result in a breakdown under predefined test conditions. The impulse withstand voltage is equal to or higher as the rated impulse withstand voltage.

Insertion Loss

The insertion loss of an SPD is, at a given frequency, the ratio of the voltages at a supply network point immediately downstream to the SPD before and after the insertion of this SPD. The value is given in decibel.

Insulation Resistance R_{iso}

The insulation resistance is the resistance of the surge arrester in the non-conductive state.

Interference Suppression

Interference suppression comprises all measures to abate or avoid electromagnetic interferences.

Isolation Spark Gap

The isolation spark gap is a spark gap to isolate conductive parts of an installation. When the spark gap is triggered by a lightning strike, the parts are temporarily conducted (lightning-protection equipotential bonding).

Lightning Current Arrester

The lightning current arrester is a surge-voltage protection device which is capable of carrying direct lightning currents.

Lightning Impulse Current Discharge (Lightning Impulse Current)

The 10/350 μs lightning impulse current has a front time of $10 \mu s$ and a time to half-value of $350 \mu s$.

Lightning Impulse Current I_{imp}

The lightning impulse current I_{imp} is defined by its peak value I_{max} , its charge Q and the specific energy W/R with a 10/350 μs waveform.



The test is carried out according to the test procedure of the operation duty test. It is used to classify the test for class I surge protection devices.

Lightning Protection Installation

The lightning protection installation is the sum of all equipment for the external and internal lightning protection of the installation to be protected.

Lightning Surge Voltage

The lightning surge voltage is a surge voltage caused by a lightning discharge.

Longitudinal Voltage Drop

The longitudinal voltage drop is a means (instead of the insertion loss) to evaluate overvoltage arresters for d.c. voltages or low operating frequencies up to a maximum of 400 Hz. The longitudinal voltage drop is measured along the current path or paths at nominal current and, where applicable, operating frequency.

Main Supply Short-Circuit Current I_K

The main supply short-circuit current is the short-circuit current which results from the impedance of the test network and the connecting cables at the installation point of the test object.

Measured Limiting Voltage

Maximum voltage that is measured at the terminals of an SPD while pulses with a preset form and amplitude are applied.

Nominal Alternating Discharge Current I_{wn}

The nominal alternating discharge current is the alternating current with frequencies between 15 and 62 Hz (primarily 50 Hz), which the test object is dimensioned for in a specific test procedure.

Nominal Impulse Discharge Current I_n

The nominal impulse discharge current is the peak value of a current with the waveform 8/20 that flows through a surge protection device. It is used to classify the test for class II surge protection devices.

Nominal Load Current I_L

The nominal load current is the maximum continuous, alternating or direct current which can flow from the output of an SPD to the connected load.

Nominal Voltage U_N

The nominal voltage, as a rounded voltage value, specified by the manufacturer of an electrical apparatus to identify it and to specify the voltage range for which it is designed.

Overvoltage Category

The overvoltage category is the classification of a piece of electrical equipment to the expected overvoltages.

Potential Equalization Conductor

The potential equalization conductor is a conductive link to achieve potential equalization.

Potential Equalization Installation

The potential equalization installation is the total of all interconnected potential equalization conductors, including all other conductive parts which work in the same way, e.g. housings or other conductive installations. The potential equalization installation can either be the earth-termination system or part of it.

Power-Frequency Withstand Voltage

The power-frequency withstand voltage is the r.m.s. value of the highest sinusoidal voltage at system frequency, which does not result in a breakdown under predefined test conditions.

Protection Level Up

The protection level is a parameter which characterizes the performance of an SPD to limit the voltage between its terminals. The protection level is chosen from a list of standard values and has to exceed the highest value of the measured limiting voltages.

Protection Path

The parts of an SPD can be connected as “conductor against conductor” or “neutral conductor against earth”, or a combination of these possibilities. These methods of connection are called protection paths.

Pulse

A pulse is a rapid, temporary change of a physical parameter followed by a fast change back to the original value.

Rate of Rise

The rate of rise is the average change rate of a parameter between two certain values, e.g. between 10 % and 90 % of the peak value.

Rated Voltage of an Arrester U_c

Maximum acceptable root-mean-square value of the power-frequency a.c. voltage that can be permanently applied to the terminals of the arrester.

Reference Earth

Reference earth is the reference ground (especially the earth's surface) that is so far apart from the earthing electrodes that, if a current is diverted into the ground, no relevant voltage differences occur between the points of this area.

Remote Signalling Contact

Remote signalling contacts belong to a circuit which is separated from the main circuit of the SPD. The disconnection device of the SPD and/or an operation indication are part of the same circuit.

Remote Strikes

Remote strikes cause surges with a considerable smaller energy content compared to close-up strikes.



Residual Current Protective Device (RCD)

Residual current protective devices disconnect the circuit if the residual current against earth exceeds a certain value.

Residual Voltage Ures

The residual voltage is the peak value of the voltage that appears between the terminals of an SPD during the flow of a discharge current or immediately after it.

Short-circuit Withstand Capability

The short-circuit withstand capability is the highest unaffected short-circuit current the surge protection device can withstand.

Sparkover Voltage

The sparkover voltage is the highest instantaneous value of the voltage at the terminals of an arrester, just before it is triggered.

Specialist in Lightning Protection

A specialist in lightning protection has a professional training, knowledge and expertise as well as knowledge of the corresponding regulations that allow him to assess the work assigned to him as well as to identify possible dangers. (To judge the professional training, one can also consider several years of working in the corresponding field.)

Status Display

The status display indicates the state of operation of an SPD.

Surge Voltage

A surge voltage is a voltage that puts people and/or technical equipment like conductors and devices at risk. It can permanently (over-voltage) or temporarily (surge voltage) occur between conductor and earth in error-free installations (in disconnected conductors as well).

Surge-voltage Protection Device (SPD)

A surge-voltage protection device limits transient surges and diverts impulse currents. It includes at least one non-linear component.

Temperature Range

The temperature range describes the lowest and highest temperatures that are allowed at or inside the housing. For devices without self-heating this range refers to the ambient temperature. For devices with self-heating it indicates the maximum operating temperature range.

TOV Characteristics

The TOV characteristics describe the behaviour of an SPD to which a temporary overvoltage (TOV) is applied for a certain period of time.

Transient

A transient is a non-periodic and very short positive or negative change of voltage or current between two steady states.

transient

A transient behaviour describes the behaviour of a phenomenon or value which changes between two consecutive steady states in a very short time in comparison to the considered timescale.

Transverse Voltage

The transverse voltage is the interference voltage which occurs between two conductors of the same circuit.

Triggering Current of the Disconnection Device

The triggering current of the disconnection device is the root-mean-square value of the current through the arrester, which causes the disconnection device to operate within 30 seconds.

Triggering

Triggering is referred to, if either the peak value of the ohmic component of the current through the arrester reaches 5 mA or a voltage drop caused by the rise of the peak value of the current through the arrester exceeds 5 mA.

Varistors

A varistor is a bipolar non-linear resistor with symmetrical voltage-current characteristics. Its resistance decreases with increasing voltage.

Withstand Voltage

The withstand voltage is the maximum voltage that can be applied to a current-limiting component of an SPD without affecting it. This voltage can be equal to the highest continuous operating voltage U_c of the SPD or higher, depending on the components inside the SPD.

Abbreviations

CCP	Cathodic Corrosion Protection
CCPS	Cathodic Corrosion Protection System
EBS	Equipotential Bonding Strip
ESD	Electrostatic Discharge
FM	Remote Signalling Contact (Changeover Contact)
FS	Fail-safe
GDT	Gas-Filled Surge Arrester
LEMP	Lightning Electromagnetic Impulse
LPL	Lightning Protection Level
LPMS	LEMP Protection Measures System
LPS	Lightning Protection System
LPZ	Lightning Protection Zone
MBC	Miniature Circuit Breaker
MOV	Metalloxyd Varistor
PK	Potential-free Contact (Break Contact)
RCD	Residual Current Device
SEMP	Switching Electromagnetic Pulse
SPD	Surge Protective Device
SSCT	Solderless and Screwless Connection Technology
SVE	Surge Voltage Protection Equipment
SVP	Surge Voltage Protector
TAB	Technical Connection Requirements for Electrical Power Installations
TOV	Temporary Overvoltage
VDEW	Vereinigung deutscher Elektrizitätswerke e.V. (German Association for the Power Supply Industry)
VdS	Verband der Sachversicherer (Property Insurer Association)



Article-No.	Product	Page	Article-No.	Product	Page	Article-No.	Product	Page
04 00 01	AntPro Koax-GSM-N/230	125	22 30 30	DataPro Z-30V/30V	145	24 01 13	TelPro LSA-2EH230-10kA	104
04 00 04	AntPro Koax-GSM-N/230(f/f)	125	22 36 36	DataPro Z-36V/36V	145	24 01 14	TelPro LSA-2EH230F-10kA	104
04 00 10	AntPro 6GHz-N(m/f)	126	22 48 48	DataPro Z-48V/48V	145	24 01 15	TelPro LSA-2EL230-20kA	104
04 00 11	AntPro 6GHz-N(f/f)	126	22 60 60	DataPro Z-60V/60V	145	24 01 16	TelPro LSA-2EH350-10kA	104
04 00 20	AntPro Lambda/4 N 0.51GHz	122	23 00 00	DataPro Z-RLC	145	24 01 17	TelPro LSA-2EH90-10kA	104
04 00 21	AntPro Lambda/4 N 0.51GHz (f/f)	122	23 90 00	DataPro-RJ45-48V-Tr	98	24 01 18	TelPro LSA 2/10-3E 8x13	105
04 00 22	AntPro Lambda/4 N 0.8GHz	122	24 00 02	EnerPro 230 SDU	49	24 01 19	TelPro LSA 2/10-3EH230E-10kA	105
04 00 23	AntPro Lambda/4 N 2.0GHz	122	24 00 04	DataPro-TAE/NFN-aP	102	24 01 23	TelPro LSA-3EH230F1E-10kA	105
04 00 24	AntPro Lambda/4 N 2.0GHz (f/f)	122	24 00 05	DP RJ45-CAT6-48V-Tr	98	24 01 24	TelPro LSA-3EL230E-20kA	105
04 00 30	AntPro Lambda/4 7/16 TRI	123	24 00 11	DP RJ45 f/f	99	24 01 25	TelPro LSA-3EL230F1E-20kA	105
04 00 31	AntPro Lambda/4 7/16 TRI (f/f)	123	24 00 13	DataPro ISDN-aP	102	24 01 26	TelPro LSA-3EH90E-10kA	105
04 04 25	AntPro Lambda/4 7/16 0.42GHz	123	24 00 17	DP2-2MB-Tr	143	24 01 27	TelPro LSA-3EH90F1E-10kA	105
04 58 00	AntPro 5,8GHz-SMA	121	24 00 18	DataPro 2x1-SDSL-Tr	82	24 01 28	TelPro LSA 2/10-2E 8x20	107
04 58 02	AntPro 5,8GHz-R-SMA	121	24 00 20	DataPro 4x1-SDSL-Tr	82	24 01 29	TelPro LSA 2EY230-20kA	107
10 10 00	DP Koax 7/16	124	24 00 21	DP 1xRJ45-PoE-Alu	99	24 01 31	TelPro LSA-2EY90-20kA	107
10 10 01	DP Koax 7/16 (f/f)	124	24 00 24	DataPro 2x1-24V-SDSL-Tr	82	24 01 32	TelPro LSA-2EY350-20kA	107
16 02 00	H45	150	24 00 25	DP 10LSA-12V	113	24 01 33	LSA 2/10-ES	115
16 05 20	DP FME-AD	121	24 00 26	DP 10LSA-PTC-12V	114	24 01 36	LSA 2/10 KS-120	115
17 00 13	KA 1TE-1/3	60	24 00 27	DP 10LSA-24V	113	24 01 37	LSA DIN ADAPT	115
17 00 15	KA 1TE-1/2	60	24 00 28	DP 10LSA-PTC-24V	114	24 01 40	DP 10LSA-110	113
17 00 25	KA 2TE-1/4	60	24 00 31	DP 1LSA-5	108	24 01 42	DP 10LSA-PTC 110	114
17 00 31	KA 1TE-1/6	60	24 00 32	DP 1LSA-12	108	24 12 00	EnerPro 12V-Tr	53
17 00 41	KA 2TE-1/4	60	24 00 33	DP 1LSA-15	108	24 12 02	EnerPro 12V-6A/LED	51
17 00 42	KA 1TE-1/8	60	24 00 34	DP 1LSA-24	108	24 12 03	EP 12V-20A/LED	52
17 01 00	AK35 GDT230	60	24 00 36	DP 1LSA-30	109	24 24 00	EnerPro 24V-Tr	53
17 01 10	DAK 2x 16	192	24 00 37	DP 1LSA-48	109	24 24 02	EnerPro 24V-6A/LED	51
17 01 20	ST-D 1200	192	24 00 38	DP 1LSA-60	109	24 24 03	EP 24V-20A/LED	52
17 01 21	ST-D 1200-500	192	24 00 39	DP 1LSA-110	109	24 36 00	EnerPro 36V-Tr	53
17 01 40	E-Membran M12	192	24 00 40	DP 1LSA-5-PTC	109	24 36 02	EnerPro 36V-6A/LED	51
17 01 50	ST-SI/2A	192	24 00 41	DP 1LSA-12-PTC	109	24 36 03	EP 36V-20A/LED	52
17 01 51	ST-SI/4A	192	24 00 42	DP 1LSA-15-PTC	109	24 48 00	EnerPro 48V-Tr	53
17 01 52	ST-SI/8A	192	24 00 43	DP 1LSA-24-PTC	109	24 48 03	EP 48V-20A/LED	52
17 01 53	ST-SI/10A	192	24 00 44	DP 1LSA-48-PTC	110	24 60 00	EnerPro 60 V-Tr	53
17 01 54	ST-SI/12A	192	24 00 45	DP 1LSA-60-PTC	110	25 30 16	EPF 230V/16A-Tr	132
17 01 55	ST-SI/15A	192	24 00 46	DP 1LSA-110-PTC	110	25 30 17	EPF 230V/25A-Tr	132
17 01 56	ST-SI/20A	192	24 00 47	DP 1LSA-180FS	110	25 30 20	EPF 230V/16A-S	133
17 01 66	MW-AntPro	126	24 00 48	DP 1LSA-T110FS-PTC	110	25 30 22	EPF 60V/16A-S	133
19 40 13	DP 1x8RJ45-19"	100	24 00 49	DP 1LSA-TK180FS	110	25 30 25	EPF 230V/16A-W	133
19 40 23	DP 2x8RJ45-19"	100	24 00 61	DP 1LSA-C48FS-PTC	112	25 30 45	EPF 230/400V/16A-W	134
19 40 33	DP 3x8RJ45-19"	100	24 00 62	DP 1LSA-C60FS-PTC	112	25 30 53	EPF 48V/25A-S	133
19 40 43	DP 4x8RJ45-19"	100	24 00 63	DP 1LSA-C5FS-PTC	111	25 30 80	EPF 230/400V/25A-W	134
19 40 50	DP 8xRJ45-6V-WG	101	24 00 64	DP 1LSA-C12FS-PTC	111	25 30 85	EPF 230V/35A-S	133
19 40 51	DP-8xRJ45-6x6V/2x48V-WG	101	24 00 65	DP 1LSA-C15FS-PTC	111	25 31 00	EPF 230/400V/35A-W	134
19 40 53	DP 5x8RJ45-19"	101	24 00 66	DP 1LSA-C24FS-PTC	111	25 31 30	EPF 230/400V/63A-E	135
19 40 63	DP 6x8RJ45-19"	101	24 01 00	LSA 2/10-AN	115	25 31 40	EPF 230/400V/100A-E	135
21 00 20	DataPro-SAT	127	24 01 02	LSA 2/10-TR	115	25 31 60	EPF 230/400V/200A-E	135
21 00 30	DataPro-Radio/TV	127	24 01 04	LSA 2/10-ER38-rot	115	26 09 90	EMV-FKL	73
22 06 06	DataPro Z-6V/6V	144	24 01 06	TelPro LSA 2/10-2E 8x6	104	26 12 12	DP 2x1-12V/12V-0,3Ω-Tr	141
22 12 12	DataPro Z-12V/12V	144	24 01 08	LSA 2/10 KSR	115	26 24 24	DP 2x1-24V/24V-0,3Ω-Tr	141
22 15 15	DataPro Z-15V/15V	144	24 01 09	LSA 2/10 AD	115	26 30 30	DP 2x1-30V/30V-0,3Ω-Tr	141
22 24 24	DataPro Z-24V/24V	144	24 01 10	LSA 2/10-MW10-25/22	115	26 36 36	DP 2x1-36V/36V-0,3Ω-Tr	141

PRODUCT REGISTER

NUMERIC

Article-No.	Product	Page
26 60 60	DP 2x1-60V/60V-0,3Ω -Tr	141
27 00 00	DP 2x1-RLC-Tr	142
27 03 03	IsoProData 150V/150V-Tr	136
27 04 04	DP2x1-150V/150V-Tr	138
27 04 85	DP-RS 485-Tr	83
27 06 06	DP2x1-6V/6V-Tr	137
27 12 12	DP2x1-12V/12V-Tr	137
27 15 15	DP2x1-15V/15V-Tr	137
27 24 24	DP2x1-24V/24V-Tr	137
27 30 02	IsoProData-Tr	84
27 30 30	DP2x1-30V/30V-Tr	138
27 36 36	DP2x1-36V/36V-Tr	138
27 48 48	DP2x1-48V/48V-Tr	138
27 60 60	DP2x1-60V/60V-Tr	138
27 80 80	DP2x1-80V/80V-Tr	138
27 90 00	DP 2x8-36V/36V-Tr/GO	143
27 90 01	DP 2x8-36V/36V-Tr/GU	143
28 04 04	DP3x1-150V/150V-Tr	140
28 12 12	DP3x1-12V/12V-Tr	139
28 15 15	DP3x1-15V/15V-Tr	139
28 24 24	DP3x1-24V/24V-Tr	139
28 30 30	DP3x1-30V/30V-Tr	139
28 36 36	DP3x1-36V/36V-Tr	140
28 48 48	DP3x1-48V/48V-Tr	140
28 60 60	DP3x1-60/60V-Tr	140
28 70 50	DP 2x1-RLC/50V-Tr	142
29 60 00	EnerPro 65V/12A-Tr	171
29 60 02	EnerPro 65V/12A-Tr/FM	171
35 10 30	UAS 230-Tr	60
36 05 22	NM 220V/5kA	49
36 20 22	NM 220V/20kA	49
36 20 23	NM 220V/20kA/PK	49
36 20 35	EP D 230 KM	48
37 12 00	PP BCD TN 25/50/LED	31
37 12 02	PP BCD TN 25/50/LED/FM	31
37 38 23	SP BC NPE 100	21
37 38 24	SP BC NPE 100/FM	21
37 38 25	IP BC 25	26
37 38 26	IP BC 25/FM	26
37 38 30	IP BC 60	26
37 38 40	PowerPro-B-Tr/50kA/Pk	14
37 38 50	PowerPro BCD-Tr/25kA	31
37 38 51	PP BCD-Tr/25kA-VA	31
37 38 52	PP BCD-Tr/25kA-350	31
37 38 55	PP BCD 27kA	32
37 38 58	PP BCD 27kA-350	32
37 38 60	PowerPro BCD-Tr/25kA/PK	31
37 38 61	PP PCD-Tr/25kA-VA/FM	31
37 38 62	PP BCD-Tr/25kA/FM-350	31
37 38 65	PP BCD 27kA/FM	32
37 38 68	PP BCD 27kA/FM-350	32

Article-No.	Product	Page
37 38 88	PP BCD 25-350	31
37 38 89	PP BCD 25-350/FM	31
37 39 10	PP B TT 50/100	13
37 39 12	PP B TT 50/100/FM	13
37 39 15	PP B TT2+1 50/100	13
37 39 17	PP B TT2+1 50/100/FM	13
37 39 18	PP B IT 50/100	14
37 39 19	PP B IT 50/100/FM	14
37 39 20	PP BC TT 25/100	20
37 39 22	PP BC TT 25/100/FM	20
37 39 30	PP BCD TT 25/100	30
37 39 32	PP BCD TT 25/100/FM	30
37 39 34	PP BCD TT2+1 25/100	30
37 39 36	PP BCD TT2+1 25/100/FM	30
37 39 40	PP B TNS 50/100	12
37 39 42	PP B TNS 50/100/FM	12
37 39 43	PP B TNS 440	12
37 39 44	PP B TNS 440/FM	12
37 39 45	PP B TN 440	13
37 39 46	PP B TN 440/FM	13
37 39 50	PP BC TNS 25/100	19
37 39 52	PP BC TNS 25/100/FM	19
37 39 56	PP BCD TNC 75/LED	32
37 39 57	PP BCD TNC 75/LED/FM	32
37 39 58	PP BCD TT 100/LED	32
37 39 59	PP BCD TT 100/LED/FM	32
37 39 60	PP BCD TNS 25/100	29
37 39 62	PP BCD TNS 25/100/FM	29
37 39 64	PP B TNC 440	13
37 39 65	PP B TNC 440/FM	13
37 39 70	PP B TNC 50/100	12
37 39 72	PP B TNC 50/100/FM	12
37 39 80	PP BC TNC 25/75	19
37 39 81	PP BC TNC 440	20
37 39 82	PP BC TNC 25/75/FM	19
37 39 83	PP BC TNC 440/FM	20
37 39 90	PP BCD TNC 25/75	29
37 39 92	PP BCD TNC 25/75/FM	29
37 41 10	PP B TNC 50/100-350	13
37 41 15	PP B TNC 50/100/FM-350	13
37 41 20	PP B TNS 50/100-350	12
37 41 25	PP B TNS 50/100/FM-350	12
37 41 30	PP B TT 50/100-350	13
37 41 35	PP B TT 50/100/FM-350	13
37 44 00	PP PV 800	54
37 44 01	PP PV 800/FM	54
37 44 02	PP PV 1000	54
37 44 03	PP PV 1000/FM	54
37 45 00	PP BC 50-440	22
37 45 01	PP BC 50-440/FM	22
37 45 04	PP BC TNC 50-400/690	22

Article-No.	Product	Page
37 45 05	PP BC TNC 50-400/690/FM	22
37 45 20	PP B 25-760	14
37 45 21	PP B 25-760/FM	14
38 05 24	EP D TNC 275	43
38 05 25	EP D TNC 275/FM	43
38 05 30	EP D TNS 275	43
38 05 31	EP D TNS 275/FM	43
38 05 35	EP D TT 275	43
38 05 36	EP D TT 275/FM	43
38 05 38	EP D TT1+1 275	43
38 05 39	EP D TT1+1 275/FM	43
38 05 40	EP D TT2+1 275	43
38 05 41	EP D TT2+1 275/FM	43
38 05 48	EP D TN 275V/25A-FM	47
38 05 49	EP D TN 48V/25A	46
38 05 50	EP D TN 24V/16A	45
38 05 51	EP D TN 24V/16A/FM	45
38 05 52	EP D TN 24V/25A	46
38 05 53	EP D TN 48V/16A	45
38 05 54	EP D TN 48V/16A/FM	45
38 05 55	EP D TN 24V/25A-FM	46
38 05 56	EP D TN 60V/16A	45
38 05 57	EP D TN 60V/16A/FM	45
38 05 58	EP D TN 48V/25A-FM	46
38 05 59	EP D TN 120V/16A	45
38 05 60	EP D TN 120V/16A/FM	45
38 05 61	EP D TN 275V/25A	47
38 05 62	EP D TN 230V/16A	46
38 05 63	EP D TN 230V/16A/FM	46
38 05 64	EP D TN 60V/25A	46
38 05 65	EP D TN 60V/25A-FM	46
38 05 66	EP D TN 120V/25A	46
38 05 67	EP D TN 120V/25A-FM	46
38 05 68	EP D TN 230V/25A	47
38 05 69	EP D TN 230V/25A-FM	47
38 05 70	EP D IT 2P	44
38 05 71	EP D IT 2P/FM	44
38 05 76	EP D IT 3P	44
38 05 77	EP D IT 3P/FM	44
38 09 10	EP C TT2+1-110	39
38 09 11	EP C TT2+1-110/FM	39
38 11 30	PP B TT1+1 50/100	13
38 11 31	PP B TT1+1 50/100/FM	13
38 11 32	PP BC TT1+1 25/100	20
38 11 33	PP BC TT1+1 25/100/FM	20
38 11 34	PP BCD TT1+1 25/100	30
38 11 35	PP BCD TT1+1 25/100/FM	30
38 11 36	PP BCD TT1+1 25/100/2LED	30
38 11 40	IP B TNC 60/100	15
38 11 41	IP B TNC 60/100/FM	15
38 11 42	IP BC TNC 60/100	24



Article-No.	Product	Page	Article-No.	Product	Page	Article-No.	Product	Page
38 11 43	IP BC TNC 60/100/FM	24	38 12 33	IP B TN 60/100/FM	16	38 51 80	PP BC TN 25/50-350	20
38 11 45	IP B TNS 60/100	15	38 12 34	IP BC TN 60/100	25	38 51 90	PP BC TN 25/50/FM-350	20
38 11 46	IP B TNS 60/100/FM	15	38 12 35	IP BC TN 60/100/FM	25	38 52 00	PP BC TT1+1 25/100-350	20
38 11 47	IP BC TNS 60/100	23	38 12 36	IP B TN 25/50	16	38 52 10	PP BC TT1+1 25/100/FM-350	20
38 11 48	IP BC TNS 60/100/FM	23	38 12 37	IP B TN 25/50/FM	16	38 52 80	IP BC TNC 60/100-350	24
38 11 50	IP B TT 60/100	16	38 12 38	IP BC TN 25/50	25	38 52 90	IP BC TNC 60/100/FM -350	24
38 11 51	IP B TT 60/100/FM	16	38 12 39	IP BC TN 25/50/FM	25	38 53 00	IP BC TNC 25/75-350	24
38 11 52	IP BC TT 60/100	24	38 12 47	EP C TN 275	40	38 53 10	IP BC TNC 25/75/FM-350	24
38 11 53	IP BC TT 60/100-LED	26	38 12 48	EP C TN 275/FM	40	38 53 20	IP BC TNS 60/100-350	23
38 11 54	IP BC TT 60/100/FM	24	38 12 52	EP C TN 275-D	40	38 53 30	IP BC TNS 60/100/FM-350	23
38 11 55	IP B TT1+1 60/100	16	38 12 54	EP D TN 275	46	38 53 40	IP BC TNS 25/100-350	23
38 11 56	IP B TT1+1 60/100/FM	16	38 12 55	EP D TN 275/FM	46	38 53 50	IP BC TNS 25/100/FM-350	23
38 11 57	IP BC TT1+1 60/100	25	38 14 00	EP C TN 75	40	38 53 60	IP BC TT 60/100-350	24
38 11 58	IP BC TT1+1 60/100/FM	25	38 14 05	EP C TN 75/FM	40	38 53 70	IP BC TT 60/100/FM-350	24
38 11 59	IP BC TT1+1 60/100-LED	26	38 15 00	EP C IT 2P	41	38 53 80	IP BC TT 25/100-350	24
38 11 60	IP BC TT2+1 60/100-LED	26	38 15 01	EP C IT 2P/FM	41	38 53 90	IP BC TT 25/100/FM-350	24
38 11 61	IP BC TT2+1 60/100-LED/FM	26	38 15 10	EP C IT 3P 440	41	38 54 00	IP BC TN 60/100-350	25
38 11 63	IP BC TT 60/100-LED/FM	26	38 15 11	EP C IT 3P 440/FM	41	38 54 10	IP BC TN 60/100/FM-350	25
38 11 76	EP C TNC 275	38	38 20 22	EnerPro 220Tr/20kA	47	38 54 20	IP BC TN 25/50-350	25
38 11 77	EP C TNC 275/FM	38	38 20 23	EnerPro 220Tr/20kA/PK	47	38 54 30	IP BC TN 25/50/FM-350	25
38 11 78	EP C TNS 275	38	38 20 25	EnerPro 150Tr/Pk	48	38 54 40	IP BC TT1+1 60/100-350	25
38 11 79	EP C TNS 275/FM	38	38 20 28	EnerPro 280Tr	40	38 54 50	IP BC TT1+1 60/100/FM-350	25
38 11 80	EP C TT 275	39	38 20 29	EnerPro 280Tr/Pk	40	38 54 60	IP BC TT1+1 25/100-350	25
38 11 81	EP C TT 275/FM	39	38 20 42	EnerPro 284Tr-M	42	38 54 70	IP BC TT1+1 25/100/FM-350	25
38 11 82	EP C TT1+1 275	39	38 20 43	EnerPro 284Tr-M/Pk	42	38 55 40	EP C TN 350	40
38 11 83	EP C TT1+1 275/FM	39	38 20 44	EnerPro 282Tr-M	42	38 55 50	EP C TN 350/FM	40
38 11 88	EP C TT1+1 350	39	38 20 45	EnerPro 282Tr-M/Pk	42	38 55 60	EP C TNC 350	38
38 11 91	EP C TT1+1 350/FM	39	38 20 70	EnerPro 48V/100A-Tr	50	38 55 70	EP C TNC 350/FM	38
38 12 10	PP B TN 50/100	13	38 20 71	EnerPro 48V/100A-Tr/Pk	50	38 55 80	EP C TNS 350	38
38 12 11	PP B TN 50/100/FM	13	38 20 80	EP CV 2P 65V/63A-LED	171	38 55 90	EP C TNS 350/FM	38
38 12 12	PP BC TN 25/50	20	38 20 83	EP CV 2P 65V/63A/FM-LED	171	38 56 00	EP C TT 350	39
38 12 13	PP BC TN 25/50/FM	20	38 20 86	EP CV 2P 100V/63A-LED	171	38 56 10	EP C TT 350/FM	39
38 12 14	PP BCD TN 25/50	31	38 20 87	EP CV 2P 100V/63A/FM-LED	171	38 80 00	EL-T2-75-M	33
38 12 15	PP BCD TN 25/50/FM	31	38 50 00	PP BCD TNC 25/75-350	29	38 80 01	EL-T2-130-M	33
38 12 16	IP B TNC 25/75	15	38 50 10	PP BCD TNC 25/75/FM-350	29	38 80 02	EL-T2-275-M	33
38 12 17	IP B TNC 25/75/FM	15	38 50 20	PP BCD TNS 25/100-350	29	38 80 03	EL-T2-350-M	33
38 12 18	IP BC TNC 25/75	24	38 50 30	PP BCD TNS 25/100/FM-350	29	38 80 04	EL-T2-440-M	33
38 12 19	IP BC TNC 25/75/FM	24	38 50 40	PP BCD TT 25/100-350	30	38 80 05	EL-T2-550-M	33
38 12 20	IP B TNS 25/100	15	38 50 50	PP BCD TT 25/100/FM-350	30	38 80 06	EL-T2-750-M	33
38 12 21	IP B TNS 25/100/FM	15	38 50 60	PP BCD TN 25/50-350	31	38 80 07	EL-T2-NPE-M	33
38 12 22	IP BC TNS 25/100	23	38 50 70	PP BCD TN 25/50/FM-350	31	38 81 01	EL-T2/4+0-130-FM	33
38 12 23	IP BC TNS 25/100/FM	23	38 50 80	PP BCD TT1+1 25/100-350	30	38 81 02	EL-T2/4+0-275-FM	33
38 12 24	IP B TT 25/100	16	38 50 90	PP BCD TT1+1 25/100/FM-350	30	38 81 03	EL-T2/4+0-350-FM	33
38 12 25	IP B TT 25/100/FM	16	38 51 00	PP BCD TN 25/50/LED-350	31	38 81 04	EL-T2/4+0-440-FM	33
38 12 26	IP BC TT 25/100	24	38 51 10	PP BCD TN 25/50/LED/FM-350	31	38 81 08	EL-T2/4+0-130	33
38 12 27	IP BC TT 25/100/FM	24	38 51 20	PP BC TNC 25/75-350	19	38 81 09	EL-T2/4+0-275	33
38 12 28	IP B TT1+1 25/50	16	38 51 30	PP BC TNC 25/75/FM-350	19	38 81 10	EL-T2/4+0-350	33
38 12 29	IP B TT1+1 25/50/FM	16	38 51 40	PP BC TNS 25/100-350	19	38 81 11	EL-T2/4+0-440	33
38 12 30	IP BC TT1+1 25/100	25	38 51 50	PP BC TNS 25/100/FM-350	19	38 81 15	EL-T2/3+1-130-FM	34
38 12 31	IP BC TT1+1 25/100/FM	25	38 51 60	PP BC TT 25/100-350	20	38 81 16	EL-T2/3+1-275-FM	34
38 12 32	IP B TN 60/100	16	38 51 70	PP BC TT 25/100/FM-350	20	38 81 17	EL-T2/3+1-350-FM	34

PRODUCT REGISTER

NUMERIC

Article-No.	Product	Page	Article-No.	Product	Page	Article-No.	Product	Page
38 81 18	EL-T2/3+1-440-FM	34	38 81 92	EL-T2/1+0-130	37	55 05 22	IP BC 60-350 2kV	26
38 81 22	EL-T2/3+1-130	34	38 81 93	EL-T2/1+0-275	37	55 05 23	IP BC 60/FM-350 2kV	26
38 81 23	EL-T2/3+1-275	34	38 81 94	EL-T2/1+0-350	37	80 00 23	PV DC 12.800-2	190
38 81 24	EL-T2/3+1-350	34	38 81 95	EL-T2/1+0-440	37	80 00 26	PV DC 2.800-2	181
38 81 25	EL-T2/3+1-440	35	38 81 96	EL-T2/1+0-550	37	80 00 27	PV DC 4.1000-2	189
38 81 29	EL-T2/3+0-130-FM	34	38 81 97	EL-T2/1+0-750	37	80 00 28	PV DC 9.800	190
38 81 30	EL-T2/3+0-275-FM	34	38 81 98	EL-T2/0+1-NPE	37	80 00 29	PV DC 9.1000	190
38 81 31	EL-T2/3+0-350-FM	34	39 50 02	EnerPro 1002Tr	58	80 00 30	PV DC 12.1000-2	190
38 81 32	EL-T2/3+0-440-FM	34	39 50 03	EP 1003Tr	57	80 00 31	PV AC-DC 1.1-800	188
38 81 36	EL-T2/3+0-130	34	39 50 04	EnerPro 802Tr	58	80 00 32	PV AC-DC 3.1-1000	188
38 81 37	EL-T2/3+0-275	34	39 50 05	EnerPro 802Tr/Pk	58	80 00 33	PV AC-DC 1.1-1000	188
38 81 38	EL-T2/3+0-350	34	39 50 14	EP 802/20kA-Tr	59	80 00 34	PV AC-DC 1.2-800	188
38 81 39	EL-T2/3+0-440	34	39 50 16	EP 1002/20kA-Tr	59	80 00 35	PV AC-DC 3.3-1000	188
38 81 42	EL-T2/2+1-75-FM	35	39 50 26	EP 803Tr	57	80 00 39	PV DC 3.800-3	185
38 81 43	EL-T2/2+1-130-FM	35	44 90 60	TSF 50	158	80 00 43	PV DC 3.800-3-S2	185
38 81 44	EL-T2/2+1-275-FM	35	44 90 69	TSF 100	158	80 00 56	PV DC 8.800-8	185
38 81 45	EL-T2/2+1-350-FM	35	44 90 76	TSF 50-Tr	165	80 00 82	PV DC 4.1000-2-S1	178
38 81 46	EL-T2/2+1-440-FM	35	44 90 80	TSF 100-Tr	165	80 00 92	PV DC 1/1 1xT1+2 1000V/MC4	191
38 81 47	EL-T2/2+1-550-FM	35	44 90 85	TSF 500-Tr	165	80 01 00	GAK 4/4/1xT2 800V	179
38 81 48	EL-T2/2+1-750-FM	35	44 91 75	TSF-H1	158	80 01 01	PV DC 4	189
38 81 49	EL-T2/2+1-75	35	47 21 04	SGO 70 QA	161	80 01 02	GAK 4/4/1xT2 1000V	179
38 81 50	EL-T2/2+1-130	35	47 21 05	SGO 70 QA-S	161	80 01 04	GAK 4/4/1xT1+T2 800V	179
38 81 51	EL-T2/2+1-275	35	47 21 11	SGO 350 QA	161	80 01 06	GAK 4/4/1xT1+T2 1000V	179
38 81 52	EL-T2/2+1-350	35	47 21 12	SGO 350 QA-S	161	80 01 10	GAK 8/8/1xT2 800V	180
38 81 53	EL-T2/2+1-440	35	47 21 17	SGO 70	159	80 01 12	GAK 8/8/1xT2 1000V	180
38 81 54	EL-T2/2+1-550	35	47 22 13	SGO 350	159	80 01 14	GAK 8/8/1xT1+T2 800V	180
38 81 55	EL-T2/2+1-750	35	48 78 01	TSF 500	158	80 01 16	GAK 8/8/1xT1+T2 1000V	180
38 81 57	EL-T2/2+0-130-FM	36	48 78 14	TA 100 C	160	80 01 20	GAK 2+2/2+2/2xT2 800V	181
38 81 58	EL-T2/2+0-275-FM	36	48 78 27	TA 500 C	160	80 01 22	GAK 2+2/2+2/2xT2 1000V	181
38 81 59	EL-T2/2+0-350-FM	36	48 78 30	TC 100 A	162	80 01 24	GAK 2+2/2+2/2xT1+T2 800V	181
38 81 60	EL-T2/2+0-440-FM	36	48 78 50	TC 500 A	162	80 01 25	GAK 3+3/3+3/2xT1+T2 800V	182
38 81 64	EL-T2/2+0-130	36	49 51 04	K1/500	162	80 01 26	GAK 2+2/2+2/2xT1+T2 1000V	181
38 81 65	EL-T2/2+0-275	36	49 51 05	K1/400	162	80 01 27	GAK 3+3/3+3/2xT1+T2 1000V	182
38 81 66	EL-T2/2+0-350	36	49 51 06	K1/150	162	80 01 28	GAK 3+3/3+3/2xT1+T2 800V/1000V	182
38 81 67	EL-T2/2+0-440	36	49 51 08	K1/300	162	80 01 30	GAK 6+2/6+2/2xT2 800V	183
38 81 71	EL-T2/1+1-130-FM	36	49 51 11	K1/600	162	80 01 32	GAK 6+2/6+2/2xT2 1000V	183
38 81 72	EL-T2/1+1-275-FM	36	49 51 12	K1/700	162	80 01 34	GAK 6+2/6+2/2xT1+T2 800V	183
38 81 73	EL-T2/1+1-350-FM	36	49 51 13	K1/1000	162	80 01 36	GAK 6+2/6+2/2xT1+T2 1000V	183
38 81 74	EL-T2/1+1-440-FM	36	49 51 14	K2/2000	162	80 01 40	GAK 4+4+4/4+4+4/3xT2 800V	184
38 81 78	EL-T2/1+1-130	36	53 43 72	TF 100Tr/Th-Pk	164	80 01 42	GAK 4+4+4/4+4+4/3xT2 1000V	184
38 81 79	EL-T2/1+1-275	36	53 43 85	TF 500Tr/Th-Pk	164	80 01 44	GAK 4+4+4/4+4+4/3xT1+T2 800V	184
38 81 80	EL-T2/1+1-350	36	53 43 98	TF 500-Tr	164	80 01 46	GAK 4+4+4/4+4+4/3xT1+T2 1000V	184
38 81 81	EL-T2/1+1-440	36	54 43 30	DP Koax BNC 500hm	120	80 01 48	GAK 3x1/3x1/3xT1+2 1000V	185
38 81 84	EL-T2/1+0-75-FM	37	54 43 40	DataPro Koax-8V-BNC-75 Ohm	120	80 01 49	GAK 6x1/6x1/6x T1+T2 1000V	185
38 81 85	EL-T2/1+0-130-FM	37	54 43 46	DataPro Koax-8V-BNC	120	80 01 50	GAK 9x1/9x1/9x T1+T2 1000V	185
38 81 86	EL-T2/1+0-275-FM	37	55 04 11	TF 2000Tr/Th-Pk	164	80 01 55	GAK 4+1/2xT1+T2 1000V	191
38 81 87	EL-T2/1+0-350-FM	37	55 04 40	PLPro-40A-iV	170	80 01 56	GAK 8x2/8x2/8x T1+T2 1000V-FM	185
38 81 88	EL-T2/1+0-440-FM	37	55 04 41	PLPro-80A-IV	170	80 01 57	GAK AC-3 T1+T2	187
38 81 89	EL-T2/1+0-550-FM	37	55 05 18	IP BC 60/FM	26	80 01 64	GAK 4x3/4xT1+T2 1000V-FM	185
38 81 90	EL-T2/1+0-750-FM	37	55 05 20	IP BC 60-350	26			
38 81 91	EL-T2/1+0-75	37	55 05 21	IP BC 60/FM-350	26			



Article-No.	Product	Page	Article-No.	Product	Page	Article-No.	Product	Page
80 01 65	PV DC 5.1000 T1+T2	189	96 02 48	CT PV-T2-GDT-M	56	97 00 46	MP 1x2 GDT+5V-Ad-Ad-Pg ST	78
80 01 67	PV DC 2x2 1000V/30A	186	96 02 50	CT PV-T2-1000-MS	55	97 00 47	MP 1x2 GDT+12V-Ad-Ad-Pg ST	78
80 01 68	GAK 3+3/2xT1+T2 1000 V	182	96 04 01	CT-T1+2+3/3+1-350-FM	27	97 00 48	MP 1x2 GDT+24V-Ad-Ad-Pg ST	78
80 01 69	PV DC 2x3 1000V/30A	186	96 04 05	CT-T1+2+3/3+0-350-FM	27	97 00 49	MP 1x2 GDT+36V-Ad-Ad-Pg ST	78
80 01 70	PV DC 12	190	96 04 09	CT-T1+2+3/2+0-350-FM	27	97 00 50	MP 1x2 GDT+48V-Ad-Ad-Pg ST	79
80 01 71	PV DC 9	190	96 04 13	CT-T1+2+3/2+1-350-FM	27	97 00 51	MP 1x2 GDT+60V-Ad-Ad-Pg ST	79
82 30 11	IF1	160	96 04 17	CT-T1+2+3/1+1-350-FM	28	97 00 52	MP 1x2 GDT+170V-Ad-Ad-Pg ST	79
82 30 16	IF3	160	96 04 21	CT-T1+2+3/1+0-350-FM	28	97 00 91	MP Base 2x2-R GND	71
87 00 05	LC 1	152	96 04 25	CT-T1+2+3-350-M	28	97 00 92	MP Base 2x2 GND	70
87 00 10	H35	150	97 00 00	MP Base 2x2-R	71	97 00 93	MP Base 1x2-R GND	73
87 00 30	Calibration A46	151	97 00 01	MP Base 2x2-R GDT	71	97 00 94	MP Base 1x2 GND	70
87 00 60	Measuring Adapter ADE/FGH	150	97 00 03	MP Base 2x2	70	97 00 95	MP Base 1x2-R	73
87 00 70	Measuring Adapter ADE/E	150	97 00 04	MP Base 2x2 GDT	70	97 00 96	MP Base 1x2-R GDT	73
87 01 00	A46-LSA	151	97 00 07	MP 2x2 GDT ST	70	97 00 97	MP Base 1x2	70
87 01 01	A46-VS88	151	97 00 08	MP 2x2 GDT ST-350	70	97 00 98	MP Base 1x2 GDT	70
87 01 40	Calibration H65	150	97 00 10	MP 1x2 GDT ST	70	97 00 99	MP Base 2x2-R HF	80
87 01 50	H65	150	97 00 11	MP 2x2 GDT+5V-Ad-Ad ST	71	97 01 00	MP Base 2x2-R GDT HF	80
95 15 00	MTH 90	106	97 00 12	MP 2x2 GDT+12V-Ad-Ad ST	71	97 01 01	MP Base 2x2-R GND HF	80
95 15 01	MTH 230	106	97 00 13	MP 2x2 GDT+24V-Ad-Ad ST	71	97 01 02	MP Base 1x2-R HF	80
95 15 02	MTL 90	106	97 00 14	MP 2x2 GDT+36V-Ad-Ad ST	71	97 01 03	MP Base 1x2-R GDT HF	80
95 15 03	MTL 230	106	97 00 15	MP 2x2 GDT+48V-Ad-Ad ST	72	97 01 04	MP Base 1x2-R GND HF	80
96 00 01	CT-T1+2/3+1-350-FM	17	97 00 16	MP 2x2 GDT+60V-Ad-Ad ST	72	97 10 02	MP RK-AB	86
96 00 03	CT-T1+2/3+0-350-FM	17	97 00 17	MP 2x2 GDT+170V-Ad-Ad ST	72	97 10 03	MP RK GDT	84
96 00 07	CT-T1+2/2+0-350-FM	17	97 00 18	MP 1x2 GDT+5V-Ad-Ad ST	72	97 10 04	MP RK GDT+5V-Ad-Ad	86
96 00 09	CT-T1+2/1+1-350-FM	17	97 00 19	MP 1x2 GDT+12V-Ad-Ad ST	72	97 10 05	MP RK GDT+12V-Ad-Ad	86
96 00 11	CT-T1+2/1+0-350-FM	18	97 00 20	MP 1x2 GDT+24V-Ad-Ad ST	72	97 10 06	MP RK GDT+24V-Ad-Ad	86
96 02 07	CT-T1/3+1-350-FM	10	97 00 21	MP 1x2 GDT+36V-Ad-Ad ST	72	97 10 07	MP RK GDT+36V-Ad-Ad	86
96 02 09	CT-T1/3+0-350-FM	10	97 00 22	MP 1x2 GDT+48V-Ad-Ad ST	73	97 10 08	MP RK GDT+48V-Ad-Ad	87
96 02 13	CT-T1/2+0-350-FM	10	97 00 23	MP 1x2 GDT+60V-Ad-Ad ST	73	97 10 09	MP RK GDT+60V-Ad-Ad	87
96 02 15	CT-T1/1+1-350-FM	10	97 00 24	MP 1x2 GDT+170V-Ad-Ad ST	73	97 10 10	MP RK GDT+170V-Ad-Ad	87
96 02 17	CT-T1/1+0-350-FM	11	97 00 25	MP 2x2 GDT+5V-Ad-Pg ST	74	97 10 11	MP RK GDT+5V-Ad-Pg	87
96 02 20	CT PV-T2/2-0/600	55	97 00 26	MP 2x2 GDT+12V-Ad-Pg ST	74	97 10 12	MP RK GDT+12V-Ad-Pg	87
96 02 21	CT PV-T2/2-0/600-FM	55	97 00 27	MP 2x2 GDT+24V-Ad-Pg ST	74	97 10 13	MP RK GDT+24V-Ad-Pg	87
96 02 22	CT PV-T2/2-0/1000	55	97 00 28	MP 2x2 GDT+36V-Ad-Pg ST	74	97 10 14	MP RK GDT+36V-Ad-Pg	87
96 02 23	CT PV-T2/2-0/1000-FM	55	97 00 29	MP 2x2 GDT+48V-Ad-Pg ST	75	97 10 15	MP RK GDT+48V-Ad-Pg	88
96 02 24	CT PV-T2/2+1/600	55	97 00 30	MP 2x2 GDT+60V-Ad-Pg ST	75	97 10 16	MP RK GDT+60V-Ad-Pg	88
96 02 25	CT PV-T2/2+1/600-FM	55	97 00 31	MP 2x2 GDT+170V-Ad-Pg ST	75	97 10 17	MP RK GDT+170V-Ad-Pg	88
96 02 26	CT PV-T2/2+1/1000	55	97 00 32	MP 1x2 GDT+5V-Ad-Pg ST	75	97 10 18	MP RK GDT+5V-Ad-Ad-Pg	85
96 02 27	CT PV-T2/2+1/1000-FM	55	97 00 33	MP 1x2 GDT+12V-Ad-Pg ST	75	97 10 19	MP RK GDT+12V-Ad-Ad-Pg	85
96 02 28	CT PV-T2/2+GDT/600	56	97 00 34	MP 1x2 GDT+24V-Ad-Pg ST	75	97 10 20	MP RK GDT+24V-Ad-Ad-Pg	85
96 02 29	CT PV-T2/2+GDT/600-FM	56	97 00 35	MP 1x2 GDT+36V-Ad-Pg ST	75	97 10 21	MP RK GDT+36V-Ad-Ad-Pg	85
96 02 30	CT PV-T2/2+GDT/1000	56	97 00 36	MP 1x2 GDT+48V-Ad-Pg ST	76	97 10 22	MP RK GDT+48V-Ad-Ad-Pg	86
96 02 31	CT PV-T2/2+GDT/1000-FM	56	97 00 37	MP 1x2 GDT+60V-Ad-Pg ST	76	97 10 23	MP RK GDT+60V-Ad-Ad-Pg	86
96 02 33	CT-T1/0+1-FS-FM	11	97 00 38	MP 1x2 GDT+170V-Ad-Pg ST	76	97 10 24	MP RK GDT+170V-Ad-Ad-Pg	86
96 02 36	CT-T1+2-350-M	18	97 00 39	MP 2x2 GDT+5V-Ad-Ad-Pg ST	77	97 10 25	MP RK 5V-Ad-Ad	89
96 02 37	CT-T1-350-M	11	97 00 40	MP 2x2 GDT+12V-Ad-Ad-Pg ST	77	97 10 26	MP RK 12V-Ad-Ad	89
96 02 37	CT-T1-350-M	11	97 00 41	MP 2x2 GDT+24V-Ad-Ad-Pg ST	77	97 10 27	MP RK 24V-Ad-Ad	89
96 02 38	CT-T1-NPE-M	11	97 00 42	MP 2x2 GDT+36V-Ad-Ad-Pg ST	77	97 10 28	MP RK 36V-Ad-Ad	89
96 02 38	CT-T1-NPE-M	18	97 00 43	MP 2x2 GDT+48V-Ad-Ad-Pg ST	78	97 10 29	MP RK 48V-Ad-Ad	90
96 02 46	CT PV-T2-600-M	55	97 00 44	MP 2x2 GDT+60V-Ad-Ad-Pg ST	78	97 10 30	MP RK 60V-Ad-Ad	90
96 02 47	CT PV-T2-1000-M	55	97 00 45	MP 2x2 GDT+170V-Ad-Ad-Pg ST	78	97 10 31	MP RK 170V-Ad-Ad	90



PRODUCT REGISTER NUMERIC

Article-No.	Product	Page
97 10 32	MP RK 5V-Ad-Pg	90
97 10 33	MP RK 12V-Ad-Pg	90
97 10 34	MP RK 24V-Ad-Pg	90
97 10 35	MP RK 36V-Ad-Pg	90
97 10 36	MP RK 48V-Ad-Pg	91
97 10 37	MP RK 60V-Ad-Pg	91
97 10 38	MP RK 170V-Ad-Pg	91
97 10 39	MP RK 5V-Ad-Ad-Pg	91
97 10 40	MP RK 12V-Ad-Ad-Pg	91
97 10 41	MP RK 24V-Ad-Ad-Pg	91
97 10 42	MP RK 36V-Ad-Ad-Pg	91
97 10 43	MP RK 48V-Ad-Ad-Pg	92
97 10 44	MP RK 60V-Ad-Ad-Pg	92
97 10 45	MP RK 170V-Ad-Ad-Pg	92
97 10 50	MP 2x2 5V-HF ST	80
97 10 51	MP 2x2 24V-HF ST	80
97 10 52	MP 1x2 5V-HF ST	80
97 10 53	MP 1x2 24V-HF ST	80
97 10 54	MP 2x2 5V-170-HF ST	81
97 10 55	MP 2x2 24V-170-HF ST	81
97 10 56	MP 1x2 5V-170-HF ST	81
97 10 57	MP 1x2 24V-170-HF ST	81
97 20 11	MSR-M20-24V	93
97 20 12	MSR-M20-24V-Fine	93



Product	Article-No.	Page	Product	Article-No.	Page	Product	Article-No.	Page
A46-LSA	87 01 00	151	CT-T1+2+3/3+1-350-FM	96 04 01	27	DP 1LSA-C24FS-PTC	24 00 66	111
A46-VS88	87 01 01	151	CT-T1+2+3-350-M	96 04 25	28	DP 1LSA-C48FS-PTC	24 00 61	112
AK35 GDT230	17 01 00	60	CT-T1+2-350-M	96 02 36	18	DP 1LSA-C5FS-PTC	24 00 63	111
AntPro 5,8GHz-R-SMA	04 58 02	121	CT-T1-350-M	96 02 37	11	DP 1LSA-C60FS-PTC	24 00 62	112
AntPro 5,8GHz-SMA	04 58 00	121	CT-T1-350-M	96 02 37	11	DP 1LSA-T110FS-PTC	24 00 48	110
AntPro 6GHz-N(f/f)	04 00 11	126	CT-T1-NPE-M	96 02 38	11	DP 1LSA-TK180FS	24 00 49	110
AntPro 6GHz-N(m/f)	04 00 10	126	CT-T1-NPE-M	96 02 38	18	DP 1x8RJ45-19"	19 40 13	100
AntPro Koax-GSM-N/230	04 00 01	125	DAK 2x 16	17 01 10	192	DP 1xRJ45-PoE-Alu	24 00 21	99
AntPro Koax-GSM-N/230(f/f)	04 00 04	125	DataPro 2x1-24V-SDSL-Tr	24 00 24	82	DP 2x1-12V/12V-0,3Ω -Tr	26 12 12	141
AntPro Lambda/4 7/16 0.42GHz	04 04 25	123	DataPro 2x1-SDSL-Tr	24 00 18	82	DP 2x1-24V/24V-0,3Ω -Tr	26 24 24	141
AntPro Lambda/4 7/16 TRI	04 00 30	123	DataPro 4x1-SDSL-Tr	24 00 20	82	DP 2x1-30V/30V-0,3Ω -Tr	26 30 30	141
AntPro Lambda/4 7/16 TRI (f/f)	04 00 31	123	DataPro ISDN-aP	24 00 13	102	DP 2x1-36V/36V-0,3Ω -Tr	26 36 36	141
AntPro Lambda/4 N 0.51GHz	04 00 20	122	DataPro Koax-8V-BNC	54 43 46	120	DP 2x1-60V/60V-0,3Ω -Tr	26 60 60	141
AntPro Lambda/4 N 0.51GHz (f/f)	04 00 21	122	DataPro Koax-8V-BNC-75 Ohm	54 43 40	120	DP 2x1-RLC/50V-Tr	28 70 50	142
AntPro Lambda/4 N 0.8GHz	04 00 22	122	DataPro Z-12V/12V	22 12 12	144	DP 2x1-RLC-Tr	27 00 00	142
AntPro Lambda/4 N 2.0GHz	04 00 23	122	DataPro Z-15V/15V	22 15 15	144	DP 2x8-36V/36V-Tr/GO	27 90 00	143
AntPro Lambda/4 N 2.0GHz (f/f)	04 00 24	122	DataPro Z-24V/24V	22 24 24	144	DP 2x8-36V/36V-Tr/GU	27 90 01	143
Calibration A46	87 00 30	151	DataPro Z-30V/30V	22 30 30	145	DP 2x8RJ45-19"	19 40 23	100
Calibration H65	87 01 40	150	DataPro Z-36V/36V	22 36 36	145	DP 3x8RJ45-19"	19 40 33	100
CT PV-T2/2+1/1000	96 02 26	55	DataPro Z-48V/48V	22 48 48	145	DP 4x8RJ45-19"	19 40 43	100
CT PV-T2/2+1/1000-FM	96 02 27	55	DataPro Z-60V/60V	22 60 60	145	DP 5x8RJ45-19"	19 40 53	101
CT PV-T2/2+1/600	96 02 24	55	DataPro Z-6V/6V	22 06 06	144	DP 6x8RJ45-19"	19 40 63	101
CT PV-T2/2+1/600-FM	96 02 25	55	DataPro Z-RLC	23 00 00	145	DP 8xRJ45-6V-WG	19 40 50	101
CT PV-T2/2+GDT/1000	96 02 30	56	DataPro-Radio/TV	21 00 30	127	DP FME-AD	16 05 20	121
CT PV-T2/2+GDT/1000-FM	96 02 31	56	DataPro-RJ45-48V-Tr	23 90 00	98	DP Koax 7/16	10 10 00	124
CT PV-T2/2+GDT/600	96 02 28	56	DataPro-SAT	21 00 20	127	DP Koax 7/16 (f/f)	10 10 01	124
CT PV-T2/2+GDT/600-FM	96 02 29	56	DataPro-TAE/NFN-aP	24 00 04	102	DP Koax BNC 500hm	54 43 30	120
CT PV-T2/2-0/1000	96 02 22	55	DP 10LSA-110	24 01 40	113	DP RJ45 f/f	24 00 11	99
CT PV-T2/2-0/1000-FM	96 02 23	55	DP 10LSA-12V	24 00 25	113	DP RJ45-CAT6-48V-Tr	24 00 05	98
CT PV-T2/2-0/600	96 02 20	55	DP 10LSA-24V	24 00 27	113	DP2-2MB-Tr	24 00 17	143
CT PV-T2/2-0/600-FM	96 02 21	55	DP 10LSA-PTC 110	24 01 42	114	DP2x1-12V/12V-Tr	27 12 12	137
CT PV-T2-1000-M	96 02 47	55	DP 10LSA-PTC-12V	24 00 26	114	DP2x1-150V/150V-Tr	27 04 04	138
CT PV-T2-1000-MS	96 02 50	55	DP 10LSA-PTC-24V	24 00 28	114	DP2x1-15V/15V-Tr	27 15 15	137
CT PV-T2-600-M	96 02 46	55	DP 1LSA-110	24 00 39	109	DP2x1-24V/24V-Tr	27 24 24	137
CT PV-T2-GDT-M	96 02 48	56	DP 1LSA-110-PTC	24 00 46	110	DP2x1-30V/30V-Tr	27 30 30	138
CT-T1/0+1-FS-FM	96 02 33	11	DP 1LSA-12	24 00 32	108	DP2x1-36V/36V-Tr	27 36 36	138
CT-T1/1+0-350-FM	96 02 17	11	DP 1LSA-12-PTC	24 00 41	109	DP2x1-48V/48V-Tr	27 48 48	138
CT-T1/1+1-350-FM	96 02 15	10	DP 1LSA-15	24 00 33	108	DP2x1-60V/60V-Tr	27 60 60	138
CT-T1/2+0-350-FM	96 02 13	10	DP 1LSA-15-PTC	24 00 42	109	DP2x1-6V/6V-Tr	27 06 06	137
CT-T1/3+0-350-FM	96 02 09	10	DP 1LSA-180FS	24 00 47	110	DP2x1-80V/80V-Tr	27 80 80	138
CT-T1/3+1-350-FM	96 02 07	10	DP 1LSA-24	24 00 34	108	DP3x1-12V/12V-Tr	28 12 12	139
CT-T1+2/1+0-350-FM	96 00 11	18	DP 1LSA-24-PTC	24 00 43	109	DP3x1-150V/150V-Tr	28 04 04	140
CT-T1+2/1+1-350-FM	96 00 09	17	DP 1LSA-30	24 00 36	109	DP3x1-15V/15V-Tr	28 15 15	139
CT-T1+2/2+0-350-FM	96 00 07	17	DP 1LSA-48	24 00 37	109	DP3x1-24V/24V-Tr	28 24 24	139
CT-T1+2/3+0-350-FM	96 00 03	17	DP 1LSA-48-PTC	24 00 44	110	DP3x1-30V/30V-Tr	28 30 30	139
CT-T1+2/3+1-350-FM	96 00 01	17	DP 1LSA-5	24 00 31	108	DP3x1-36V/36V-Tr	28 36 36	140
CT-T1+2+3/1+0-350-FM	96 04 21	28	DP 1LSA-5-PTC	24 00 40	109	DP3x1-48V/48V-Tr	28 48 48	140
CT-T1+2+3/1+1-350-FM	96 04 17	28	DP 1LSA-60	24 00 38	109	DP3x1-60/60V-Tr	28 60 60	140
CT-T1+2+3/2+0-350-FM	96 04 09	27	DP 1LSA-60-PTC	24 00 45	110	DP-8xRJ45-6x6V/2x48V-WG	19 40 51	101
CT-T1+2+3/2+1-350-FM	96 04 13	27	DP 1LSA-C12FS-PTC	24 00 64	111	DP-RS 485-Tr	27 04 85	83
CT-T1+2+3/3+0-350-FM	96 04 05	27	DP 1LSA-C15FS-PTC	24 00 65	111	EL-T2/0+1-NPE	38 81 98	37

PRODUCT REGISTER

ALPHABETICAL

Product	Article-No.	Page	Product	Article-No.	Page	Product	Article-No.	Page
EL-T2/1+0-130	38 81 92	37	EL-T2/3+0-440-FM	38 81 32	34	EnerPro 802Tr/Pk	39 50 05	58
EL-T2/1+0-130-FM	38 81 85	37	EL-T2/3+1-130	38 81 22	34	EP 1002/20kA-Tr	39 50 16	59
EL-T2/1+0-275	38 81 93	37	EL-T2/3+1-130-FM	38 81 15	34	EP 1003Tr	39 50 03	57
EL-T2/1+0-275-FM	38 81 86	37	EL-T2/3+1-275	38 81 23	34	EP 12V-20A/LED	24 12 03	52
EL-T2/1+0-350	38 81 94	37	EL-T2/3+1-275-FM	38 81 16	34	EP 24V-20A/LED	24 24 03	52
EL-T2/1+0-350-FM	38 81 87	37	EL-T2/3+1-350	38 81 24	34	EP 36V-20A/LED	24 36 03	52
EL-T2/1+0-440	38 81 95	37	EL-T2/3+1-350-FM	38 81 17	34	EP 48V-20A/LED	24 48 03	52
EL-T2/1+0-440-FM	38 81 88	37	EL-T2/3+1-440	38 81 25	35	EP 802/20kA-Tr	39 50 14	59
EL-T2/1+0-550	38 81 96	37	EL-T2/3+1-440-FM	38 81 18	34	EP 803Tr	39 50 26	57
EL-T2/1+0-550-FM	38 81 89	37	EL-T2/4+0-130	38 81 08	33	EP C IT 2P	38 15 00	41
EL-T2/1+0-75	38 81 91	37	EL-T2/4+0-130-FM	38 81 01	33	EP C IT 2P/FM	38 15 01	41
EL-T2/1+0-750	38 81 97	37	EL-T2/4+0-275	38 81 09	33	EP C IT 3P 440	38 15 10	41
EL-T2/1+0-750-FM	38 81 90	37	EL-T2/4+0-275-FM	38 81 02	33	EP C IT 3P 440/FM	38 15 11	41
EL-T2/1+0-75-FM	38 81 84	37	EL-T2/4+0-350	38 81 10	33	EP C TN 275	38 12 47	40
EL-T2/1+1-130	38 81 78	36	EL-T2/4+0-350-FM	38 81 03	33	EP C TN 275/FM	38 12 48	40
EL-T2/1+1-130-FM	38 81 71	36	EL-T2/4+0-440	38 81 11	33	EP C TN 275-D	38 12 52	40
EL-T2/1+1-275	38 81 79	36	EL-T2/4+0-440-FM	38 81 04	33	EP C TN 350	38 55 40	40
EL-T2/1+1-275-FM	38 81 72	36	EL-T2-130-M	38 80 01	33	EP C TN 350/FM	38 55 50	40
EL-T2/1+1-350	38 81 80	36	EL-T2-275-M	38 80 02	33	EP C TN 75	38 14 00	40
EL-T2/1+1-350-FM	38 81 73	36	EL-T2-350-M	38 80 03	33	EP C TN 75/FM	38 14 05	40
EL-T2/1+1-440	38 81 81	36	EL-T2-440-M	38 80 04	33	EP C TNC 275	38 11 76	38
EL-T2/1+1-440-FM	38 81 74	36	EL-T2-550-M	38 80 05	33	EP C TNC 275/FM	38 11 77	38
EL-T2/2+0-130	38 81 64	36	EL-T2-750-M	38 80 06	33	EP C TNC 350	38 55 60	38
EL-T2/2+0-130-FM	38 81 57	36	EL-T2-75-M	38 80 00	33	EP C TNC 350/FM	38 55 70	38
EL-T2/2+0-275	38 81 65	36	EL-T2-NPE-M	38 80 07	33	EP C TNS 275	38 11 78	38
EL-T2/2+0-275-FM	38 81 58	36	E-Membran M12	17 01 40	192	EP C TNS 275/FM	38 11 79	38
EL-T2/2+0-350	38 81 66	36	EMV-FKL	26 09 90	73	EP C TNS 350	38 55 80	38
EL-T2/2+0-350-FM	38 81 59	36	EnerPro 1002Tr	39 50 02	58	EP C TNS 350/FM	38 55 90	38
EL-T2/2+0-440	38 81 67	36	EnerPro 12V-6A/LED	24 12 02	51	EP C TT 275	38 11 80	39
EL-T2/2+0-440-FM	38 81 60	36	EnerPro 12V-Tr	24 12 00	53	EP C TT 275/FM	38 11 81	39
EL-T2/2+1-130	38 81 50	35	EnerPro 150Tr/Pk	38 20 25	48	EP C TT 350	38 56 00	39
EL-T2/2+1-130-FM	38 81 43	35	EnerPro 220Tr/20kA	38 20 22	47	EP C TT 350/FM	38 56 10	39
EL-T2/2+1-275	38 81 51	35	EnerPro 220Tr/20kA/PK	38 20 23	47	EP C TT1+1 275	38 11 82	39
EL-T2/2+1-275-FM	38 81 44	35	EnerPro 230 SDU	24 00 02	49	EP C TT1+1 275/FM	38 11 83	39
EL-T2/2+1-350	38 81 52	35	EnerPro 24V-6A/LED	24 24 02	51	EP C TT1+1 350	38 11 88	39
EL-T2/2+1-350-FM	38 81 45	35	EnerPro 24V-Tr	24 24 00	53	EP C TT1+1 350/FM	38 11 91	39
EL-T2/2+1-440	38 81 53	35	EnerPro 280Tr	38 20 28	40	EP C TT2+1-110	38 09 10	39
EL-T2/2+1-440-FM	38 81 46	35	EnerPro 280Tr/Pk	38 20 29	40	EP C TT2+1-110/FM	38 09 11	39
EL-T2/2+1-550	38 81 54	35	EnerPro 282Tr-M	38 20 44	42	EP CV 2P 100V/63A/FM-LED	38 20 87	171
EL-T2/2+1-550-FM	38 81 47	35	EnerPro 282Tr-M/Pk	38 20 45	42	EP CV 2P 100V/63A-LED	38 20 86	171
EL-T2/2+1-75	38 81 49	35	EnerPro 284Tr-M	38 20 42	42	EP CV 2P 65V/63A/FM-LED	38 20 83	171
EL-T2/2+1-750	38 81 55	35	EnerPro 284Tr-M/Pk	38 20 43	42	EP CV 2P 65V/63A-LED	38 20 80	171
EL-T2/2+1-750-FM	38 81 48	35	EnerPro 36V-6A/LED	24 36 02	51	EP D 230 KM	36 20 35	48
EL-T2/2+1-75-FM	38 81 42	35	EnerPro 36V-Tr	24 36 00	53	EP D IT 2P	38 05 70	44
EL-T2/3+0-130	38 81 36	34	EnerPro 48V/100A-Tr	38 20 70	50	EP D IT 2P/FM	38 05 71	44
EL-T2/3+0-130-FM	38 81 29	34	EnerPro 48V/100A-Tr/Pk	38 20 71	50	EP D IT 3P	38 05 76	44
EL-T2/3+0-275	38 81 37	34	EnerPro 48V-Tr	24 48 00	53	EP D IT 3P/FM	38 05 77	44
EL-T2/3+0-275-FM	38 81 30	34	EnerPro 60 V-Tr	24 60 00	53	EP D TN 120V/16A	38 05 59	45
EL-T2/3+0-350	38 81 38	34	EnerPro 65V/12A-Tr	29 60 00	171	EP D TN 120V/16A/FM	38 05 60	45
EL-T2/3+0-350-FM	38 81 31	34	EnerPro 65V/12A-Tr/FM	29 60 02	171	EP D TN 120V/25A	38 05 66	46
EL-T2/3+0-440	38 81 39	34	EnerPro 802Tr	39 50 04	58	EP D TN 120V/25A-FM	38 05 67	46



Product	Article-No.	Page	Product	Article-No.	Page	Product	Article-No.	Page
EP D TN 230V/16A	38 05 62	46	GAK 3x1/3x1/3xT1+2 1000V	80 01 48	185	IP BC 60	37 38 30	26
EP D TN 230V/16A/FM	38 05 63	46	GAK 4/4/1xT1+T2 1000V	80 01 06	179	IP BC 60/FM	55 05 18	26
EP D TN 230V/25A	38 05 68	47	GAK 4/4/1xT1+T2 800V	80 01 04	179	IP BC 60/FM-350	55 05 21	26
EP D TN 230V/25A-FM	38 05 69	47	GAK 4/4/1xT2 1000V	80 01 02	179	IP BC 60/FM-350 2kV	55 05 23	26
EP D TN 24V/16A	38 05 50	45	GAK 4/4/1xT2 800V	80 01 00	179	IP BC 60-350	55 05 20	26
EP D TN 24V/16A/FM	38 05 51	45	GAK 4+1/2xT1+T2 1000V	80 01 55	191	IP BC 60-350 2kV	55 05 22	26
EP D TN 24V/25A	38 05 52	46	GAK 4+4+4/4+4+4/3xT1+T2 1000V	80 01 46	184	IP BC TN 25/50	38 12 38	25
EP D TN 24V/25A-FM	38 05 55	46	GAK 4+4+4/4+4+4/3xT1+T2 800V	80 01 44	184	IP BC TN 25/50/FM	38 12 39	25
EP D TN 275	38 12 54	46	GAK 4+4+4/4+4+4/3xT2 1000V	80 01 42	184	IP BC TN 25/50/FM-350	38 54 30	25
EP D TN 275/FM	38 12 55	46	GAK 4+4+4/4+4+4/3xT2 800V	80 01 40	184	IP BC TN 25/50-350	38 54 20	25
EP D TN 275V/25A	38 05 61	47	GAK 4x3/4xT1+T2 1000V-FM	80 01 64	185	IP BC TN 60/100	38 12 34	25
EP D TN 275V/25A-FM	38 05 48	47	GAK 6+2/6+2/2xT1+T2 1000V	80 01 36	183	IP BC TN 60/100/FM	38 12 35	25
EP D TN 48V/16A	38 05 53	45	GAK 6+2/6+2/2xT1+T2 800V	80 01 34	183	IP BC TN 60/100/FM-350	38 54 10	25
EP D TN 48V/16A/FM	38 05 54	45	GAK 6+2/6+2/2xT2 1000V	80 01 32	183	IP BC TN 60/100-350	38 54 00	25
EP D TN 48V/25A	38 05 49	46	GAK 6+2/6+2/2xT2 800V	80 01 30	183	IP BC TNC 25/75	38 12 18	24
EP D TN 48V/25A-FM	38 05 58	46	GAK 6x1/6x1/6x T1+T2 1000V	80 01 49	185	IP BC TNC 25/75/FM	38 12 19	24
EP D TN 60V/16A	38 05 56	45	GAK 8/8/1xT1+T2 1000V	80 01 16	180	IP BC TNC 25/75/FM-350	38 53 10	24
EP D TN 60V/16A/FM	38 05 57	45	GAK 8/8/1xT1+T2 800V	80 01 14	180	IP BC TNC 25/75-350	38 53 00	24
EP D TN 60V/25A	38 05 64	46	GAK 8/8/1xT2 1000V	80 01 12	180	IP BC TNC 60/100	38 11 42	24
EP D TN 60V/25A-FM	38 05 65	46	GAK 8/8/1xT2 800V	80 01 10	180	IP BC TNC 60/100/FM	38 11 43	24
EP D TNC 275	38 05 24	43	GAK 8x2/8x2/8x T1+T2 1000V-FM	80 01 56	185	IP BC TNC 60/100/FM -350	38 52 90	24
EP D TNC 275/FM	38 05 25	43	GAK 9x1/9x1/9x T1+T2 1000V	80 01 50	185	IP BC TNC 60/100-350	38 52 80	24
EP D TNS 275	38 05 30	43	GAK AC-3 T1+T2	80 01 57	187	IP BC TNS 25/100	38 12 22	23
EP D TNS 275/FM	38 05 31	43	H35	87 00 10	150	IP BC TNS 25/100/FM	38 12 23	23
EP D TT 275	38 05 35	43	H45	16 02 00	150	IP BC TNS 25/100/FM-350	38 53 50	23
EP D TT 275/FM	38 05 36	43	H65	87 01 50	150	IP BC TNS 25/100-350	38 53 40	23
EP D TT1+1 275	38 05 38	43	IF1	82 30 11	160	IP BC TNS 60/100	38 11 47	23
EP D TT1+1 275/FM	38 05 39	43	IF3	82 30 16	160	IP BC TNS 60/100/FM	38 11 48	23
EP D TT2+1 275	38 05 40	43	IP B TN 25/50	38 12 36	16	IP BC TNS 60/100/FM-350	38 53 30	23
EP D TT2+1 275/FM	38 05 41	43	IP B TN 25/50/FM	38 12 37	16	IP BC TNS 60/100-350	38 53 20	23
EPF 230/400V/100A-E	25 31 40	135	IP B TN 60/100	38 12 32	16	IP BC TT 25/100	38 12 26	24
EPF 230/400V/16A-W	25 30 45	134	IP B TN 60/100/FM	38 12 33	16	IP BC TT 25/100/FM	38 12 27	24
EPF 230/400V/200A-E	25 31 60	135	IP B TNC 25/75	38 12 16	15	IP BC TT 25/100/FM-350	38 53 90	24
EPF 230/400V/25A-W	25 30 80	134	IP B TNC 25/75/FM	38 12 17	15	IP BC TT 25/100-350	38 53 80	24
EPF 230/400V/35A-W	25 31 00	134	IP B TNC 60/100	38 11 40	15	IP BC TT 60/100	38 11 52	24
EPF 230/400V/63A-E	25 31 30	135	IP B TNC 60/100/FM	38 11 41	15	IP BC TT 60/100/FM	38 11 54	24
EPF 230V/16A-S	25 30 20	133	IP B TNS 25/100	38 12 20	15	IP BC TT 60/100/FM-350	38 53 70	24
EPF 230V/16A-Tr	25 30 16	132	IP B TNS 25/100/FM	38 12 21	15	IP BC TT 60/100-350	38 53 60	24
EPF 230V/16A-W	25 30 25	133	IP B TNS 60/100	38 11 45	15	IP BC TT 60/100-LED	38 11 53	26
EPF 230V/25A-Tr	25 30 17	132	IP B TNS 60/100/FM	38 11 46	15	IP BC TT 60/100-LED/FM	38 11 63	26
EPF 230V/35A-S	25 30 85	133	IP B TT 25/100	38 12 24	16	IP BC TT1+1 25/100	38 12 30	25
EPF 48V/25A-S	25 30 53	133	IP B TT 25/100/FM	38 12 25	16	IP BC TT1+1 25/100/FM	38 12 31	25
EPF 60V/16A-S	25 30 22	133	IP B TT 60/100	38 11 50	16	IP BC TT1+1 25/100/FM-350	38 54 70	25
GAK 2+2/2+2/2xT1+T2 1000V	80 01 26	181	IP B TT 60/100/FM	38 11 51	16	IP BC TT1+1 25/100-350	38 54 60	25
GAK 2+2/2+2/2xT1+T2 800V	80 01 24	181	IP B TT1+1 25/50	38 12 28	16	IP BC TT1+1 60/100	38 11 57	25
GAK 2+2/2+2/2xT2 1000V	80 01 22	181	IP B TT1+1 25/50/FM	38 12 29	16	IP BC TT1+1 60/100/FM	38 11 58	25
GAK 2+2/2+2/2xT2 800V	80 01 20	181	IP B TT1+1 60/100	38 11 55	16	IP BC TT1+1 60/100/FM-350	38 54 50	25
GAK 3+3/2xT1+T2 1000 V	80 01 68	182	IP B TT1+1 60/100/FM	38 11 56	16	IP BC TT1+1 60/100-350	38 54 40	25
GAK 3+3/3+3/2xT1+T2 1000V	80 01 27	182	IP BC 25	37 38 25	26	IP BC TT1+1 60/100-LED	38 11 59	26
GAK 3+3/3+3/2xT1+T2 800V	80 01 25	182	IP BC 25/FM	37 38 26	26	IP BC TT2+1 60/100-LED	38 11 60	26
GAK 3+3/3+3/2xT1+T2 800V/1000V	80 01 28	182				IP BC TT2+1 60/100-LED/FM	38 11 61	26

PRODUCT REGISTER

ALPHABETICAL

Product	Article-No.	Page
IsoProData 150V/150V-Tr	27 03 03	136
IsoProData-Tr	27 30 02	84
K1/1000	49 51 13	162
K1/150	49 51 06	162
K1/300	49 51 08	162
K1/400	49 51 05	162
K1/500	49 51 04	162
K1/600	49 51 11	162
K1/700	49 51 12	162
K2/2000	49 51 14	162
KA 1TE-1/2	17 00 15	60
KA 1TE-1/3	17 00 13	60
KA 1TE-1/6	17 00 31	60
KA 1TE-1/8	17 00 42	60
KA 2TE-1/4	17 00 25	60
KA 2TE-1/4	17 00 41	60
LC 1	87 00 05	152
LSA 2/10 AD	24 01 09	115
LSA 2/10 KS-120	24 01 36	115
LSA 2/10 KSR	24 01 08	115
LSA 2/10-AN	24 01 00	115
LSA 2/10-ER38-rot	24 01 04	115
LSA 2/10-ES	24 01 33	115
LSA 2/10-MW10-25/22	24 01 10	115
LSA 2/10-TR	24 01 02	115
LSA DIN ADAPT	24 01 37	115
Measuring Adapter ADE/E	87 00 70	150
Measuring Adapter ADE/FGH	87 00 60	150
MP 1x2 24V-170-HF ST	97 10 57	81
MP 1x2 24V-HF ST	97 10 53	80
MP 1x2 5V-170-HF ST	97 10 56	81
MP 1x2 5V-HF ST	97 10 52	80
MP 1x2 GDT ST	97 00 10	70
MP 1x2 GDT+12V-Ad-Ad ST	97 00 19	72
MP 1x2 GDT+12V-Ad-Ad-Pg ST	97 00 47	78
MP 1x2 GDT+12V-Ad-Pg ST	97 00 33	75
MP 1x2 GDT+170V-Ad-Ad ST	97 00 24	73
MP 1x2 GDT+170V-Ad-Ad-Pg ST	97 00 52	79
MP 1x2 GDT+170V-Ad-Pg ST	97 00 38	76
MP 1x2 GDT+24V-Ad-Ad ST	97 00 20	72
MP 1x2 GDT+24V-Ad-Ad-Pg ST	97 00 48	78
MP 1x2 GDT+24V-Ad-Pg ST	97 00 34	75
MP 1x2 GDT+36V-Ad-Ad ST	97 00 21	72
MP 1x2 GDT+36V-Ad-Ad-Pg ST	97 00 49	78
MP 1x2 GDT+36V-Ad-Pg ST	97 00 35	75
MP 1x2 GDT+48V-Ad-Ad ST	97 00 22	73
MP 1x2 GDT+48V-Ad-Ad-Pg ST	97 00 50	79
MP 1x2 GDT+48V-Ad-Pg ST	97 00 36	76
MP 1x2 GDT+5V-Ad-Ad ST	97 00 18	72
MP 1x2 GDT+5V-Ad-Ad-Pg ST	97 00 46	78
MP 1x2 GDT+5V-Ad-Pg ST	97 00 32	75

Product	Article-No.	Page
MP 1x2 GDT+60V-Ad-Ad ST	97 00 23	73
MP 1x2 GDT+60V-Ad-Ad-Pg ST	97 00 51	79
MP 1x2 GDT+60V-Ad-Pg ST	97 00 37	76
MP 2x2 24V-170-HF ST	97 10 55	81
MP 2x2 24V-HF ST	97 10 51	80
MP 2x2 5V-170-HF ST	97 10 54	81
MP 2x2 5V-HF ST	97 10 50	80
MP 2x2 GDT ST	97 00 07	70
MP 2x2 GDT ST-350	97 00 08	70
MP 2x2 GDT+12V-Ad-Ad ST	97 00 12	71
MP 2x2 GDT+12V-Ad-Ad-Pg ST	97 00 40	77
MP 2x2 GDT+12V-Ad-Pg ST	97 00 26	74
MP 2x2 GDT+170V-Ad-Ad ST	97 00 17	72
MP 2x2 GDT+170V-Ad-Ad-Pg ST	97 00 45	78
MP 2x2 GDT+170V-Ad-Pg ST	97 00 31	75
MP 2x2 GDT+24V-Ad-Ad ST	97 00 13	71
MP 2x2 GDT+24V-Ad-Ad-Pg ST	97 00 41	77
MP 2x2 GDT+24V-Ad-Pg ST	97 00 27	74
MP 2x2 GDT+36V-Ad-Ad ST	97 00 14	71
MP 2x2 GDT+36V-Ad-Ad-Pg ST	97 00 42	77
MP 2x2 GDT+36V-Ad-Pg ST	97 00 28	74
MP 2x2 GDT+48V-Ad-Ad ST	97 00 15	72
MP 2x2 GDT+48V-Ad-Ad-Pg ST	97 00 43	78
MP 2x2 GDT+48V-Ad-Pg ST	97 00 29	75
MP 2x2 GDT+5V-Ad-Ad ST	97 00 11	71
MP 2x2 GDT+5V-Ad-Ad-Pg ST	97 00 39	77
MP 2x2 GDT+5V-Ad-Pg ST	97 00 25	74
MP 2x2 GDT+60V-Ad-Ad ST	97 00 16	72
MP 2x2 GDT+60V-Ad-Ad-Pg ST	97 00 44	78
MP 2x2 GDT+60V-Ad-Pg ST	97 00 30	75
MP Base 1x2	97 00 97	70
MP Base 1x2 GDT	97 00 98	70
MP Base 1x2 GND	97 00 94	70
MP Base 1x2-R	97 00 95	73
MP Base 1x2-R GDT	97 00 96	73
MP Base 1x2-R GDT HF	97 01 03	80
MP Base 1x2-R GND	97 00 93	73
MP Base 1x2-R GND HF	97 01 04	80
MP Base 1x2-R HF	97 01 02	80
MP Base 2x2	97 00 03	70
MP Base 2x2 GDT	97 00 04	70
MP Base 2x2 GND	97 00 92	70
MP Base 2x2-R	97 00 00	71
MP Base 2x2-R GDT	97 00 01	71
MP Base 2x2-R GDT HF	97 01 00	80
MP Base 2x2-R GND	97 00 91	71
MP Base 2x2-R GND HF	97 01 01	80
MP Base 2x2-R HF	97 00 99	80
MP RK 12V-Ad-Ad	97 10 26	89
MP RK 12V-Ad-Ad-Pg	97 10 40	91
MP RK 12V-Ad-Pg	97 10 33	90

Product	Article-No.	Page
MP RK 170V-Ad-Ad	97 10 31	90
MP RK 170V-Ad-Ad-Pg	97 10 45	92
MP RK 170V-Ad-Pg	97 10 38	91
MP RK 24V-Ad-Ad	97 10 27	89
MP RK 24V-Ad-Ad-Pg	97 10 41	91
MP RK 24V-Ad-Pg	97 10 34	90
MP RK 36V-Ad-Ad	97 10 28	89
MP RK 36V-Ad-Ad-Pg	97 10 42	91
MP RK 36V-Ad-Pg	97 10 35	90
MP RK 48V-Ad-Ad	97 10 29	90
MP RK 48V-Ad-Ad-Pg	97 10 43	92
MP RK 48V-Ad-Pg	97 10 36	91
MP RK 5V-Ad-Ad	97 10 25	89
MP RK 5V-Ad-Ad-Pg	97 10 39	91
MP RK 5V-Ad-Pg	97 10 32	90
MP RK 60V-Ad-Ad	97 10 30	90
MP RK 60V-Ad-Ad-Pg	97 10 44	92
MP RK 60V-Ad-Pg	97 10 37	91
MP RK GDT	97 10 03	84
MP RK GDT+12V-Ad-Ad	97 10 05	86
MP RK GDT+12V-Ad-Ad-Pg	97 10 19	85
MP RK GDT+12V-Ad-Pg	97 10 12	87
MP RK GDT+170V-Ad-Ad	97 10 10	87
MP RK GDT+170V-Ad-Ad-Pg	97 10 24	86
MP RK GDT+170V-Ad-Pg	97 10 17	88
MP RK GDT+24V-Ad-Ad	97 10 06	86
MP RK GDT+24V-Ad-Ad-Pg	97 10 20	85
MP RK GDT+24V-Ad-Pg	97 10 13	87
MP RK GDT+36V-Ad-Ad	97 10 07	86
MP RK GDT+36V-Ad-Ad-Pg	97 10 21	85
MP RK GDT+36V-Ad-Pg	97 10 14	87
MP RK GDT+48V-Ad-Ad	97 10 08	87
MP RK GDT+48V-Ad-Ad-Pg	97 10 22	86
MP RK GDT+48V-Ad-Pg	97 10 15	88
MP RK GDT+5V-Ad-Ad	97 10 04	86
MP RK GDT+5V-Ad-Ad-Pg	97 10 18	85
MP RK GDT+5V-Ad-Pg	97 10 11	87
MP RK GDT+60V-Ad-Ad	97 10 09	87
MP RK GDT+60V-Ad-Ad-Pg	97 10 23	86
MP RK GDT+60V-Ad-Pg	97 10 16	88
MP RK-AB	97 10 02	86
MSR-M20-24V	97 20 11	93
MSR-M20-24V-Fine	97 20 12	93
MTH 230	95 15 01	106
MTH 90	95 15 00	106
MTL 230	95 15 03	106
MTL 90	95 15 02	106
MW-AntPro	17 01 66	126
NM 220V/20kA	36 20 22	49
NM 220V/20kA/PK	36 20 23	49
NM 220V/5kA	36 05 22	49



Product	Article-No.	Page	Product	Article-No.	Page	Product	Article-No.	Page
PLPro-40A-IV	55 04 40	170	PP BC TT 25/100	37 39 20	20	PP PV 800	37 44 00	54
PLPro-80A-IV	55 04 41	170	PP BC TT 25/100/FM	37 39 22	20	PP PV 800/FM	37 44 01	54
PowerPro BCD-Tr/25kA	37 38 50	31	PP BC TT 25/100/FM-350	38 51 70	20	PV AC-DC 1.1-1000	80 00 33	188
PowerPro BCD-Tr/25kA/PK	37 38 60	31	PP BC TT 25/100-350	38 51 60	20	PV AC-DC 1.1-800	80 00 31	188
PowerPro-B-Tr/50kA/Pk	37 38 40	14	PP BC TT1+1 25/100	38 11 32	20	PV AC-DC 1.2-800	80 00 34	188
PP B 25-760	37 45 20	14	PP BC TT1+1 25/100/FM	38 11 33	20	PV AC-DC 3.1-1000	80 00 32	188
PP B 25-760/FM	37 45 21	14	PP BC TT1+1 25/100/FM-350	38 52 10	20	PV AC-DC 3.3-1000	80 00 35	188
PP B IT 50/100	37 39 18	14	PP BC TT1+1 25/100-350	38 52 00	20	PV DC 1/1 1xT1+2 1000V/MC4	80 00 92	191
PP B IT 50/100/FM	37 39 19	14	PP BCD 25-350	37 38 88	31	PV DC 12	80 01 70	190
PP B TN 440	37 39 45	13	PP BCD 25-350/FM	37 38 89	31	PV DC 12.1000-2	80 00 30	190
PP B TN 440/FM	37 39 46	13	PP BCD 27kA	37 38 55	32	PV DC 12.800-2	80 00 23	190
PP B TN 50/100	38 12 10	13	PP BCD 27kA/FM	37 38 65	32	PV DC 2.800-2	80 00 26	181
PP B TN 50/100/FM	38 12 11	13	PP BCD 27kA/FM-350	37 38 68	32	PV DC 2x2 1000V/30A	80 01 67	186
PP B TNC 440	37 39 64	13	PP BCD 27kA-350	37 38 58	32	PV DC 2x3 1000V/30A	80 01 69	186
PP B TNC 440/FM	37 39 65	13	PP BCD TN 25/50	38 12 14	31	PV DC 3.800-3	80 00 39	185
PP B TNC 50/100	37 39 70	12	PP BCD TN 25/50/FM	38 12 15	31	PV DC 3.800-3-S2	80 00 43	185
PP B TNC 50/100/FM	37 39 72	12	PP BCD TN 25/50/FM-350	38 50 70	31	PV DC 4	80 01 01	189
PP B TNC 50/100/FM-350	37 41 15	13	PP BCD TN 25/50/LED	37 12 00	31	PV DC 4.1000-2	80 00 27	189
PP B TNC 50/100-350	37 41 10	13	PP BCD TN 25/50/LED/FM	37 12 02	31	PV DC 4.1000-2-S1	80 00 82	178
PP B TNS 440	37 39 43	12	PP BCD TN 25/50/LED/FM-350	38 51 10	31	PV DC 5.1000 T1+T2	80 01 65	189
PP B TNS 440/FM	37 39 44	12	PP BCD TN 25/50/LED-350	38 51 00	31	PV DC 8.800-8	80 00 56	185
PP B TNS 50/100	37 39 40	12	PP BCD TN 25/50-350	38 50 60	31	PV DC 9	80 01 71	190
PP B TNS 50/100/FM	37 39 42	12	PP BCD TNC 25/75	37 39 90	29	PV DC 9.1000	80 00 29	190
PP B TNS 50/100/FM-350	37 41 25	12	PP BCD TNC 25/75/FM	37 39 92	29	PV DC 9.800	80 00 28	190
PP B TNS 50/100-350	37 41 20	12	PP BCD TNC 25/75/FM-350	38 50 10	29	SGO 350	47 22 13	159
PP B TT 50/100	37 39 10	13	PP BCD TNC 25/75-350	38 50 00	29	SGO 350 QA	47 21 11	161
PP B TT 50/100/FM	37 39 12	13	PP BCD TNC 75/LED	37 39 56	32	SGO 350 QA-S	47 21 12	161
PP B TT 50/100/FM-350	37 41 35	13	PP BCD TNC 75/LED/FM	37 39 57	32	SGO 70	47 21 17	159
PP B TT 50/100-350	37 41 30	13	PP BCD TNS 25/100	37 39 60	29	SGO 70 QA	47 21 04	161
PP B TT1+1 50/100	38 11 30	13	PP BCD TNS 25/100/FM	37 39 62	29	SGO 70 QA-S	47 21 05	161
PP B TT1+1 50/100/FM	38 11 31	13	PP BCD TNS 25/100/FM-350	38 50 30	29	SP BC NPE 100	37 38 23	21
PP B TT2+1 50/100	37 39 15	13	PP BCD TNS 25/100-350	38 50 20	29	SP BC NPE 100/FM	37 38 24	21
PP B TT2+1 50/100/FM	37 39 17	13	PP BCD TT 100/LED	37 39 58	32	ST-D 1200	17 01 20	192
PP BC 50-440	37 45 00	22	PP BCD TT 100/LED/FM	37 39 59	32	ST-D 1200-500	17 01 21	192
PP BC 50-440/FM	37 45 01	22	PP BCD TT 25/100	37 39 30	30	ST-Si/10A	17 01 53	192
PP BC TN 25/50	38 12 12	20	PP BCD TT 25/100/FM	37 39 32	30	ST-Si/12A	17 01 54	192
PP BC TN 25/50/FM	38 12 13	20	PP BCD TT 25/100/FM-350	38 50 50	30	ST-Si/15A	17 01 55	192
PP BC TN 25/50/FM-350	38 51 90	20	PP BCD TT 25/100-350	38 50 40	30	ST-Si/20A	17 01 56	192
PP BC TN 25/50-350	38 51 80	20	PP BCD TT1+1 25/100	38 11 34	30	ST-Si/2A	17 01 50	192
PP BC TNC 25/75	37 39 80	19	PP BCD TT1+1 25/100/2LED	38 11 36	30	ST-Si/4A	17 01 51	192
PP BC TNC 25/75/FM	37 39 82	19	PP BCD TT1+1 25/100/FM	38 11 35	30	ST-Si/8A	17 01 52	192
PP BC TNC 25/75/FM-350	38 51 30	19	PP BCD TT1+1 25/100/FM-350	38 50 90	30	TA 100 C	48 78 14	160
PP BC TNC 25/75-350	38 51 20	19	PP BCD TT1+1 25/100-350	38 50 80	30	TA 500 C	48 78 27	160
PP BC TNC 440	37 39 81	20	PP BCD TT2+1 25/100	37 39 34	30	TC 100 A	48 78 30	162
PP BC TNC 440/FM	37 39 83	20	PP BCD TT2+1 25/100/FM	37 39 36	30	TC 500 A	48 78 50	162
PP BC TNC 50-400/690	37 45 04	22	PP BCD-Tr/25kA/FM-350	37 38 62	31	TelPro LSA 2/10-2E 8x20	24 01 28	107
PP BC TNC 50-400/690/FM	37 45 05	22	PP BCD-Tr/25kA-350	37 38 52	31	TelPro LSA 2/10-2E 8x6	24 01 06	104
PP BC TNS 25/100	37 39 50	19	PP BCD-Tr/25kA-VA	37 38 51	31	TelPro LSA 2/10-3E 8x13	24 01 18	105
PP BC TNS 25/100/FM	37 39 52	19	PP PCD-Tr/25kA-VA/FM	37 38 61	31	TelPro LSA 2/10-3EH230E-10kA	24 01 19	105
PP BC TNS 25/100/FM-350	38 51 50	19	PP PV 1000	37 44 02	54	TelPro LSA 2EY230-20kA	24 01 29	107
PP BC TNS 25/100-350	38 51 40	19	PP PV 1000/FM	37 44 03	54	TelPro LSA-2EH230-10kA	24 01 13	104



PRODUCT REGISTER

ALPHABETICAL

Product	Article-No.	Page
TelPro LSA-2EH230F-10kA	24 01 14	104
TelPro LSA-2EH350-10kA	24 01 16	104
TelPro LSA-2EH90-10kA	24 01 17	104
TelPro LSA-2EL230-20kA	24 01 15	104
TelPro LSA-2EY350-20kA	24 01 32	107
TelPro LSA-2EY90-20kA	24 01 31	107
TelPro LSA-3EH230F1E-10kA	24 01 23	105
TelPro LSA-3EH90E-10kA	24 01 26	105
TelPro LSA-3EH90F1E-10kA	24 01 27	105
TelPro LSA-3EL230E-20kA	24 01 24	105
TelPro LSA-3EL230F1E-20kA	24 01 25	105
TF 100Tr/Th-Pk	53 43 72	164
TF 2000Tr/Th-Pk	55 04 11	164
TF 500-Tr	53 43 98	164
TF 500Tr/Th-Pk	53 43 85	164
TSF 100	44 90 69	158
TSF 100-Tr	44 90 80	165
TSF 50	44 90 60	158
TSF 500	48 78 01	158
TSF 500-Tr	44 90 85	165
TSF 50-Tr	44 90 76	165
TSF-H1	44 91 75	158
UAS 230-Tr	35 10 30	60

AWARDED!



ISO 9001 and 14001

We are certified by TÜV SÜD according to the DIN EN ISO: 9001:2008. Thus we answer all defined requirements and expectations that find us in the form of customer specifications, formalities and other regulations.

In sector development, production and distribution of construction units and devices for lightning and over-voltage protection we have established and applied an Environmental Management System since August 2010. Therefore requirements according to ISO 14001: 2004 are fulfilled



Siemens and VDE



Member of ZVEI.





SURGE PROTECTION FOR POWER SUPPLY SYSTEMS

SURGE PROTECTION FOR MEASURING SYSTEMS AND AUTOMATIC CONTROL DEVICES

SURGE PROTECTION FOR INFORMATION TECHNOLOGY AND TELEKOMMUNCATION

SURGE PROTECTION FOR TRANSMITTING AND RECEIVING SYSTEMS

EMV-FILTER WITH INTEGRATED SURGE PROTECTION

MONITORING

RARE-GAS-FILLED INSULATION SPARK GAPSF

PROTECTIVE DEVICES FOR AC ARRESTING

SURGE PROTECTION OF PV SYSTEMS: GENERATOR CONNECTION BOXES

LEUTRON GMBH

LIGHTNING AND SURGE PROTECTION

HUMBOLDTSTRASSE 30/32

D-70771 LEINFELDEN-ECHTERDINGEN

GERMANY

T: +49-(0)711-94771-0

F: +49-(0)711-94771-70

INFO@LEUTRON.DE

WWW.LEUTRON.DE

WWW.LEUTRON.DE